



The Global Language of Business

GDSN Trade Item Module Library Business Message Standard

Release 3.1.31, Issue 1.4.47, October 2024

Document Summary

Document Item	Current Value
Document Name	GDSN Trade Item Module Library Business Message Standard
Document Date	October 2024
Document Version	3.1.31
Document Issue	Issue 1.4.47
Document Status	

Contributors

First Name	Last Name	Company
Abhishek	Arora	General Mills, Inc.
Adel Mounir	Achir	GS1 France
Agnes	Peres	GS1 Germany
Ahmed	El Kalla	GS1 Egypt
Ahmed	Faraf	GS1 Denmark
Akshay	Koshti	Robert Bosch GmbH
Alec	Tubridy	GS1 Ireland
Aleksandra	Ciric	GS1 Serbia
Alexander	Gerasimenko	Mars, Inc.
ALEXANDER	SANCHEZ	GS1 Mexico
Alexandre	Rieucan	LVMH
Alexey	Krotkov	GS1 Russia
Alexis	Elloso	GS1 Australia
Alice	Nguyen	GS1 Vietnam
Alison	Bartlet	Commport Communications Int'l Inc.
Alison	Willis	Wal-Mart Stores, Inc.
Allison	Fregans	Johnson & Johnson
allison	sheldon	Pfizer
Amanda	Greenwood	Watts Water Technologies, Inc.
Amber	Walls	GS1 US
Amnah	Shaari	Serunai Commerce Sdn Bhd
Ana	Sramek	Mondelez International
Anders	Bruhn Fagerjord	Elkj�p Nordic AS
Andrea	Ausili	GS1 Italy
Andrea	Opatrn�	GS1 Czech Republic
Andrea	Schlossarek	METRO Group
Andrea	Schwotzer	atrify GmbH
Andreas	Schneider	GCS Consulting GmbH
Andree	Berg	GS1 Germany
Andrew	Hearn	GS1 Global Office
Andrew	Tuerk	Syndigo
Andri	Sigur�sson	GS1 Iceland
Andy	Westfa	GS1 Netherlands
Anette	Andersson	ICA Sverige AB



First Name	Last Name	Company
Angela	Bohn	Johnson & Johnson
Angelika	Stahl	METRO Group
Angelina	Tolbert	GS1 US
Anne-Sophie	Huygens	GS1 Belgium & Luxembourg
Anthony	Chan	GS1 Hong Kong, China
Antoine	Mauvoisin	LVMH
Anton	Smolkov	Janssen Pharmaceutica NV
April Anne	Sese	Johnson & Johnson
Ardetha	Bradley	Georgia Pacific
Armand	Schins	Ahold Delhaize
Ashray	Jain	Wal-Mart Stores, Inc.
Audrey	Kelly	GS1 Global Office
Avni	Gupta	Nestlé
Barbara	Wendelin	GS1 Austria
Barry	Glennon	Sam's Club
Belle	Yang	GS1 Chinese Taipei
Ben	Teo	GS1 Australia
Benjamin	Couty	GS1 France
Benjamin	Dieleman	@GP
Benjamin	Herzig	Descartes STEPcom GmbH
Bernard	Faibella	GS1 Global Office
Bijoy	Peter	GS1 India
Björn	Bayard	Bayard GmbH
Bo	Pincket	GS1 Belgium & Luxembourg
bo	Zhou	GS1 China
Bojan	Kovačič	GS1 Slovenia
Brendon	Johnson	GS1 Australia
Brian	Bazara	Wakefern Food Corporation
Bruno	Aceto	GS1 Italy
Burkhard	Lorry	atrify GmbH
Cady	McMaster	Wegmans Food Markets
Carey	Barlett	Teleflex Inc.
Carl	Gomberg	Premier Inc
Carla	Hamrick	Coca-Cola Company (The)
Carlo	Bouw	BOUWKRACT
Caroline	Coutant	Carrefour
Chanelle	Komarasamy	GS1 South Africa
Charles	Hinthorne	ITradeNetwork.com, Inc.
Chase	Cunningham	Wal-Mart Stores, Inc.
Cherise	Allison	Sam's Club
Choon-Ai	Kaiser	Nestlé
Christa	Suc	GS1 UK
Christian	Przybilla	GS1 Germany
Christian	Zaeske	METRO Group
Christine	Chang	3M Healthcare
Christine	McMaster	Wakefern Food Corporation
Chunguang	Wang	GS1 China



First Name	Last Name	Company
Cihan	Korucu	GS1 Türkiye
Clément	Delaunay	Sodexo
Connie	Wong	GS1 Canada
Cornelia	Willutzki	GS1 Switzerland
Cristina	Popescu	Metro Cash & Carry Romania SRL
Dagan	Xavier	Label Insight, Inc.
Damaris	Siqueira	Mars, Inc.
Dana	Benson	GS1 US
Daniel	Zabalet	Commport Communications Int'l Inc.
David	Buckley	GS1 Global Office
David	Burnichon	BioMérieux SA
David	Hackbarth	Procter & Gamble Co.
Delia Claudia	Ionescu	METRONOM GmbH
Di	Wang	GS1 China
Diane	Taillard	GS1 Global Office
Dieter	Beitz	CSB-System SE
Dilip	Daswani	Qliktag Software (formally Zeebric LLC)
Dirk	Beyl	Kaufland Stiftung & Co. KG
Donna	Debenham	Mondelez International
Donna	Hill	Dairy Farmers of America
Dylan	Lippincott	Johnson & Johnson
Ed	Collins	NielsenIQ Brandbank
Ed	Jesus	Chep
Ed	Treacy	Produce Marketing Association (PMA)
Edgardo	Avila	GS1 Mexico
Eduardo Alberto	Remigio Munguia	GS1 Mexico
Edward C	Merrill	GS1 Global Office
Eileen	Harpell	GS1 Global Office
Elena	Tomanovich	GS1 Global Office
Elia	Picelli	GS1 Italy
Elif	Muftuoglu	GS1 Türkiye
Elizabeth	Sertl	GS1 US
Elizabeth	Waldorf	TraceLink
Elizabeth	Wilson	Kellogg Company
Elsa	Braz	GS1 Global Office
Emilie	Tauc	Carrefour
Eno	Dhamo	GS1 Canada
Enrique	Cruz	Helen of Troy
Ephraim	Mokheseng	GS1 South Africa
Eric	Ginsburg	Sazerac Company, Inc.
Erin	Brown	Best Buy Co., Inc.
Ethem	Kamanlı	Migros Ticaret A.Ş
Eugen	Sehorz	GS1 Austria
Fabien	Rouet	BioMérieux SA
Felipe	Leonardo	GS1 Brasil
Felipe	Serrano Sanchez	GS1 Colombia
Felix	Loecher	SAP SE



First Name	Last Name	Company
Fernando	Pereira	Saphety Level SA
Francis	GASCHET	NUMLOG
Francisco	Santonja	EDICOM
Frank	Heemelaar	Albert Heijn
Frank	Hogema	GS1 Netherlands
Frédéric	Maurizot	@GP
Frederik	Jensen	GS1 Denmark
George	Wright IV	Product Identification & Processing Systems
Georges	Nicolaos	Hospital Fondation Adolphe de Rothschild
Georgette	Suggs	Sitation, LLC.
Georgy	Ogandzhanov	GS1 Russia
Gina	Tomassi	PepsiCo, Inc.
Ginger	Green	Wal-Mart Stores, Inc.
GlobalData	Model	GS1 Global Office
Gloria	Castaneda	Mondelez International
Gorkem	Gokmenoglu	GS1 Türkiye
Greg	Buckley	PepsiCo, Inc.
Greg	Rowe	GS1 Global Office
GSMP	Calendar	GS1 Global Office
Guido	Porting	Bayard GmbH
Guillaume	DEJAILLE	EQUADIS SA
Guillaume	Ledeun	GS1 France
Guitta	EL ALAM	EQUADIS SA
Hannu	Lehtonen	GS1 Finland
Hans	Lunenburg	GS1 Netherlands
Haris	Poturković	GS1 Bosnia and Herzegovina
Heiner	Lehr	Syntesa ApS
Helen	Barlow	Dairy Farmers of America
Helene	Bernhard	Nestlé
Henk-Jan	Timmerman	GS1 in Europe
Hideki	Ichihara	GS1 Japan
Holger	Joest	Bayard GmbH
Holger	Thiemann	atrify GmbH
Huang	Xin	GS1 China
Hugh	McBride	Syndigo
Hussam	El-Leithy	GS1 US
Iliada	Karali	GS1 Association Greece
Ilteris	Oney	atrify GmbH
Inge	Duijf	SuperUnie
Iveta	Jagelková	GS1 Slovakia
Ivo	Hristov	Coca Cola European Partners
James	Chronowski	GS1 US
Jan	Schimmel	GS1 Netherlands
Jan	Somers	GS1 Belgium & Luxembourg
Janet	Chin	GS1 Canada
János	Gyuris	GS1 Hungary
Jason	Lavik	Target Corporation



First Name	Last Name	Company
Jay	Crowley	US Data Management, LLC (USDMD)
Jean-Marc	Klopfenstein	Nestlé
Jeanne	Duckett	Avery Dennison RFID
Jeffrey	Cree	Ahold (USA)
Jennie	Stitzinger	GS1 US
Jenny	Dorbin	Kellogg Company
Jens	Weller	Salsify
Jerry	Tracey	GS1 Netherlands
Jesper Kervin	Franke	GS1 Denmark
Jessica	Edmondson	The J.M. Smucker Company
Jessica	Horst	The J.M. Smucker Company
Jessica	Hughes	Wakefern Food Corporation
Jessica	Johnston	Kwikee, A Syndigo Company
Jiangfeng	Qiu	GS1 China
JIAYI	WANG	GS1 China
Joel	Oberdieck	Kwikee, A Syndigo Company
Johan	den Engelse	GS1 Netherlands
Johana	Garcia	Logyca
Johanna	Londono	GRUPO EXITO
Johannes	Gollowitzer	Mars, Inc.
John	Apicella	Salsify
John	Fitzpatrick	Syncnicity for US Department of Defense
John	Lane	GS1 Australia
John	Ryu	GS1 Global Office
Jolanda	Buijs	Erasmus MC
Jolanta	Gorniak	Mondelez Europe Services GmbH
Jolyn	van der Beek	GS1 Netherlands
Jonas	Andersson	Ikea
Jonas	Ekestam	Pinestone AB
Jonathan	Bemrose	R&R Ice Cream
José	Leite	Saphety Level SA
José Ramón	Islas	GS1 Mexico
Josee	Gladu	GS1 Canada
Juan Pablo	Gomez Sepulveda	GS1 Mexico
Julie	McGill	FoodLogiQ
Juliet	Luther	Safeway
Juliet Andrea	Espinosa Martinez	GS1 Colombia
Julius	Sieg	METRO Group
k	van der meulen	Bravis ziekenhuis
Kamilla	Kurmanova	GS1 Russia
Karen	Specht	KISS Products, Inc.
Karina	Danielsson	GS1 Sweden
Karmik	Shah	Kevision
Kate	Thiruchelvam	Mondelez International
Kathrin	Kiesel	Henkel AG. & Co. KGaA
Kathy	Welch	Wegmans Food Markets
Katie	Hasselbeck	Procter & Gamble Co.



First Name	Last Name	Company
Katrin	Nunez	Descartes
KAYLA	LEWIS	Sam's Club
Kenneth	Jørgensen	GS1 Denmark
Kevin	Carroll	Procter & Gamble Co.
Kira	Petters	REWE Group
Klaus	Foerderer	GS1 Germany
Knut	Mathisen	GS1 Norway
Krisztina	Vatai	GS1 Hungary
Krzysztof	Muszynski	GS1 Poland
Laura	Creekmore	Syndigo
Laura Merce	Bermudez	GS1 UK
Laurent	BRAUD	AGENA 3000 DATA MANAGEMENT
Laurent	Seroux	Procter & Gamble Co.
Lautaro	Escudero	GS1 Argentina
Lei	Wang	GS1 China
Lena	Grönlund	GS1 Sweden
Lexi	Van Houten	Ventura Foods, LLC
Linda	Conniff	Best Buy Co., Inc.
Lindsey	Kobow	Target Corporation
Lori	Schrop	GS1 Global Office
Louise	Nordin	GS1 Sweden
Lucelena	Angarita	GS1 US
Luiz	Costa	GS1 Brasil
Lynn	Nathe	Nestlé
Maarten	Marrant	GS1 Belgium & Luxembourg
Madalina	Cernat	GS1 Romania
Maik	Sippl	atrify GmbH
Maju	Nair	GS1 New Zealand
Manos	Papadakis	GS1 Association Greece
mao	feng ming	GS1 China
Mao	Nagata	GS1 Japan
Marc	Blanchet	Viagenie
Marc	Gale	GS1 Global Office
Marc	Koenig	METRO Group
Marcel	Sieira	GS1 Australia
Marcel	Yska	Ahold Delhaize
Marco	Mueller-Hess	Bison Schweiz AG
Marcus	Moritz	GS1 Germany
Margaret	Thompson	PepsiCo Beverages Canada
Margarita	Bykova	GS1 Russia
Maria Francesca	Imbrogno	GS1 Italy
Marianne	Timmons	GS1 Global Office
Marie	Burnay	GS1 Global Office
Marie	Hamerníková	GS1 Czech Republic
Marija	Andjelkovic	Mondelez International
Marina	Lopes	Johnson & Johnson Consumer UK Ltd.
Marinus	Bouwman	IVII GmbH, KNAPP Vision Technology Company



First Name	Last Name	Company
Mario	Aguirre	GS1 El Salvador
Marisa	Lu	GS1 Chinese Taipei
Mark	Koolen	Solventum
Mark	Oetlinger	Syndigo
Mark	Van Eeghem	GS1 Global Office
Markus	Mueller	GS1 Global Office
Martin	Kairu	GS1 South Africa
Maryam	Mirza	GS1 Global Office
Mats	Bjorkqvist	GS1 Sweden
Matthew	Hays	Vistex, Inc.
Matthias	Bug	GS1 Germany
Mauricio	Vazquez	Colgate-Pamolive
Maxim	Stafeev	SKB Kontur
Meenu	Kumari	Wal-Mart Stores, Inc.
Mehmet	Uyaroglu	Migros-Genossenschafts-Bund
Melanie	Nuce	GS1 US
Melissa	Veldman-Broekhuizen	GS1 Netherlands
Menno	Flantua	SuperUnie
Michael	Crabb	Syndigo
Michal	Horák	Nestlé
Michele	Francis Padayachee	GS1 South Africa
Michele	Larson	The Schwan Food Company
Mickey	Atkins	Ahold (USA)
Micol	Vialetto	GS1 Italy
Mike	Durning	Wakefern Food Corporation
Milan	Vacval	Koch Foods
Mirva	Alatypö	GS1 Finland
MJ	Wylie	Johnson & Johnson
Morten	Buch	GS1 Denmark
Murray	Robb	GS1 Australia
Nadja	Minich	GS1 Global Office
Natalia	Casas	Nestlé
Nathan	Stonewall	GS1 Sweden
Neil	Gray	GS1 UK
Nicolas	Collignon	GS1 Global Office
Nicolas	Frerejean	GS1 Global Office
Nicole	Golestani	GS1 Canada
Nicolette	Pratt	Ahold (USA)
Nordine	Eddaoudi	GS1 France
Nuno	Azevedo	GS1 Portugal
Olga	Soboleva	GS1 Russia
Olivar	Rodén	GS1 Denmark
Oscar	Cruz	GS1 Mexico
Palma	Simbari	Bayer AG - Division Pharma
Pam	Klein	Procter & Gamble Co.
Pascal	Aulagnet	Pfizer
Patricia	Perrier	Bayard GmbH



First Name	Last Name	Company
Patrick	Li	GS1 Hong Kong, China
Patrick	Menzi	Coop Genossenschaft
Patrick	Ponsaerts	GS1 Belgium & Luxembourg
Patrik	Jonasson	GS1 Global Office
Paul	Boulaud	GS1 France
Paul	Kunkeler	Nestlé Netherlands B.V.
Paula	Metoxen	Kimberly-Clark Corporation
Paulo	Barata	GS1 Global Office
Pavla	Cihlarova	GS1 Czech Republic
Pebbles	Little	Charlotte Pipe and Foundry Company
Pedro	Lima	GS1 Portugal
Penny	Hernandez	Dean Foods Company
Pere	Rosell Plajats	GS1 Spain
Pete	Alvarez	GS1 Global Office
Peter	Jönsson	GS1 Sweden
Peter	Zaepfel	Mondelez International
Petr	Beran	Albert Česká Republika s r.o.
Petra	Bodemer	dm drogerie markt GmbH & Co. KG
Phil	Cooper	NielsenIQ Brandbank
Phillip	Bocci	Ecolab
Phuong	Cao	GS1 Germany
Phyllis	Koch	The Schwan Food Company
Pieter	Timmermans	Heineken
Prakash	Mahar	Kevision
Prince	Namane	GS1 South Africa
Priyanka	Rajvanshi	IPC/SUBWAY
Rajiv	Singh	Garud Technology Services Inc
Raquel	Abrantes	GS1 Portugal
Ravi Kiran	Unnam	Mondelez International
Rebecca	Nichols	Wakefern Food Corporation
Reiko	Moritani	GS1 Japan
Reine	Strömstedt	ReadSoft Expert Systems
Remco	Krol	GS1 Netherlands
Riad	Mechtari	GS1 Algeria
Ricardo	Verza Amaral Melo	GS1 Brasil
Rita	Laur	GS1 Canada
Rob	Hoffman	Hershey Company (The)
Robert	Beideman	GS1 Global Office
Robert	Besford	GS1 UK
Robert	Celeste	Center for Supply Chain Studies
Robin	Goossens	GS1 Belgium & Luxembourg
Robin	Widberg	GS1 Sweden
Roel	Geleijnse	Unilever N.V.
Roman	Strand	GS1 Germany
Ronald	Bartnik	Procter & Gamble Co.
Rose	Campasano	LSPediA
Rose	DeLuca	Mondelez International



First Name	Last Name	Company
Roxana	Saravia Bulmini	GS1 Argentina
Ruediger	Hagedorn	The Consumer Goods Forum
Ruoyun	Yan	GS1 China
Sabine	Helssen	Nestlé
Saeed	Shams	Commport Communications Int'l Inc.
Sally	McKinley	GS1 US
Sandra	Michel	Franciscan Missionaries Of Our Lady Health System
Sandra Isabel	Hernandez Amador	GS1 Mexico
Sara	Halfmann	Best Buy Co., Inc.
Sara	Petersson	GS1 Sweden
Sarah	Ellenbogen	Digiphy
Sarah	Lard	GS1 Belgium & Luxembourg
Sascha	Kasper	atrify GmbH
Scott	Brown	1WorldSync, Inc.
Sean	Dennison	GS1 Ireland
Sean	Lockhead	GS1 Global Office
Seán	Lightholder	Wal-Mart Stores, Inc.
Sebastián	Rivarola	Eway
Selcuk	Övüc	GS1 Germany
Sergio	Pastrana	GS1 Mexico
Sheree	Delice	Nestlé (US)
Shi	Yu	Beijing REN JU ZHI HUI Technology Co. Ltd.
Shogo	s-takano	GS1 Japan
Sietse	Houtman	GS1 Netherlands
SILVÉRIO	PAIXÃO	GS1 Australia
Siobhain	Duggan	GS1 Ireland
Sofia	Salcedo	Logyca
Sonya	Thomas	Sam's Club
Sophie-Mareen	Scholz	Dr. August Oetker Nahrungsmittel KG
Stacy	Donnenwerth	Kellogg Company
Staffan	Olsson	GS1 Sweden
Stefan	Artlich	Bayer AG - Division Pharma
Stefan	Gathmann	GS1 Ireland
Stephanie	Tibbs	Procter & Gamble Co.
Stephanie	van Rossum	GS1 Global Office
Stephen	Howard	GS1 Global Office
Steven	Keddie	GS1 Global Office
steven	nelson	Tyson
Steven	Robba	GS1 Global Office
Sujitha	Pothiraj	Wal-Mart Stores, Inc.
Susanta	Sahu	GS1 Canada
Suzy	Sönmez	Ikea
Sylvia	Rubio Alegren	ICA Sverige AB
Sylvia	Stein	GS1 Netherlands
Tadashi	Dobeta	GS1 Japan
Tamas	Kasza	SAP SE
Tanja	Thomsen	GS1 Germany



First Name	Last Name	Company
Tasha	Wiehe	GS1 Global Office
Ted	Calmius	OPV In-Store Promotion AB
Tessa	Düren	GS1 Netherlands
Thea	Bourianne	Label Insight, Inc.
Theresa	McLaughlin	Mars, Inc.
Thiago	Perez Rojas	GS1 Argentina
Ting Jie	Shen	GS1 China
Tom	Jones	Johnson & Johnson
Tom Eric	Schmidt	August Storck KG
Tomas	Tluchor	GS1 Czech Republic
Tomi	Ihalainen	GS1 Finland
Toni	Baxter Juenger	Procter & Gamble Co.
Tracy	Scott	Wal-Mart Stores, Inc.
Vanessa	Giulieri	GS1 Italy
Veronika	Chudomelová	GS1 Slovakia
Vibhor	Mathur	Wal-Mart Stores, Inc.
Victor	Ortiz	GS1 Mexico
Victor	Zhang	GS1 China
Vivian	Salim	GS1 Germany
Vivian	Underwood	GS1 US
wayne	Luk	GS1 Hong Kong, China
Wendy	Jackson	Boston Scientific Corporation
Wenyu	Wang	GS1 China
WESOLOWSKI	CLAUDE	Johnson & Johnson
Xavier	Pujol Xargay	GS1 Spain
Xiaojiao	Lv	GS1 China
Yan	Luo	GS1 China
Yi	Wang	GS1 China
Ying	YU	GS1 China
ying	zhang	GS1 China
Yingxi	Yang	GS1 China
Yiyuan	Li	GS1 China
Yomi	Oladokun	GS1 Netherlands
Yoshihiko	Iwasaki	GS1 Japan
Yuki	Sato	GS1 Japan
Yukiko	Yamashita	DENSO WAVE Incorporated
Yvonne	Hoeting	Mars, Inc.
Zachary	Garrison	Abbott
Zbigniew	Rusinek	GS1 Poland
Zeynep	Parlak	GS1 Türkiye
Zoltan	Homan	Cook Medical Inc.
Zubair	Nazir	GS1 Canada

Log of Changes

Release	Date of Change	Changed By	Summary of Change
1.0.4	30 Jun 2013	Eric Kauz	Comment Resolution
1.0.4	30 Aug 2013	Eric Kauz	eBallot/Errata
1.0.5	20 Jan 2013	Eric Kauz	eBallot/Errata
1.0.6	20 Aug 2014	Eric Kauz	Round 3 Changes
1.0.8	20 Nov 2014	Eric Kauz	Round 3 Changes
1.0.9	20 Aug 2015	Eric Kauz	Errata
1.1.0	05 Oct 2015	Eric Kauz	December 2015 ECL
1.1.1	15 Feb 2015	Eric Kauz	Maintenance Release
1.1.3	23 Aug 2016	Eric Kauz	Minor Errata (see change summary)
1.1.4	04 Jan 2017	Eric Kauz	LCL Release
1.1.5	12 Jan 2017	Eric Kauz	3.1.3 Release
1.1.7	12 July 2017	Eric Kauz	3.1.4 Release
1.1.8	05 Sept 2017	Eric Kauz	Community Review (see change summary)
1.1.11	06 Mar 2018	Eric Kauz	3.1.6 Eballot
1.1.12	07 Mar 2018	Eric Kauz	3.1.7
1.1.14	20 Jul 2018	Eric Kauz	3.1.7
1.2	25 Jul 2018	Eric Kauz	3.1.8
1.3	24 Oct 2018	Eric Kauz	3.1.8 Community Review
1.3.1	26 Nov 2018	Eric Kauz	3.1.8 eBallot.
1.4.0	6 Feb 2019	Mark Van Eeghem	3.1.9
1.4.1	8-Mar-2019	Mark Van Eeghem	3.1.9 Community Review
1.4.2	12-Mar-2019	Mark Van Eeghem	3.1.9 Community Review
1.4.3	29-Mar-2019	Mark Van Eeghem	XML Developer Comments
1.4.4	4-Apr-2019	Mark Van Eeghem	eBallot Comments
1.4.6 & 1.4.7	11-Apr-2019	Mark Van Eeghem	eBallot Comments
1.4.8	2-Jul-2019	Radhika Chauhan	Initial Draft of 3.1.10
1.4.9	18-Jul-2019	Radhika Chauhan	Updates based on XML Developer comments
1.4.10	29-Jul-2019	Mark Van Eeghem	Updates based on community review comments
1.4.11	9-Sept-2019	Radhika Chauhan	Updates based on eBallot comments
1.4.12	18-Dec-2019	Radhika Chauhan	Initial Draft of 3.1.12
1.4.13	03-Jan-2020	Radhika Chauhan	Updates based on community review comments
1.4.14	27-Jan-2020	Radhika Chauhan	Initial Draft for 3.1.13
1.4.15	17-Mar-2020	Radhika Chauhan	Updates based on Community Review Comments
1.4.15	19-Mar-2020	Radhika Chauhan	Updates based on Community Review Comments
1.4.16	9-April-2020	Maryam Mirza	Initial Draft for 3.1.14
1.4.17	28-May-2020	Maryam Mirza	Updates based on Community Review Comments
1.4.18	22-June-2020	Maryam Mirza	Updates based on eBallot comments
1.4.19	4-Aug-2020	Maryam Mirza	Updates based on Community Review Comments
1.4.20	31-Aug-2020	Maryam Mirza	Updates based on eBallot comments
1.4.21	10-Spet-2020	Maryam Mirza	Initial Draft 3.1.15 and EUDAMED



Release	Date of Change	Changed By	Summary of Change
1.4.22	24-Feb-2021	Maryam Mirza	Updates based on eBallot comments
1.4.23	24-Feb-2021	Maryam Mirza	Updates based on Community Review Comments
1.4.24	22-Mar-2021	Maryam Mirza	Initial Draft 3.1.16
1.4.25	20-May-2021	Maryam Mirza	Updates based on Community Review Comments
1.4.26	21-June-2021	Maryam Mirza	Initial Draft 3.1.16
1.4.27	12-July-2021	Maryam Mirza	Updates based on Community Review Comments
1.4.28	21-Oct-2021	Maryam Mirza	Initial Draft 3.1.19
1.4.29	1-Dec-2021	Maryam Mirza	Updates based on Community Review Comments
1.4.30	17-Feb-2022	Maryam Mirza	Initial Draft 3.1.20
1.4.31	11-Apr-2022	Maryam Mirza	Updates based on Community Review Comments
1.4.31	1-Jun-2022	Maryam Mirza	Initial Draft 3.1.21
1.4.33	25-July-2022	Maryam Mirza	Updates based on Community Review Comments
1.4.34	5-Oct-2022	Maryam Mirza	Initial Draft 3.1.22
1.4.35	3-Nov-2022	Maryam Mirza	Initial Draft 3.1.23
1.4.38	6-Mar-2023	Maryam Mirza	Initial Draft 3.1.24
1.4.39	11-May-2023	Maryam Mirza	Initial Draft 3.1.25
1.4.40	28-June-2023	Maryam Mirza	Updates based on Community Review Comments
1.4.41	27-July-2023	Maryam Mirza	Initial Draft 3.1.26
1.4.42	24-Oct-23	Maryam Mirza	Initial Draft 3.1.27
1.4.43	22-Feb-24	Maryam Mirza	Updates based on Community Review Comments
1.4.44	22-Mar-24	Maryam Mirza	Initial Draft 3.1.28
1.4.45	14-May-24	Maryam Mirza	Initial Draft 3.1.29
1.4.46	1-Aug-24	Maryam Mirza	Initial Draft 3.1.31
1.4.47	29-Oct-24	Maryam Mirza	Updates based on Community Review Comments



Disclaimer

GS1®, under its IP Policy, seeks to avoid uncertainty regarding intellectual property claims by requiring the participants in the Work Group that developed this **GDSN Trade Item Module Library Business Message Standard** to agree to grant to GS1 members a royalty-free licence or a RAND licence to Necessary Claims, as that term is defined in the GS1 IP Policy. Furthermore, attention is drawn to the possibility that an implementation of one or more features of this Specification may be the subject of a patent or other intellectual property right that does not involve a Necessary Claim. Any such patent or other intellectual property right is not subject to the licencing obligations of GS1. Moreover, the agreement to grant licences provided under the GS1 IP Policy does not include IP rights and any claims of third parties who were not participants in the Work Group.

Accordingly, GS1 recommends that any organization developing an implementation designed to be in conformance with this Specification should determine whether there are any patents that may encompass a specific implementation that the organisation is developing in compliance with the Specification and whether a licence under a patent or other intellectual property right is needed. Such a determination of a need for licencing should be made in view of the details of the specific system designed by the organisation in consultation with their own patent counsel.

THIS DOCUMENT IS PROVIDED "AS IS" WITH NO WARRANTIES WHATSOEVER, INCLUDING ANY WARRANTY OF MERCHANTABILITY, NONINFRINGEMENT, FITNESS FOR PARTICULAR PURPOSE, OR ANY WARRANTY OTHERWISE ARISING OUT OF THIS SPECIFICATION. GS1 disclaims all liability for any damages arising from use or misuse of this Standard, whether special, indirect, consequential, or compensatory damages, and including liability for infringement of any intellectual property rights, relating to use of information in or reliance upon this document.

GS1 retains the right to make changes to this document at any time, without notice. GS1 makes no warranty for the use of this document and assumes no responsibility for any errors which may appear in the document, nor does it make a commitment to update the information contained herein.

GS1 and the GS1 logo are registered trademarks of GS1 AISBL.

Table of Contents

1	Business Domain View	18
1.1	Objective	18
1.2	Audience.....	18
1.3	References	18
1.4	Document Conventions	18
2	Business Context	18
3	GDSN Common.....	19
3.1	Enumeration.....	19
3.2	Code	20
3.3	Compound Data Type	21
3.3.1	Formatted Description	22
3.3.1	Language Optional Description	24
3.4	Additional Trade Item Dimensions	24
3.5	Additive Information.....	26
3.6	Aspect Ratio Information.....	26
3.7	Catalogue Item Reference	27
3.8	Certification Information	29
3.9	Country	31
3.10	External Code Value Information.....	32
3.11	Farming and Processing Information.....	34
3.12	GS1 Attribute Value Pair List.....	36
3.13	GDSN Trade Item Classification Attribute	40
3.14	Hazardous Information Header	41
3.15	Incoterm Information	46
3.16	Organic Information	47
3.17	Party In Role	49
3.18	Place Of Product Activity	50
3.19	Referenced File Information.....	52
3.20	Registration Information	55
3.21	Structured Address.....	56
3.22	Trade Item Material.....	57
4	Core Item	59
4.1	Trade Item.....	59
4.2	GDSN Trade Item Classification	69
4.3	Referenced Trade Item	73
4.4	Trade Item Contact Information.....	74
4.5	Trade Item Synchronisation Dates.....	77
5	Trade Item Modules.....	79
5.1	Alcohol Information Module	79
5.2	Allergen Information Module.....	84
5.3	Animal Feeding Module	87
5.4	Apparel Information Module	91
5.5	Audience Or Player Information Module.....	93
5.6	Audio Visual Media Content Information Module.....	95



5.7 Audio Visual Media Product Description Information Module..... 99

5.8 Audio Visual Media Production Information Module102

5.9 Award Prize Module104

5.10 Battery Information Module106

5.11 Certification Information Module109

5.12 Chemical Regulation Information Module.....110

5.13 Child Nutrition Information Module115

5.14 Consumer Instructions Module117

5.15 Controlled Substances Module120

5.16 Copyright Information Module.....122

5.17 Dairy Fish Meat Poultry Item Module124

5.18 Dangerous Substance Information Module.....131

5.19 Delivery Purchasing Information Module135

5.20 Diet Information Module140

5.21 Durable Goods Characteristics Module142

5.22 Duty Fee Tax Information Module.....144

5.23 Electronic Device Characteristics Information Module.....148

5.24 Farming And Processing Information Module.....156

5.25 Food And Beverage Ingredient Module159

5.26 Food and Beverage Preparation Serving Module164

5.27 Food and Beverage Properties Information Module168

5.28 Health Related Information Module.....172

5.29 Health Wellness Packaging Marking Module176

5.30 Healthcare Item Information Module.....178

5.31 Lighting Device Module184

5.32 Marketing Information Module188

5.33 Material Module194

5.34 Medical Device Trade Item Module197

5.35 Movie Revenue Information Module206

5.36 Nonfood Ingredient Module208

5.37 NonGTIN Logistics Unit Information Module211

5.38 Nutritional Information Module.....213

5.39 ONIX Publication File Information Module218

5.40 Optics Device Information Module241

5.41 Organism Classification Module243

5.42 Packaging Information Module245

5.43 Packaging Marking Module261

5.44 Packaging Sustainability Module.....266

5.45 Pharmaceutical Item Information Module285

5.46 Physical Resource Usage Information Module.....288

5.47 Place of Item Activity Module290

5.48 Plumbing HVAC Pipe Information Module.....292

5.49 Product Characteristics Module295

5.50 Product Formulation Statement Module.....297

5.51 Product Information Module.....302

5.52 Promotional Item Information Module318

5.53 Propellant Information Module320

5.54 Publication Title Rating Module.....321

5.55 Referenced File Detail Information Module.....323

5.56 Regulated Trade Item Module329



- 5.57 Safety Data Sheet Module333
- 5.58 Sales Information Module.....352
- 5.59 Security Tag Information Module.....361
- 5.60 Software System Requirements Module363
- 5.61 Sustainability Module.....365
- 5.62 Trade Item Data Carrier And Identification Module370
- 5.63 Trade Item Description Module373
- 5.64 Trade Item Disposal Information Module378
- 5.65 Trade Item Handling Module.....381
- 5.66 Trade Item Hierarchy Module.....383
- 5.67 Trade Item Humidity Information Module385
- 5.68 Trade Item Licensing Module388
- 5.69 Trade Item Lifespan Module391
- 5.70 Trade Item Measurements Module.....393
- 5.71 Trade Item Size Module399
- 5.72 Trade Item Temperature Information Module.....401
- 5.73 Transportation Hazardous Classification Module404
- 5.74 Variable Trade Item Information Module407
- 5.75 Video Display Device Information Module409
- 5.76 Warranty Information Module413

- 6 Codes..... 415**
 - 6.1 GS1 Managed Codes.....415
 - 6.2 Attributes with Code Lists Not Specified in Models415

- 7 Implementation Considerations..... 417**
 - 7.1 Attribute Variations Last two columns are used strictly for attributes with Languages, Measurements and Currencies417
 - 7.2 Divergence of section 7.1 (Class or Module variation) for TPN/TPD455
 - 7.3 Measurement Rules (Music and Film Publishing Industries).....456
 - 7.4 GTIN Allocation Rules for Ingredient and Allergen Information457
 - 7.5 Deleted Attributes458

- 8 Appendices 460**
 - 8.1 Understanding Data Type Class Diagrams460
 - 8.2 Usage Disclaimer for The Unified Code for Units of Measure (UCUM)460

- 9 Summary of Changes 461**

1 Business Domain View

1.1 Objective

To populate the GS1 Global Registry and report to data pools and their registered trading partners up to date data source party information.

1.2 Audience

The audience of this standard is any participant in the global supply chain. This includes retailers, manufacturers, service providers and other third parties.

1.3 References

Reference Name	Description
BRAD For Major Release	

1.4 Document Conventions

Wherever in this document text is marked in red, it means this is a change compared to the previous version of the GDSN Release.

Wherever in this document text is marked in green, it means this is a document only change compared to a previous version of the document, but not impacting the GDSN Release.

2 Business Context

Context Category	Value(s)
Industry	All
Geopolitical	All
Product	All
Process	Distribute Product Information
System Capabilities	GDSN
Official Constraints	None

3 GDSN Common

3.1 Enumeration

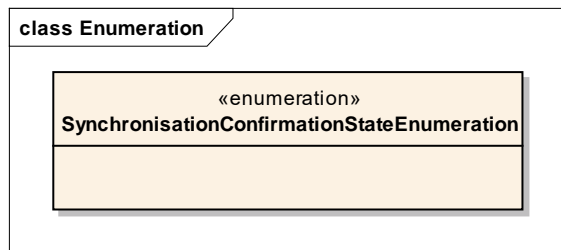

3.2 Code

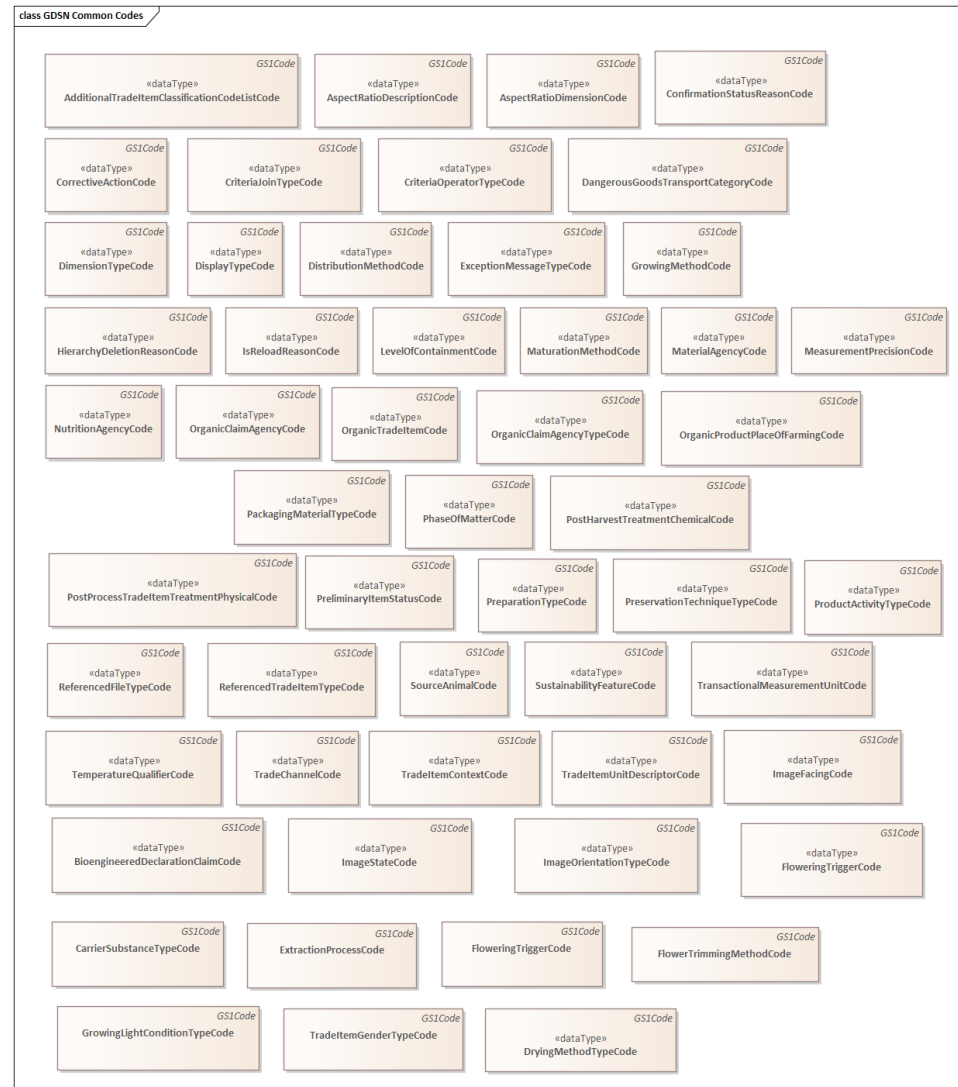

3.3 Compound Data Type

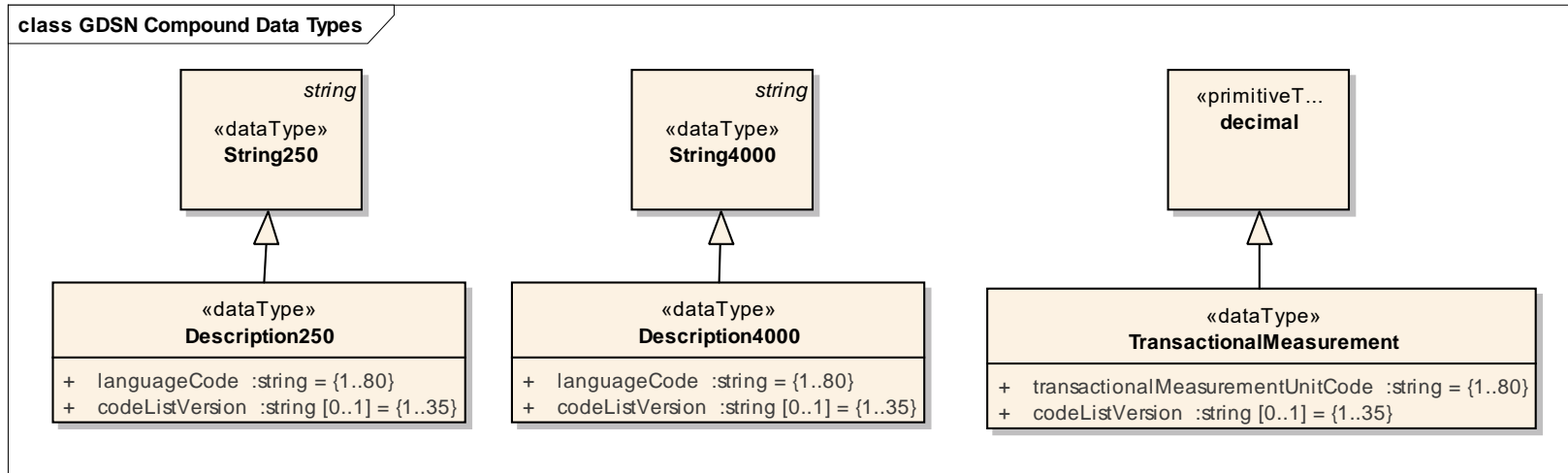

3.3.1 Formatted Description

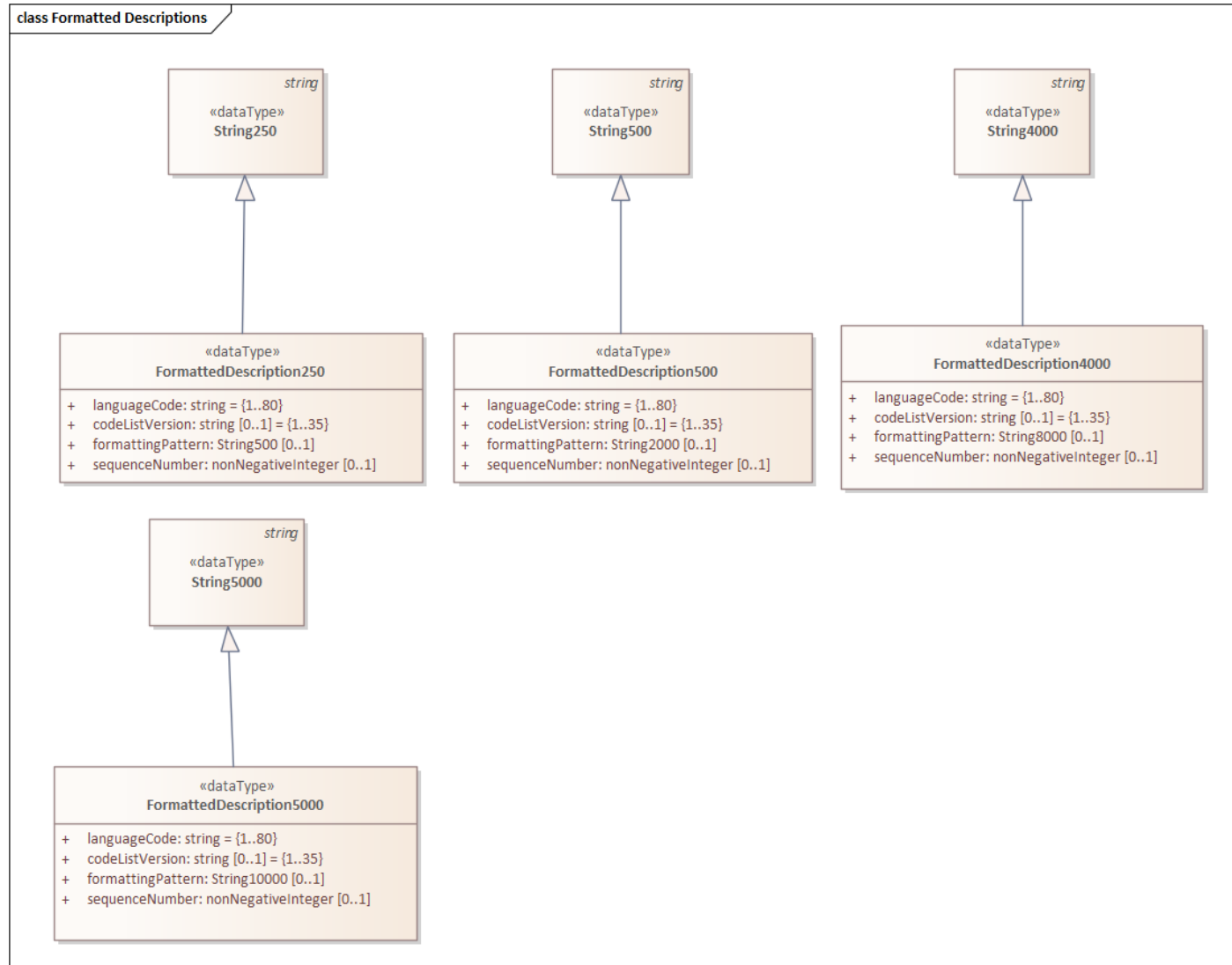

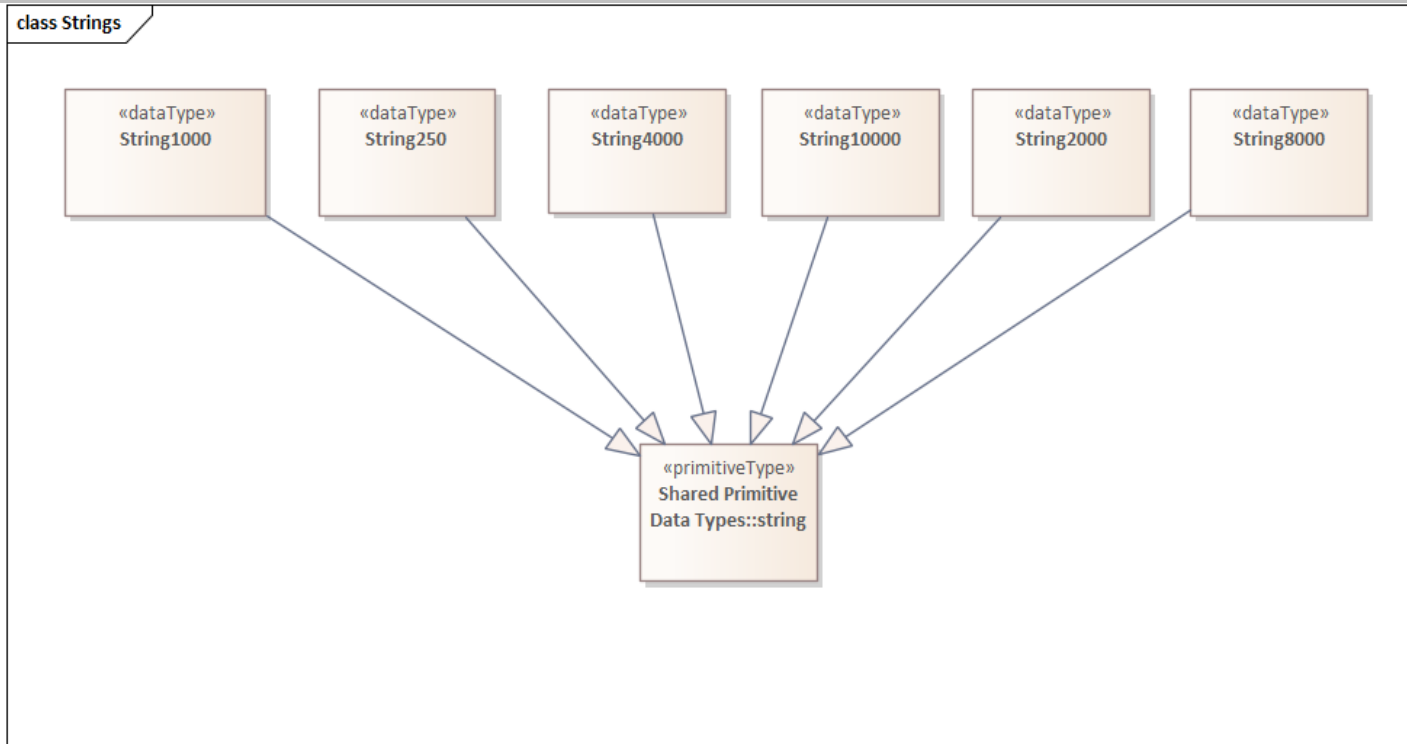

3.3.1 Language Optional Description

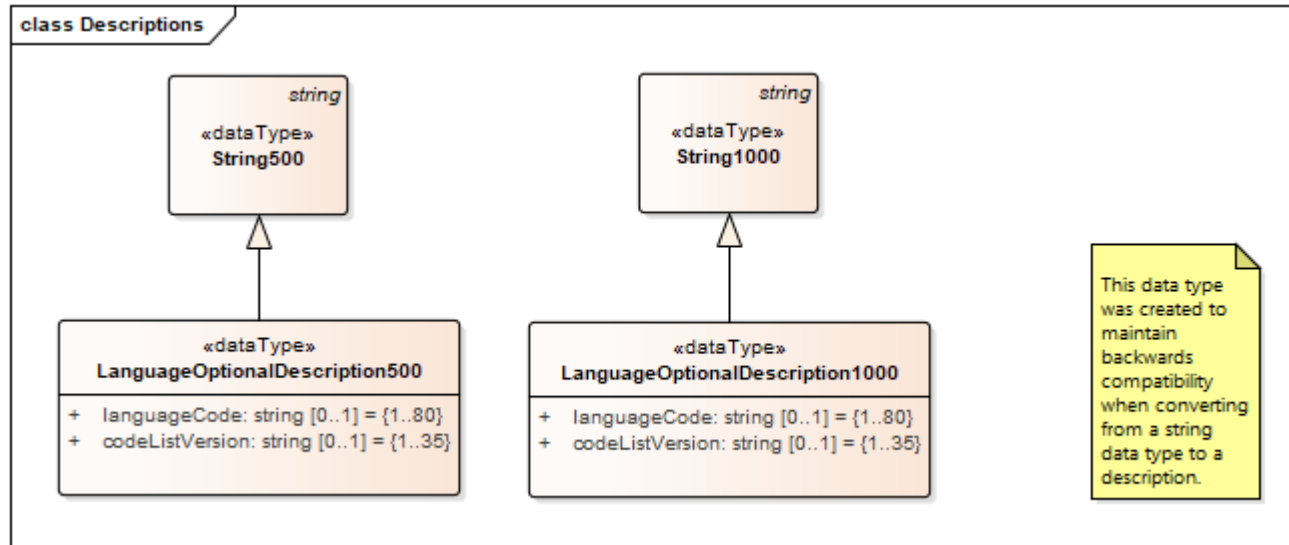

3.4 Additional Trade Item Dimensions

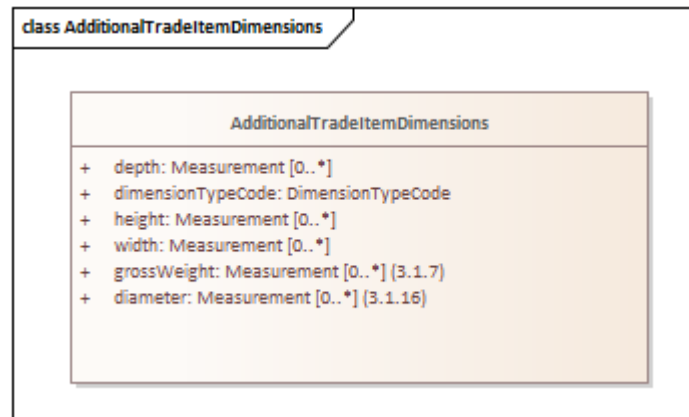

content	attribute / role	datatype /secondary class	multiplcity	definition
AdditionalTradeItemDimensions				The dimensions (depth, height, width) for a trade item in a variety of conditions (in box, out of box, etc.).
Attribute	depth	Measurement	0..*	The depth of the trade item, as measured according to the GS1 Package and Product Measurement Standard. If the trade item is a unit load, include the shipping platform unless it is excluded according to the platformTypeCode chosen.
Attribute	diameter	Measurement	0..*	The measurement of the diameter of the trade item at its largest point. For example, 165 "mmt", value - mmt, diameter. Has to be associated with valid UoM.
Attribute	dimensionTypeCode	DimensionTypeCode	1..1	Depicts certain measurement scenarios (e.g. Retail Display, Out of package) used for measurement.
Attribute	grossWeight	Measurement	0..*	Used to identify the gross weight of the trade item. The gross weight includes all packaging materials of the trade item. Has to be associated with a valid UOM.
Attribute	height	Measurement	0..*	The height of the trade item, as measured according to the GS1 Package and Product Measurement Standard. If the trade item is a unit load, include the shipping platform unless it is excluded according to the platformTypeCode chosen.
Attribute	width	Measurement	0..*	The width of the trade item, as measured according to the GS1 Package and Product Measurement Standard. If the trade item is a unit load, include the shipping platform unless it is excluded according to the platformTypeCode chosen.

3.5 Additive Information

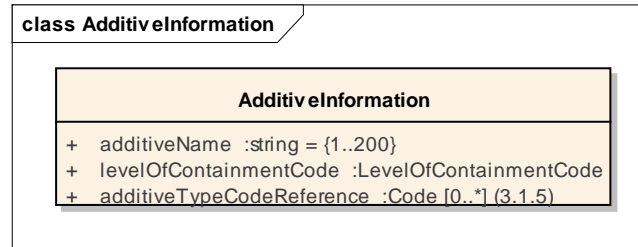

Content	Attribute / Role	Datatype /Secondary class	Multiplicity	Definition
AdditiveInformation				Information on presence or absence of additives or genetic modifications contained in the trade item.
Attribute	additiveName	string	1..1	The name of any additive or genetic modification contained or not contained in the trade item.
Attribute	additiveTypeCodeReference	code	0..*	A code that specifies an additive type for example an EU E-number.
Attribute	levelOfContainmentCode	LevelOfContainmentCode	1..1	Code indicating the level of presence of the additive.

3.6 Aspect Ratio Information

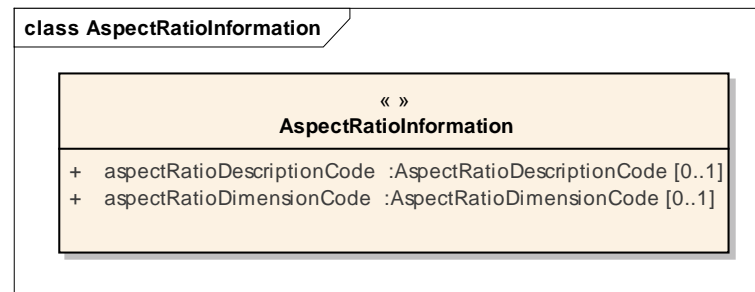

Content	Attribute / Role	Datatype /Secondary class	Multiplicity	Definition
AspectRatioInformation				Logical grouping of attributes related to aspect ratio.
Attribute	aspectRatioDescriptionCode	AspectRatioDescriptionCode	0..1	A code that indicates the aspect ratio description for example ANAMORPHIC.
Attribute	aspectRatioDimensionCode	AspectRatioDimensionCode	0..1	A code that indicates the aspect ratio dimension.

3.7 Catalogue Item Reference

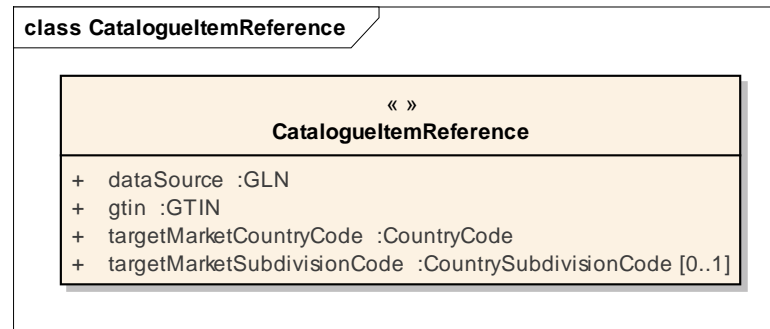

Content	Attribute / Role	Datatype /Secondary class	Multiplicity	Definition
Catalogue Item Reference				A class of information used to identify the key to the trade item information using the data source GLN, the GTIN, and the Target Market within the Global Data Synchronisation Network.
Attribute	dataSource	GLN	1..1	Entity that provides the global data synchronization network with Master Data. The Data Source is officially recognized as the owner of this data. For a given Item or Party, the source of data is responsible for permanent updates of the information under its responsibility.

Content	Attribute / Role	Datatype /Secondary class	Multiplicity	Definition
Attribute	gtin	GTIN	1..1	A particular Global trade item Number, a numerical value used to uniquely identify a trade item. A trade item is any trade item (trade item or service) upon which there is a need to retrieve pre-defined information and that may be planned, priced, ordered, delivered and or invoiced at any point in any supply chain.
Attribute	targetMarketCountryCode	CountryCode	1..1	The code that identifies the target market. The target market is at country level or higher geographical definition and is where a trade-item is intended to be sold.
Attribute	targetMarketCountrySubdivisionCode	CountrySubdivisionCode	0..1	The Code for country sub-division definition used to indicate the geo-political subdivision of the target market (=country).

3.8 Certification Information

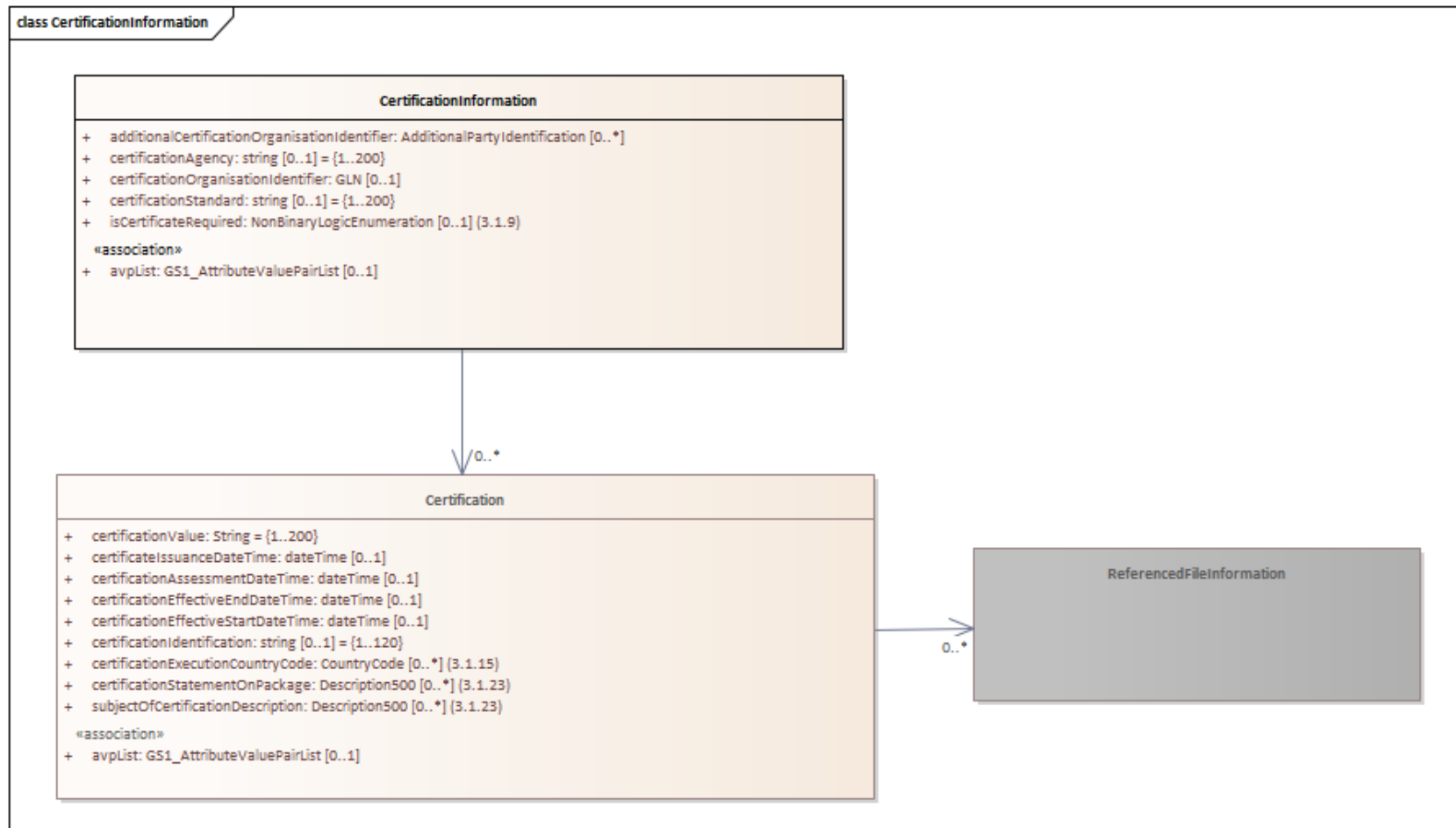

content	attribute / role	datatype /secondary class	multiplicity	definition
Certification				Information on certification to which the trade item complies.
Association		ReferencedFileInformation	0..*	Provides URL and other information on a referenced electronic file.
Association	avpList	GS1_AttributeValuePairList	0..1	The transmission of non-standard data done in a simple, flexible, and easy to use method.
Attribute	certificationIssuanceDateTime	dateTime	0..1	The date and time that a certificate has been issued for a Trade Item.
Attribute	certificationAssessmentDateTime	dateTime	0..1	The date and time that an assessment was performed on a Trade Item that led to a certification.
Attribute	certificationEffectiveEndDateDateTime	dateTime	0..1	The date and time upon which the certification is no longer effective.
Attribute	certificationEffectiveStartDateDateTime	dateTime	0..1	The date and time upon which the certification is effective.
Attribute	certificationExecutionCountryCode	CountryCode	0..*	The country where the certification is performed. Use ISO3166_1 Code
Attribute	certificationIdentification	string	0..1	A reference issued to confirm that something has passed certification.
Attribute	certificationValue	string	1..1	The unique identification (ID) that provides a trade item's certification standard value, official licensing number or identification which proves that a product/process has passed the certification procedure.
Attribute	certificationStatementOnPackage	Description500	0..*	The statement provided from the certification agency that must be displayed on the packaging according to the certification agreement.
Attribute	subjectOfCertificationDescription	Description500	0..*	The description that provides more information about the type of certification, e.g. the type of product, model, etc. as stated on the certificate.
CertificationInformation				Information on certification standards to which the trade item, or the process by which it is manufactured, sourced or supplied complies.
Association		Certification	0..*	Information on certification to which the trade item complies.
Association	avpList	GS1_AttributeValuePairList	0..1	The transmission of non-standard data done in a simple, flexible, and easy to use method.

content	attribute / role	datatype /secondary class	multiplicity	definition
Attribute	additionalCertificationOrganisationIdentifier	AdditionalPartyIdentification	0..*	Additional identification of the organization that issued the certificate number confirming that the Trade Item has gone through certification.
Attribute	certificationAgency	String	0..1	Name of the organization issuing the certification standard or other requirement being met. Free text field. Example: European Union.
Attribute	certificationOrganisationIdentifier	GLN	0..1	The identification of the organization that issued the certificate number confirming that the Trade Item has gone through certification.
Attribute	certificationStandard	string	0..1	The name of the certification standard or the type of certification, e.g. product, process, company, packaging or conformity.
Attribute	isCertificateRequired	NonBinaryLogicEnumeration	0..1	Determines whether a specific certificate is required by regulation or legal property.

3.9 Country

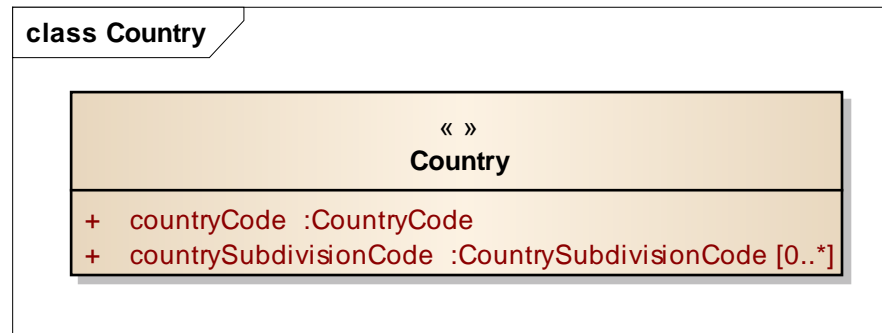

Content	Attribute / Role	Datatype /Secondary class	Multiplicity	Definition
Country				Information on a country and any included subdivision.
Attribute	countryCode	countryCode	1..1	Code specifying a country.

Content	Attribute / Role	Datatype /Secondary class	Multiplicity	Definition
Attribute	countrySubdivisionCode	countrySubdivisionCode	0..*	Code specifying a country subdivision.

3.10 External Code Value Information

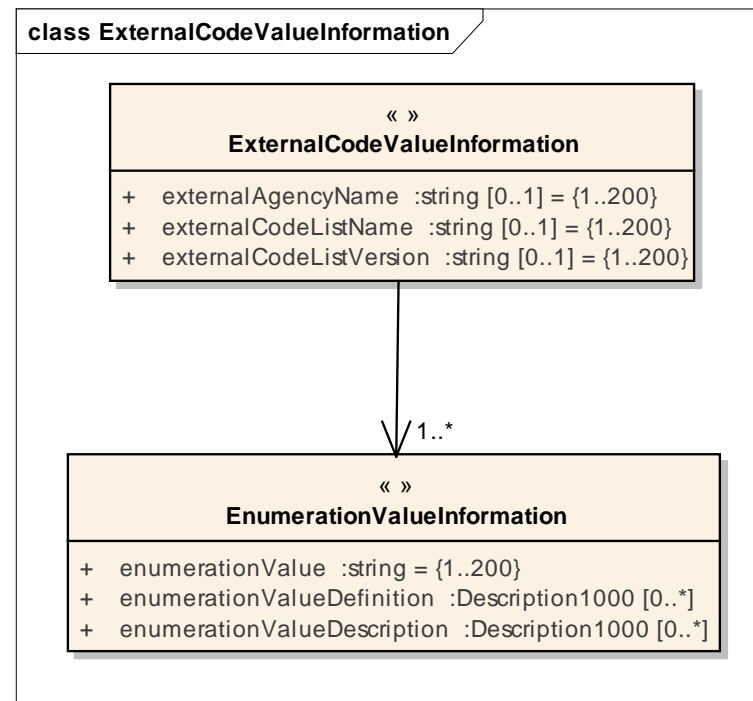

Content	Attribute / Role	Datatype /Secondary class	Multiplicity	Definition
Enumeration Value Information				A code list value that is maintained by an agency external to GS1.

Content	Attribute / Role	Datatype /Secondary class	Multiplicity	Definition
Attribute	enumerationValue	string	1..1	Code List Value maintained by an external code list agency.
Attribute	enumerationValueDefinition	Description1000	0..*	Definition of the code list value maintained by an external code list agency
Attribute	enumerationValueDescription	Description1000	0..*	Description of the value in a code list value maintained by an external code list agency. This is primarily used when code list values are sequential numbers.
ExternalCode ValueInformation				Class allowing for multiple code list values that are maintained by an agency external to GS1.
Association		EnumerationValueInformation	1..*	A code value for an external code list.
Attribute	externalAgencyName	string	0..1	The name of the agency that manages a code list external to GS1.
Attribute	externalCodeListName	string	0..1	The name of the code list maintained by an agency external to GS1.
Attribute	externalCodeListVersion	string	0..1	The version of the code list maintained by an agency external to GS1.

3.11 Farming and Processing Information

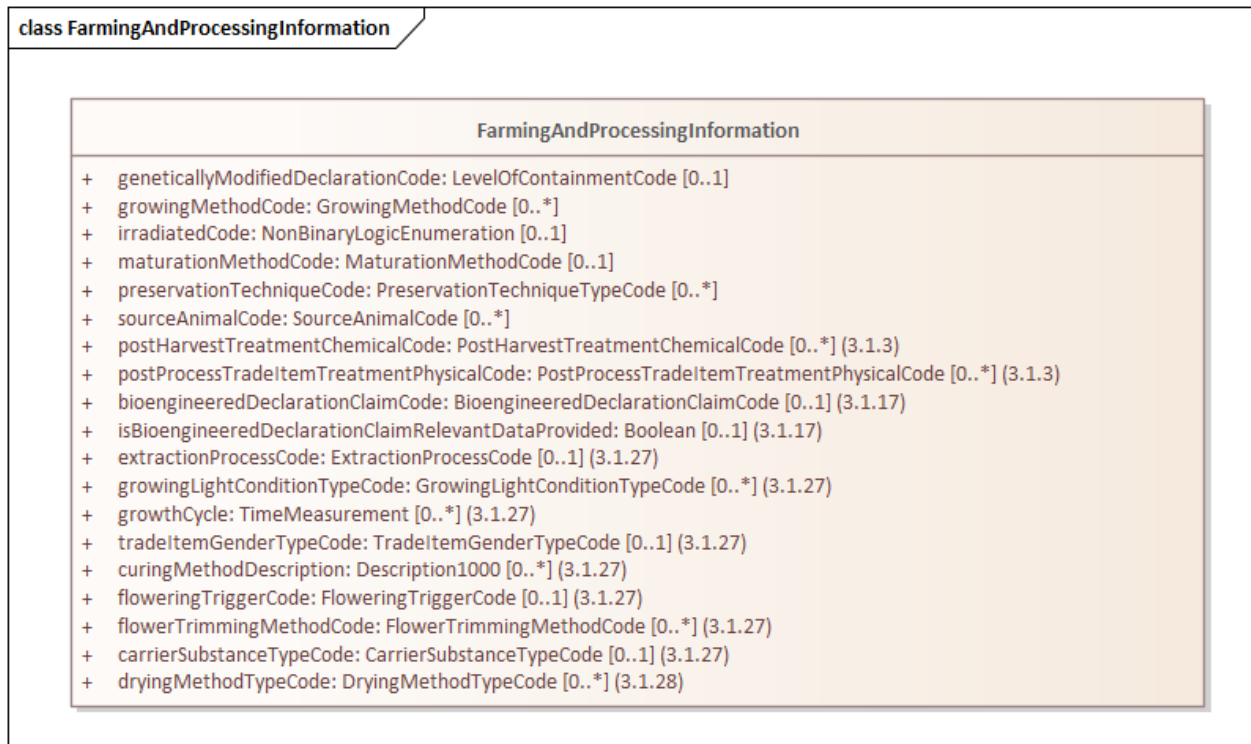

content	attribute / role	datatype /secondary class	multipl icity	definition
FarmingProcessin g			0..1	Details on any methods and techniques used by a manufacturer or supplier to the trade item, ingredients or raw materials.

content	attribute / role	datatype /secondary class	multiplicity	definition
Attribute	bioengineeredDeclarationClaimCode	BioengineeredDeclarationClaimCode	0..1	This code indicates a product that contains detectable genetically modified material for which the modification could not otherwise be obtained through conventional breeding or found in nature. This code may also be used to indicate a product manufactured using ingredients derived through bioengineering that have undergone processes that remove modified genetic material such that it cannot be detected using common testing methods. Excludes incidental additives.
Attribute	carrierSubstanceTypeCode	CarrierSubstanceTypeCode	0..1	The code specifying the underlying substance (e.g., oils) that is used to absorb compounds to make them more bioavailable (i.e., easily absorbed by the body).
Attribute	curingMethodDescription	Description1000	0..*	The description of the process that involves aging and drying harvested plant material, meat or fish.
Attribute	dryingMethodTypeCode	DryingMethodTypeCode	0..*	The code indicating the method used in the drying process of a product.
Attribute	extractionProcessCode	ExtractionProcessCode	0..1	The code indicating the process to remove oil or resin from plant material to make a concentrate product.
Attribute	floweringTriggerCode	FloweringTriggerCode	0..1	The code indicating the environmental factors that cause a plant to start to flower (also known as the flowering trigger point).
Attribute	flowerTrimmingMethodCode	FlowerTrimmingMethodCode	0..*	The code indicating the method used for flower trimming and removing plant foliage during harvest.
Attribute	growthCycle	TimeMeasurement	0..*	The estimated time a seed takes from germination to vegetation.
Attribute	growingLightConditionTypeCode	GrowingLightConditionTypeCode	0..*	The code indicating the light conditions where plants are grown.
Attribute	tradeItemGenderTypeCode	TradeItemGenderTypeCode	0..1	The code that indicates the gender of the animal, plant or seed that is being sold.
Attribute	geneticallyModifiedDeclarationCode	LevelOfContainmentCode	0..1	A statement of the presence or absence of genetically modified protein or DNA.
Attribute	growingMethodCode	growingMethodCode	0..*	The code indicating how the product has been grown, cultivated, reared and/or raised.

content	attribute / role	datatype /secondary class	multiplicity	definition
Attribute	irradiatedCode	NonBinaryLogicEnumeration	0..1	Indicates if radiation has been applied.
Attribute	isBioengineeredDeclarationClaimRelevantDataProvided	Boolean	0..1	All Bioengineered Declaration Claim Information is populated for those values which are relevant or required to be populated on the product label or label equivalent. values not populated are not relevant or not required to be populated on the product label by local regulations.
Attribute	maturationMethodCode	MaturationMethodCode	0..1	The method of maturity for the item or ingredient for example tree ripened or jet fresh.
Attribute	preservationTechniqueCode	PreservationTechniqueTypeCode	0..*	Code value indicating the preservation technique used to preserve the product from deterioration.
Attribute	sourceAnimalCode	sourceAnimalCode	0..*	The source of raw material used to produce the food product for example a goat for milk.
Attribute	postHarvestTreatmentChemicalCode	PostHarvestTreatmentChemicalCode	0..*	Specifies if the fruit or vegetable has been treated or not post harvesting with a chemical or wax.
Attribute	postProcessTradeItemTreatmentPhysicalCode	PostProcessTradeItemTreatmentPhysicalCode	0..*	Produce has gone some physical process whether altered or other physical processes after harvesting.

3.12 GS1 Attribute Value Pair List

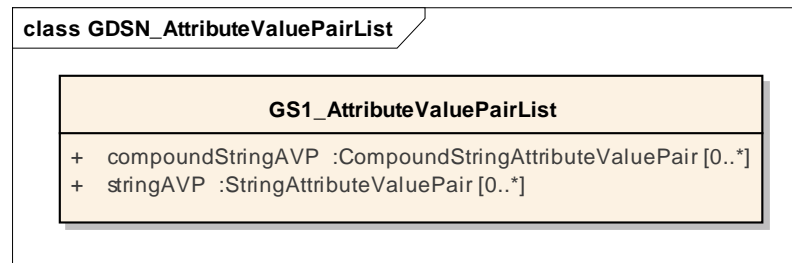

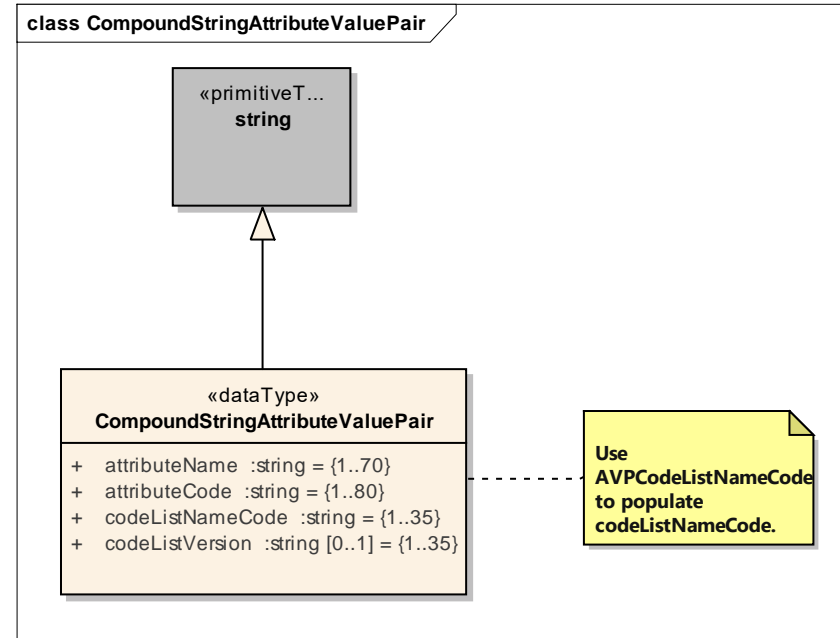

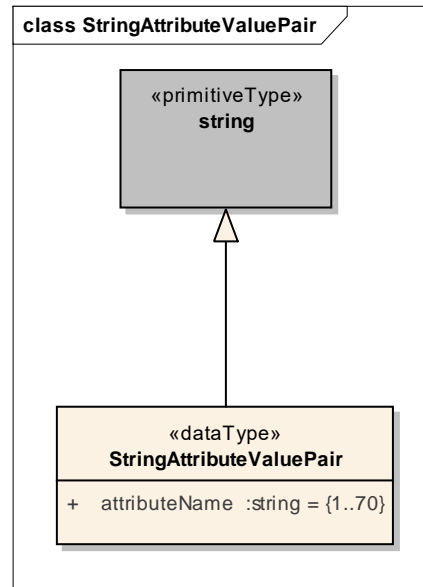

Content	Attribute / Role	Datatype /Secondary class	Multiplicity	Definition
GS1_AttributeValuePairList				The transmission of non-standard data done in a simple, flexible, and easy to use method.
	compoundStringAVP	CompoundStringAttributeValuePair	0..*	An attribute value pair that allows for a string and an associated qualifier (e.g. Unit Of Measure).
	stringAVP	StringAttributeValuePair	0..*	An attribute value pair that allows for string values.
CompoundStringAttributeValuePair				A data type that allows for temporary attributes along with associated qualifiers (e.g. unit of measure, currency code) introduced between minor versions.
	attributeName	String	1..1	The name of the temporary attribute being passed as an attribute value pair.
	attributeCode	String	1..1	The value associated with the codeListName for example MLT for MEASUREMENT_CODE.

Content	Attribute / Role	Datatype /Secondary class	Multiplicity	Definition
	codeListNameCode	String	1..1	The code list qualifying the temporary attribute for example MEASUREMENT_CODE. Use AVPCoDeListNameCode to populate codeListNameCode.
	codeListVersion	String	0..1	The version of the code list qualifying the temporary attribute.
StringAttributeValuePair				The transmission of non-standard data done in a simple, flexible, and easy to use method for simple text fields (no language).
	attributeName		1..1	The name of the temporary attribute being passed as an attribute value pair.

3.13 GDSN Trade Item Classification Attribute

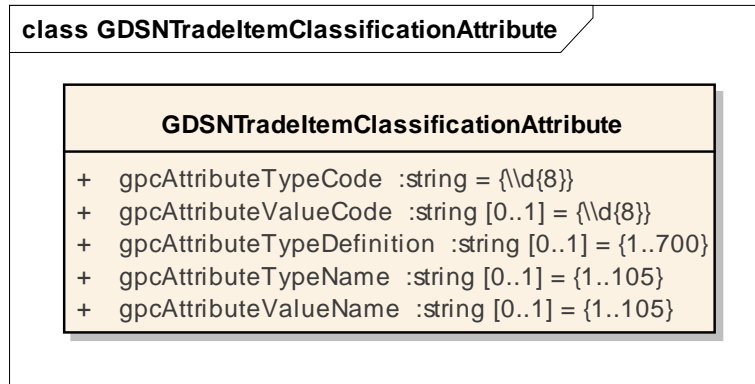

Content	Attribute / Role	Datatype /Secondary class	Multiplicity	Definition
GDSNTradeItemClassificationAttribute				Information on the type and value of a Global Product Classification (GPC) attribute.
Attribute	gpcAttributeTypeCode	string	1..1	Code specifying the type of the Global Product Classification (GPC) attribute, for example 2000081 - Grape Variety.
Attribute	gpcAttributeValueCode	string	0..1	The GS1 provided code which identifies the Global Product Classification Attribute Value.
Attribute	gpcAttributeTypeDefinition	string	0..1	The GS1 provided definition of the Global Product Classification Attribute Code.
Attribute	gpcAttributeTypeName	string	0..1	The GS1 provided text equivalent of the Global Product Classification Attribute Code.
Attribute	gpcAttributeValueName	string	0..1	The GS1 provided text equivalent of the Global Product Classification Attribute Value Code.

3.14 Hazardous Information Header

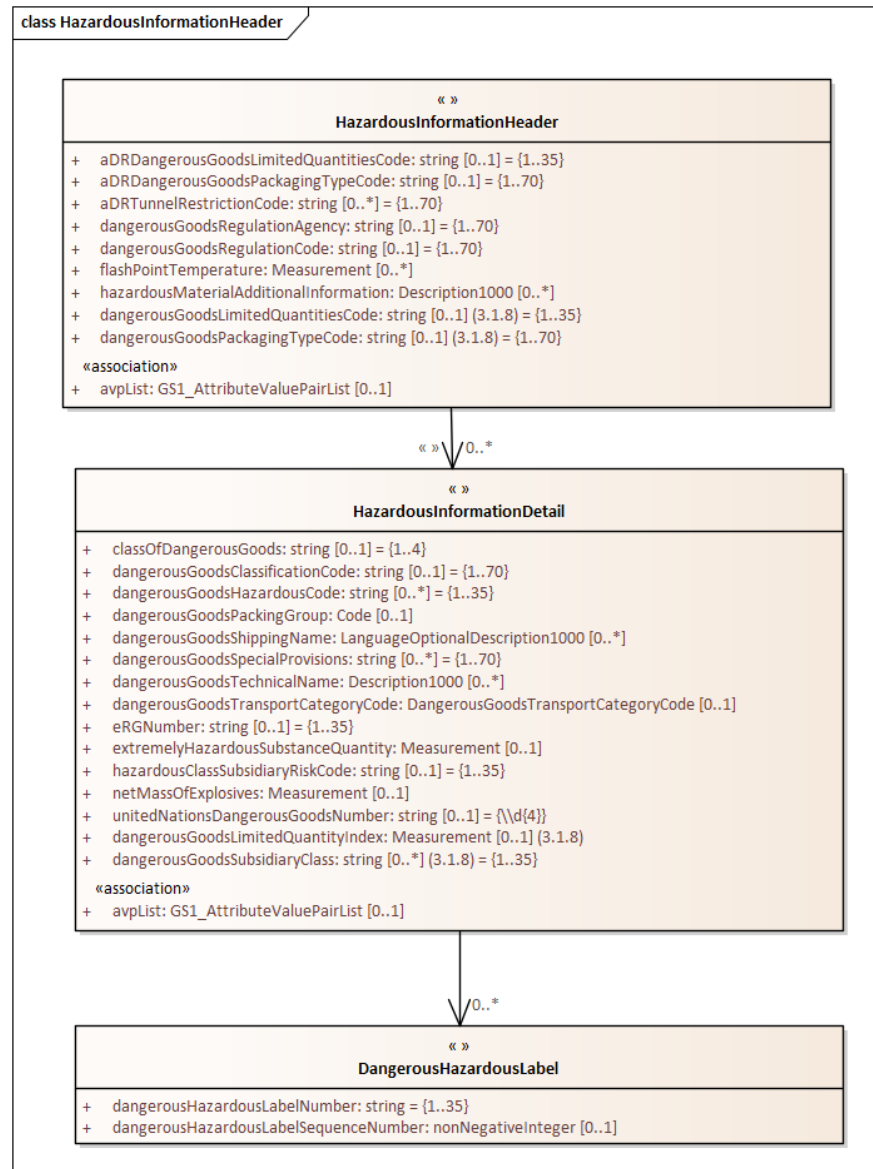

Content	Attribute / Role	Datatype /Secondary class	Multiplicity	Definition
DangerousHazardousLabel				Information on visible labels on packaging indicating specific risks and required precautions associated with a dangerous/hazardous good.
Attribute	dangerousHazardousLabelNumber	string	1..1	A visible number indicating the specific risk and thus the required precautions associated with a dangerous or hazardous good for example, the indication of the hazardous label number according to chapter 3.2, table A of the ADR.
Attribute	dangerousHazardousLabelSequenceNumber	nonNegativeInteger	0..1	A sequence number indicating the primacy of one dangerous/hazardous label number over another. For example, a value of 1 would indicate that the associated hazard label number is the primary, 2 = secondary, etc.
HazardousInformationDetail				Details on hazardous information for a trade item.
Association	avpList	GS1_AttributeValuePairList	0..1	The transmission of non-standard data done in a simple, flexible, and easy to use method.
Association		DangerousHazardousLabel	0..*	Information on visible labels on packaging indicating specific risks and required precautions associated with a dangerous good.
Attribute	classOfDangerousGoods	string	0..1	The dangerous goods classification of the trade item. Dangerous classes explain in general terms the hazardous nature and properties of the goods and serves to classify them together in terms of their most significant risk.
Attribute	dangerousGoodsClassificationCode	string	0..1	A classification code of the trade item (dangerous goods) for transport by road and rail for example ADR/RID. It indicates the dangerous characteristics respectively the subsections of the trade item within a given classification.
Attribute	dangerousGoodsHazardousCode	string	0..*	Dangerous goods hazard ID number, which must be applied to the vehicle, when transporting this trade item (dangerous good) by road or rail, to inform the police, the fire brigade and others in case of an accident about the kind of danger caused by the cargo.

Content	Attribute / Role	Datatype /Secondary class	Multiplicity	Definition
Attribute	dangerousGoodsLimitedQuantityIndex	Measurement	0..1	The maximum quantity of dangerous goods that may be transported as a "limited quantity". This is the quantity per inner means of containment of each case. For example, 1234.1234 KGM.
Attribute	dangerousGoodsPackagingGroup	Code	0..1	Identifies the degree of risk these dangerous goods present during transport according to IATA/IMDG/ADR/RID regulations.
Attribute	dangerousGoodsShippingName	LanguageOptionalDescription1000	0..*	Shipping name of the trade item (dangerous goods). The recognized agencies (see dangerousGoodsRegulationsCodes), in their regulations, provide a list of all acceptable proper shipping names.
Attribute	dangerousGoodsSpecialProvisions	string	0..*	A numeric code of special regulations to be met regarding a Dangerous Goods Classification Regulation. For example ADR 2005 provides additional information for identifying the substances or items (s. 3.2.1 ADR 2005). Special provisions can include transport restrictions, exemptions from regulation, explanations on the classifying of certain forms of the dangerous goods in question as well as additional marking and labelling requirements.
Attribute	dangerousGoodsSubsidiaryClass	string	0..*	Local dangerous goods regulations may allow for a subsidiary or secondary dangerous goods class number to be associated with the first or primary dangerous goods class number. Depending on local regulations, a subsidiary class number may be shown in parentheses immediately after the first or primary dangerous goods class number.
Attribute	dangerousGoodsTechnicalName	Description1000	0..*	Provides the dangerous goods technical information.
Attribute	dangerousGoodsTransportCategoryCode	DangerousGoodsTransportCategoryCode	0..1	Trade items classified as dangerous goods are divided into transport categories for the purpose of calculating what quantity of dangerous goods is allowed to be transported on the same transport unit under specific exemption rules.

Content	Attribute / Role	Datatype /Secondary class	Multiplicity	Definition
Attribute	eRGNumber	string	0..1	<p>A number used to find the correct section within the Emergency Response Guide. The ERG is a guide to first responders to quickly identify the material involved in an incident for example a fire or spill. It is derivative from the UN Number.</p> <p>Note: The ERG number is only required in the United States.</p>
Attribute	extremelyHazardousSubstanceQuantity	Measurement	0..1	<p>The quantity of substance that is considered to be extremely hazardous under a regulatory threshold. For SARA, this is the threshold planning quantity in pounds per 40 Code of Federal Regulations (CFR) under section 302 of SARA Title 3.</p>
Attribute	hazardousClassSubsidiaryRiskCode	string	0..1	<p>A code determining a Secondary or Tertiary hazard related to a hazardous class for example corrosive.</p>
Attribute	netMassOfExplosives	Measurement	0..1	<p>The measurement of the net explosive mass of the trade item (dangerous goods) for transport by road and rail according to a dangerous goods classification regulation.</p>
Attribute	unitedNationsDangerousGoodsNumber	string	0..1	<p>The four-digit number assigned by the United Nations Committee of Experts on the Transport of Dangerous Goods to classify a substance or a particular groups of substances. Abbreviation: UNDG Number.</p> <p>Recommend to use codes listed in the latest edition of the UN Recommendations on the Transport of Dangerous Goods.</p>
HazardousInformationHeader				<p>Hazardous Information for a trade item.</p>
Association		HazardousInformationDetail	0..*	<p>Hazardous detail for a trade item.</p>
Association	avpList	GS1_AttributeValuePairList	0..1	<p>The transmission of non-standard data done in a simple, flexible, and easy to use method.</p>

Content	Attribute / Role	Datatype /Secondary class	Multiplicity	Definition
Attribute	aDRDangerousGoodsLimitedQuantitiesCode	string	0..1	A code defined by RID (Regulations concerning the International Carriage of Dangerous Goods by Rail) and ADR (Accord Européen Relatif au Transport International des Marchandises Dangereuses par Route) specifying whether a dangerous good can be packaged in small quantities providing they are packaged and labelled in accordance with certain requirements. Note: this attribute is being deprecated for release 3.1.8. Use dangerousGoodsLimitedQuantitiesCode.
Attribute	aDRDangerousGoodsPackagingTypeCode	string	0..1	Approved packaging for ADR regulation. ADR regulations include packaging regulations, packaging types and requirements and testing regulations concerning packaging. Dangerous goods should be packed in a way that they remain in the package during transport. If a package or container meant for transportation of dangerous goods is damaged, it is forbidden to carry out the transport. Note: this attribute is being deprecated for release 3.1.8. Use dangerousGoodsPackagingTypeCode.
Attribute	aDR TunnelRestriction Code	string	0..*	The ADR Tunnel Restriction Code is a code defined in ADR Chapter 8.6, which categorizes road tunnels into categories A to E. Adequate traffic signs regulate the transit of vehicles with dangerous goods. The tunnel restriction code (e.g. E) has to be stated within the transport papers. Trading Partners should look to the specific ADR documentation for current applicable code list values.
Attribute	dangerousGoodsLimitedQuantitiesCode	string	0..1	A code defined by by an agency specifying whether a dangerous good can be packaged in small quantities providing they are packaged and labelled in accordance with certain requirements. Note: for 3.1.8, this attribute replaces aDRDangerousGoodsLimitedQuantityCode.
Attribute	dangerousGoodsPackagingTypeCode	string	0..1	Approved packaging for regulation. The regulations include packaging regulations, packaging types and requirements and testing regulations concerning packaging. Dangerous goods should be packed in a way that they remain in the package during transport. If a package or container meant for transportation of dangerous goods is damaged, it is forbidden to carry out the transport. Note:For Release 3.1.8, this replaces aDRDangerousGoodsPackagingTypeCode.
Attribute	dangerousGoodsRegulationAgency	string	0..1	An indication of the agency responsible for a classification system(s) of dangerous goods.

Content	Attribute / Role	Datatype /Secondary class	Multiplicity	Definition
Attribute	dangerousGoodsRegulationCode	string	0..1	An indication of the classification system(s) of dangerous goods and/or the Agency(ies) responsible for it.
Attribute	flashPointTemperature	Measurement	0..*	The minimum temperature at which a liquid gives off a vapour within a vessel in sufficient concentration to form an ignitable mixture with air near the surface of a liquid.
Attribute	hazardousMaterialAdditionalInformation	Description1000	0..*	Any regulatory information required that is not specifically identified by another field.

3.15 Incoterm Information

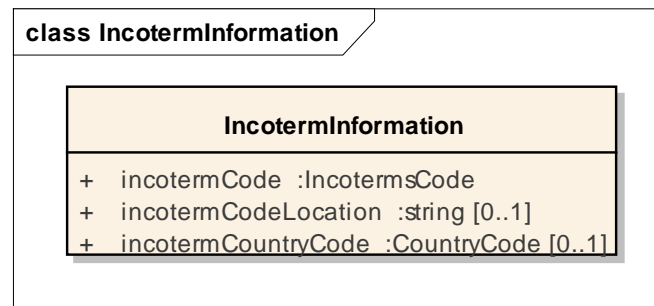

Content	Attribute / Role	Datatype /Secondary class	Multiplicity	Definition
IncotermInformation				Incoterms is an abbreviation for International Commercial Terms. The International Chamber of Commerce created and manages the Incoterms and their definitions. There are 13 available for use in the buyer-seller contractual agreements.
Attribute	incotermCode	IncotermsCode	1..1	Incoterms is an abbreviation for International Commercial Terms. The International Chamber of Commerce created and manages the Incoterms and their definitions. There are 13 available for use in the buyer-seller contractual agreements.
Attribute	incotermCodeLocation	string	0..1	A description of the location required by an Incoterm.
Attribute	incotermCountryCode	CountryCode	0..1	The location country code where the incoterm event (e.g. DDP Delivered Duty Paid) has occurred.

3.16 Organic Information

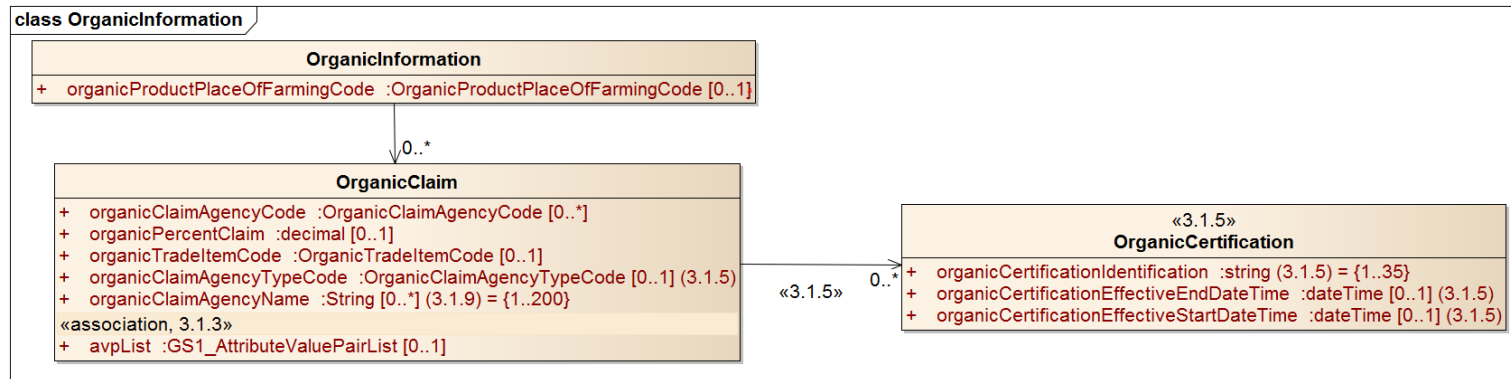

content	attribute / role	datatype /secondary class	multiplcity	definition
OrganicCertification				A certification in relation to a specific organic claim.
Attribute	organicCertificationIdentification	string	1..1	A number issued to confirm that something has passed organic certification.
Attribute	organicCertificationEffectiveEndDateTime	dateTime	0..1	The date and time upon which the organic certification is no longer effective.
Attribute	organicCertificationEffectiveStartDateTime	dateTime	0..1	The date and time upon which the organic certification is effective.
OrganicClaim				Any claim to indicate the organic status of a trade item or of one or more of its components.
Attribute	organicClaimAgencyCode	OrganicClaimAgencyCode	0..*	A governing body that creates and maintains standards related to organic products.
Attribute	organicClaimAgencyTypeCode	OrganicClaimAgencyTypeCode	0..1	A code depicting whether an organic agency manages organic standards or issues certifications.
Attribute	organicPercentClaim	decimal	0..1	The percent of actual organic materials per weight of the trade item. This is usually claimed on the product.
Attribute	organicTradeItemCode	OrganicTradeItemCode	0..1	Used to indicate the organic status of a trade item or of one or more of its components.
Attribute	organicClaimAgencyName	String	0..*	Organization that issued the organic certificate number confirming that the Trade Item has gone through certification.

content	attribute / role	datatype /secondary class	multiplcity	definition
Association		OrganicCertificatio n	0..*	A certification in relation to an organic claim.
Association	avplList	GS1_AttributeValu ePairList	0..1	The transmission of non-standard data done in a simple, flexible, and easy to use method.
OrganicInformatio n				Information on the organic nature of trade items.
Association		OrganicClaim	0..*	Any claim to indicate the organic status of a trade item or of one or more of its components.
Attribute	organicProductPlaceO fFarmingCode	OrganicProductPlac eOfFarmingCode	0..1	<p>Indication of the place where the agricultural raw materials of which the product is composed have been farmed, acc. To Council Regulation (EC) No 834/2007. It applies only to the trade item, not ingredient by ingredient. Where the Community logo is used, an indication of the place where the agricultural raw materials of which the product is composed have been farmed, shall also appear in the same visual field as the logo and shall take one of the code list forms, as appropriate. For EU or NON-EU indication, small quantities by weight of ingredients may be disregarded provided, that the total quantity of the disregarded ingredients does not exceed 2 % of the total quantity by weight of raw materials of agricultural origin. This Regulation shall apply to the following products originating from agriculture, including aquaculture, where such products are placed on the market or are intended to be placed on the market:</p> <ul style="list-style-type: none"> a) Live or unprocessed agricultural products; b) Processed agricultural products for use as food; c) Feed; d) Vegetative propagating material and seeds for cultivation. <p>The products of hunting and fishing of wild animals shall not be considered as organic production.</p> <p>This Regulation shall also apply to yeasts used as food or feed.</p>

3.17 Party In Role

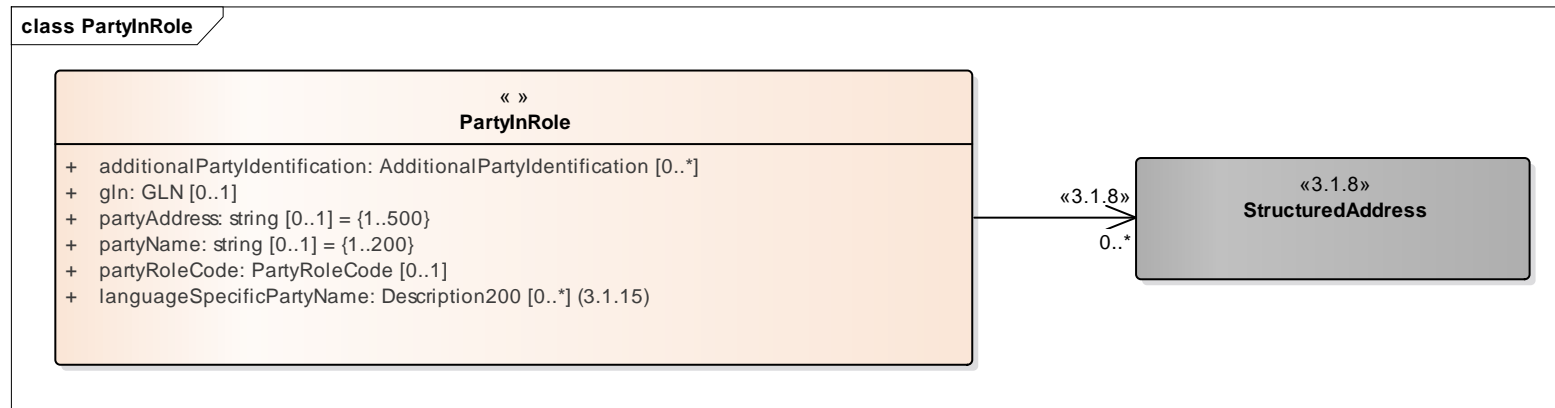

Content	Attribute / Role	Datatype /Secondary class	Multiplicity	Definition
PartyInRole				The identification of a party, by GLN, in a specific party role.
Attribute	additionalPartyIdentification	AdditionalPartyIdentification	0..*	Identification of a party by use of a code other than the Global Location Number.
Attribute	gln	GLN	0..1	The Global Location Number (GLN) is a structured Identification of a physical location, legal or functional entity within an enterprise. The GLN is the primary party identifier. Each party identified in the trading relationship must have a primary party Identification.
Attribute	languageSpecificPartyName	Description200	0..*	The recognisable party name used by a supplier to uniquely identify the name of the party in a different language than the primary party name (partyName).
Attribute	partyAddress	String	0..1	The address associated with the party. This could be the full company address.
Attribute	partyName	string	0..1	The name of the party expressed in text.
Attribute	partyRoleCode	PartyRoleCode	0..1	A code that identifies the role of a party in a business transaction.
Association		StructuredAddress	0..*	An address in a structured format for a specific party.

3.18 Place Of Product Activity

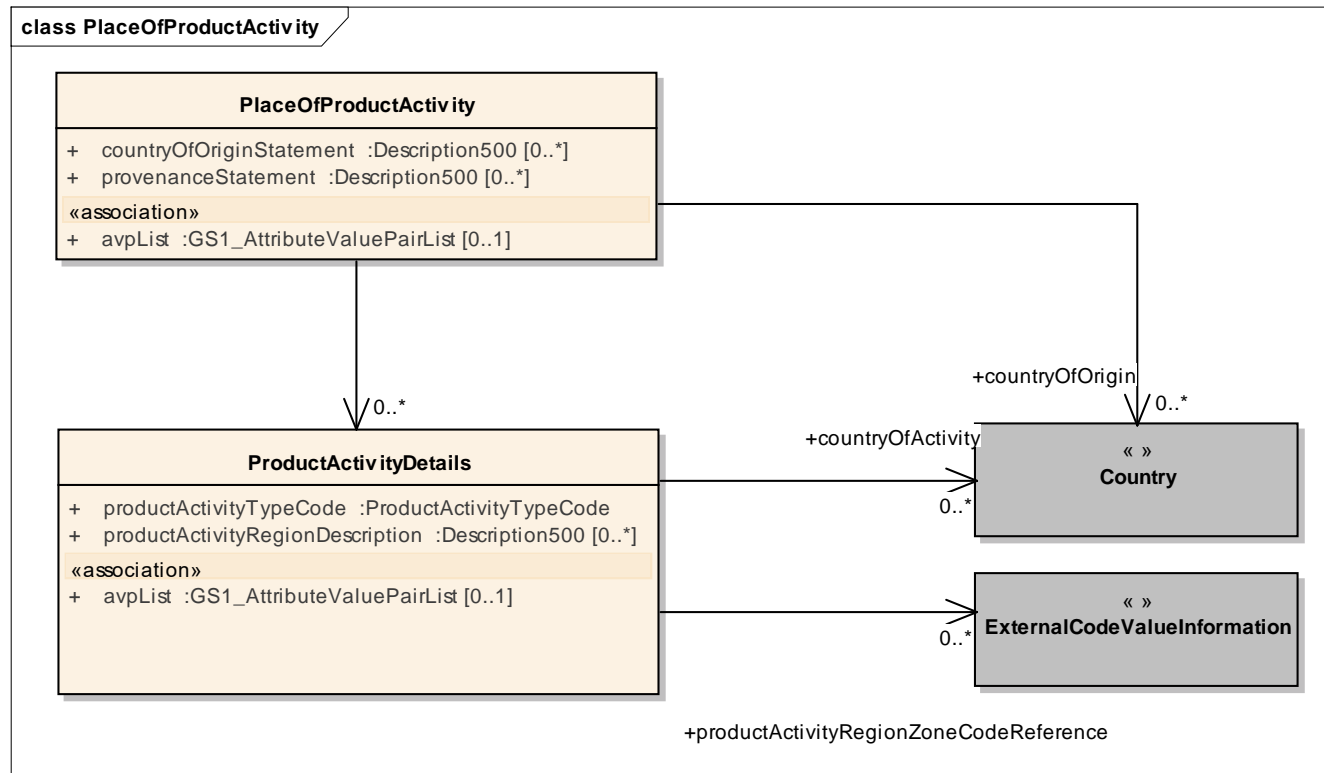

content	attribute / role	datatype / secondary class	multi plicity	definition
PlaceOfProduct Activity				Information on the activity (e.g. bottling) taken place for a trade item as well as the associated geographic area.
Attribute	countryOfOriginStatement	Description500	0..*	A description of the country the item may have originated from or has been processed for example "Made in Germany".
Attribute	provenanceStatement	Description500	0..*	The place a trade item originates from. This is to be specifically used to enable things such as cities, mountain ranges, regions that do not comply with ISO standards. It may also include country(ies). Examples: Made in Thüringen Mountains, Made in Paris, From the Napa Valley, Made in Greece.

content	attribute / role	datatype / secondary class	multiplicity	definition
Association	avpList	GS1_AttributeValuePairList	0..1	The transmission of non-standard data done in a simple, flexible, and easy to use method.
Association	countryOfOrigin	Country	0..*	The ISO code of the country, and optionally subdivision, the item may have originated from or has been processed. Example : 276 (for Germany).
Association		productActivityDetails	0..*	Details on the activity (e.g. bottling) taken place for a trade item as well as the associated geographic area.
ProductActivityDetails				Details on the activity (e.g. bottling) taken place for a trade item as well as the associated geographic area.
Attribute	productActivityTypeCode	ProductActivityTypeCode	1..1	A code depicting the type of activity being performed on a trade item for example ASSEMBLY, BOTTLING, LAST_PROCESSING.
Attribute	productActivityRegionDescription	Description500	0..*	The region in which a processing or other activity has been performed for example bottling, farming, last processing.
Association	countryOfActivity	Country	0..*	The geographic area where an activity has taken place.
Association	productActivityRegionZoneCodeReference	ExternalCodeValueInformation	0..*	An external code value (code list managed outside of GS1) that depicts a specific zone or region for example an FAO Catch Zone. Use GS1 Code List CatchAreaCode when productActivityType equals CATCH_ZONE.
Association	avpList	GS1_AttributeValuePairList	0..1	The transmission of non-standard data done in a simple, flexible, and easy to use method.

3.19 Referenced File Information

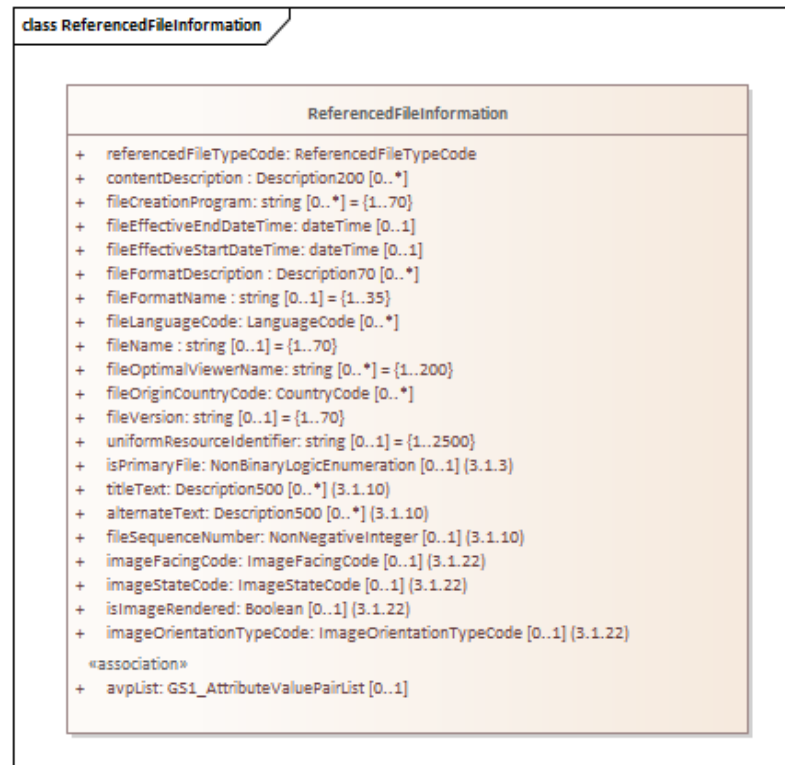

Content	Attribute / Role	Datatype /Secondary class	Multiplicity	Definition
ReferencedFileInformation				Provides URL and other information on a referenced electronic file.
Attribute	referencedFileTypeCode	ReferencedFileTypeCode	1..1	The type of file that is being referenced for example Safety Data Sheet or Product Image.
Attribute	contentDescription	Description200	0..*	Free form description of the content of the file

Content	Attribute / Role	Datatype /Secondary class	Multiplicity	Definition
Attribute	fileCreationProgram	string	0..*	The program used in the creation of the digital asset.
Attribute	fileEffectiveEndDateTime	dateTime	0..1	The date upon which the target of this external link ceases to be effective for use.
Attribute	fileEffectiveStartDateTime	dateTime	0..1	The date upon which the target of this external link begins to be effective for use.
Attribute	fileFormatDescription	Description70	0..*	Free form description of the format of the file.
Attribute	fileFormatName	string	0..1	The name of the file format. Examples: PDF; JPEG; BMP
Attribute	fileLanguageCode	LanguageCode	0..*	The specified language to which the digital asset is targeted.
Attribute	fileName	string	0..1	The name of the file that contains the external information.
Attribute	fileOptimalViewerName	string	0..*	The software to which this file was targeted.
Attribute	fileOriginCountryCode	CountryCode	0..*	The country where the digital asset originated.
Attribute	fileVersion	string	0..1	A description of the terms used by the manufacturer to denote the version of the digital asset.
Attribute	uniformResourceIdentifier	string	0..1	Simple text string that refers to a resource on the internet, URLs may refer to documents, resources, people, etc.
Attribute	imageFacingCode	ImageFacingCode	0..1	The code that defines which face of the item is depicted in the image. (More information on these codes can be found in the GS1 Product Image Specification Standard for the naming conventions related to position 17 of the file name.)
Attribute	imageOrientationTypeCode	ImageOrientationTypeCode	0..1	The code that defines the orientation/plunge (i.e., camera angle) of the item as it is being depicted in the image. (More information on these codes can be found in the GS1 Product Image Specification Standard for the naming conventions related to position 18 of the file name.)

Content	Attribute / Role	Datatype /Secondary class	Multiplicity	Definition
Attribute	imageStateCode	ImageStateCode	0..1	The code that defines the state of the item as it is being depicted in the image. (More information on these codes can be found in the GS1 Product Image Specification Standard for the naming conventions related to position 19 of the file name.)
Attribute	isImageRendered	Boolean	0..1	The indicator that specifies if the image is the result of the creation of a digital likeness of a physical object with the use of a computer and software. Rendered images often do not begin with a photographic device.
Attribute	isPrimaryFile	NonBinaryLogicEnumeration	0..1	Indicates whether a URL for the specified referenced file type links to the primary file that should be used.
Attribute	alternateText	Description500	0..*	A detailed information pertaining to the image and the context for someone who is partially or fully visually impaired or blind.
Attribute	titleText	Description500	0..*	The text entered in the title tag is displayed in a popup when a user takes their mouse over to an image. The title attribute is shown along with the image, typically as a hover tooltip.
Attribute	fileSequenceNumber	nonNegativeInteger	0..1	The order based upon the referencefileTypeCode the files should be used. Examples a 360 degree image, the images need to be ordered, or a safety data sheet where each file is 1 page and should be ordered accordingly.
Association	avpList	GS1_AttributeValuePairList	0..1	The transmission of non-standard data done in a simple, flexible, and easy to use method.

3.20 Registration Information

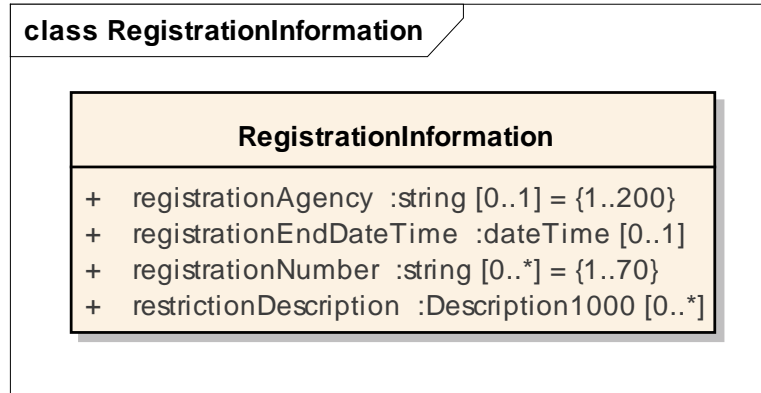

content	attribute / role	datatype /secondary class	multiplcity	definition
RegistrationInformation				Information on any registration numbers issued for the trade item.
Attribute	registrationAgency	string	0..1	An agency that issues registration numbers for any item or substance for example a chemical that is contained within the product.
Attribute	registrationEndDateTime	dateTime	0..1	The last date that the registration number is valid.
Attribute	registrationNumber	string	0..*	A registration number for any item or its constituents.
Attribute	restrictionDescription	Description1000	0..*	A description on any restrictions on usage for example locations where a pesticide cannot be sold.

3.21 Structured Address

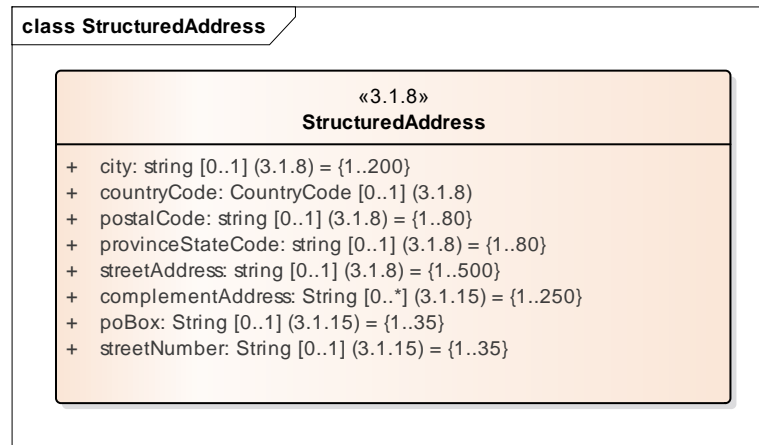

content	attribute / role	datatype /secondary class	multi plicity	definition
StructuredAddress				A simple address in a structured format.
Attribute	city	string	0..1	Text specifying the name of the city.
Attribute	complementAddress	String	0..*	The complement address expressed as a free form text. The complement address is printed on paper as additional lines below the street address. For example, an industrial zone or apartment number. Required in case the PD Organisation link is provided (Product Designer Link relates to an Organisation)
Attribute	countryCode	CountryCode	0..1	Code specifying the country for the address.
Attribute	poBox	String	0..1	The post office box for the contact.
Attribute	postalCode	string	0..1	Text specifying the postal code for an address.
Attribute	provinceStateCode	string	0..1	A code specifying a province or state in abbreviated format for example NJ.
Attribute	streetAddress	string	0..1	The street address expressed as free form text. The street address is printed on paper as the first lines below the name. Some trading partners require the street address to be the street name and number in this attribute. Others require this attribute to be just the street name. In this case, the street number should be provided separately in the street number attribute, if required.
Attribute	streetNumber	string	0..1	The street number portion of the street address for the contact.

3.22 Trade Item Material

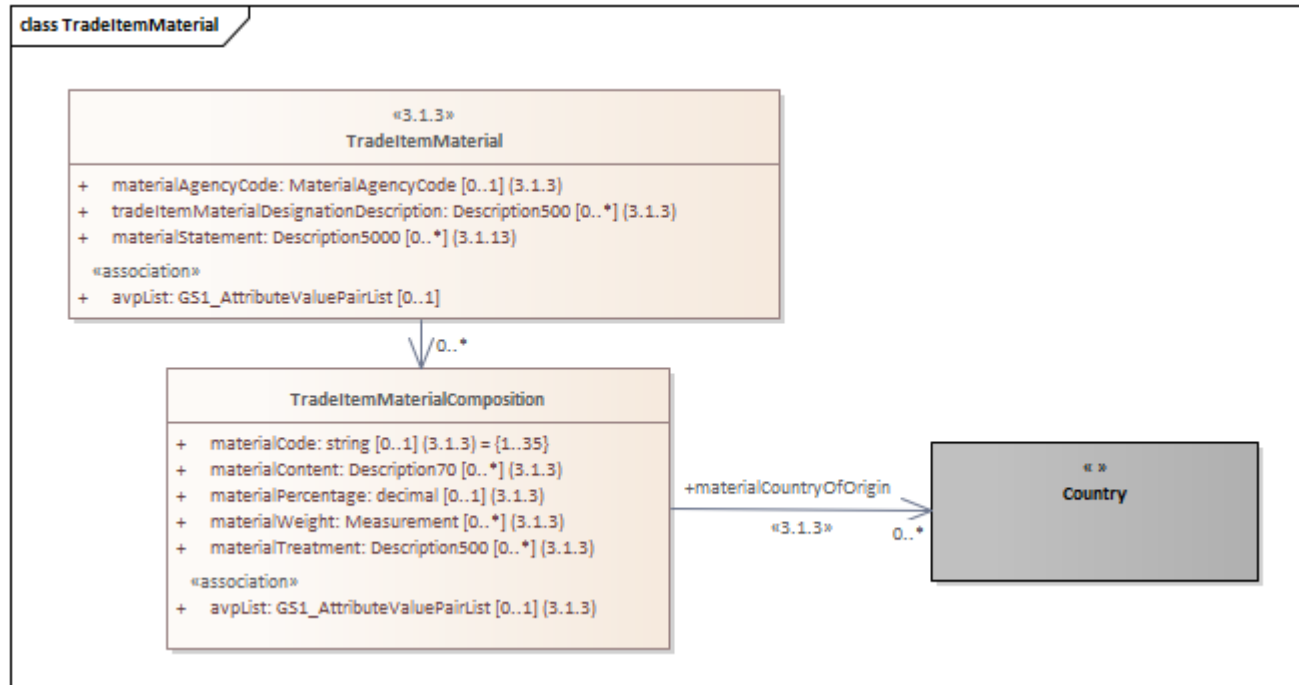

content	attribute / role	datatype /secondary class	multiplicity	definition
TradeItemMaterial				Details on the composition of any materials used to make a trade item.
Association	avpList	GS1_AttributeValuePairList	0..1	Attribute value pair information.
Association		TradeItemMaterialComposition	0..*	Details on the composition of any materials used to make a trade item.
Attribute	materialAgencyCode	MaterialAgencyCode	0..1	This element indicates the agency that is maintaining the Trade Item Material codes. This may include a specific code list.

content	attribute / role	datatype /secondary class	multiplicity	definition
Attribute	materialStatement	Description5000	0..*	Used to indicate the materials that are used in durable products. Material Statement is written as it is on the product or its label.
Attribute	tradeItemMaterialDesignationDescription	Description500	0..*	The description of the element or place on the trade item, that the material information is being described for example: filling, outer, eyes, trim.
TradeItemMaterialComposition				Details on the composition of any materials used to make the trade item.
Association	avpList	GS1_AttributeValuePairList	0..1	Attribute value pair information.
Association	materialCountryOfOrigin	Country	0..*	The country from which the material was sourced for production purposes.
Attribute	materialCode	string	0..1	This element indicates the product material code that gives the composition of the trade item's first main material up to six material short codes that can be given in descending order of their respective percentages.
Attribute	materialContent	Description70	0..*	This element is used to indicate the material composition. This element is used in conjunction with the percentage.
Attribute	materialPercentage	Decimal	0..1	Net weight percentage of a product material of the first main material. The percentages must add up to 100.
Attribute	materialWeight	Measurement	0..*	The measured weight of the material.
Attribute	materialTreatment	Description500	0..*	Indicates how the material is treated for example natural (untreated), painted, dyed, bleach, coloured, etc.

4 Core Item

4.1 Trade Item

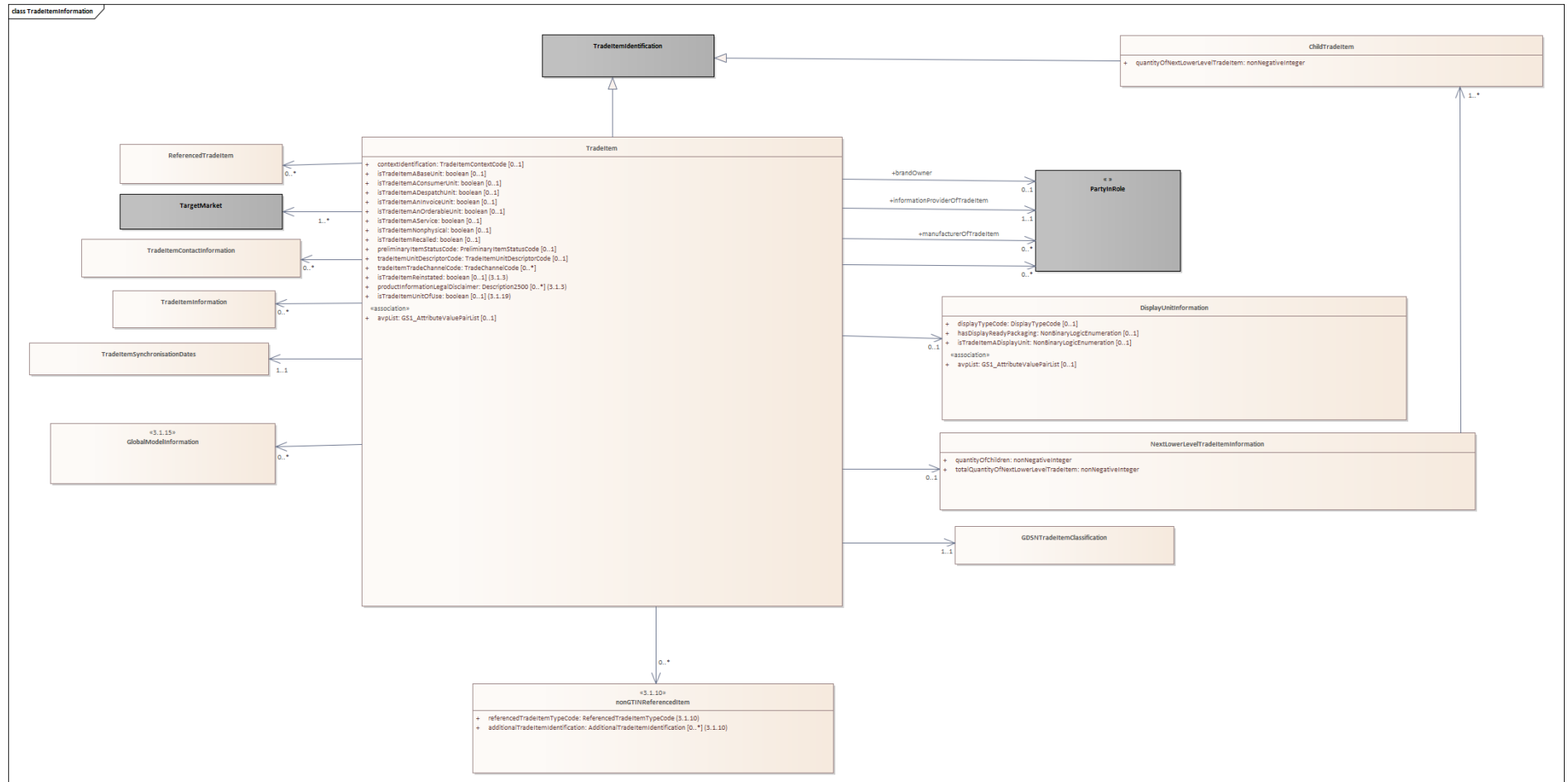

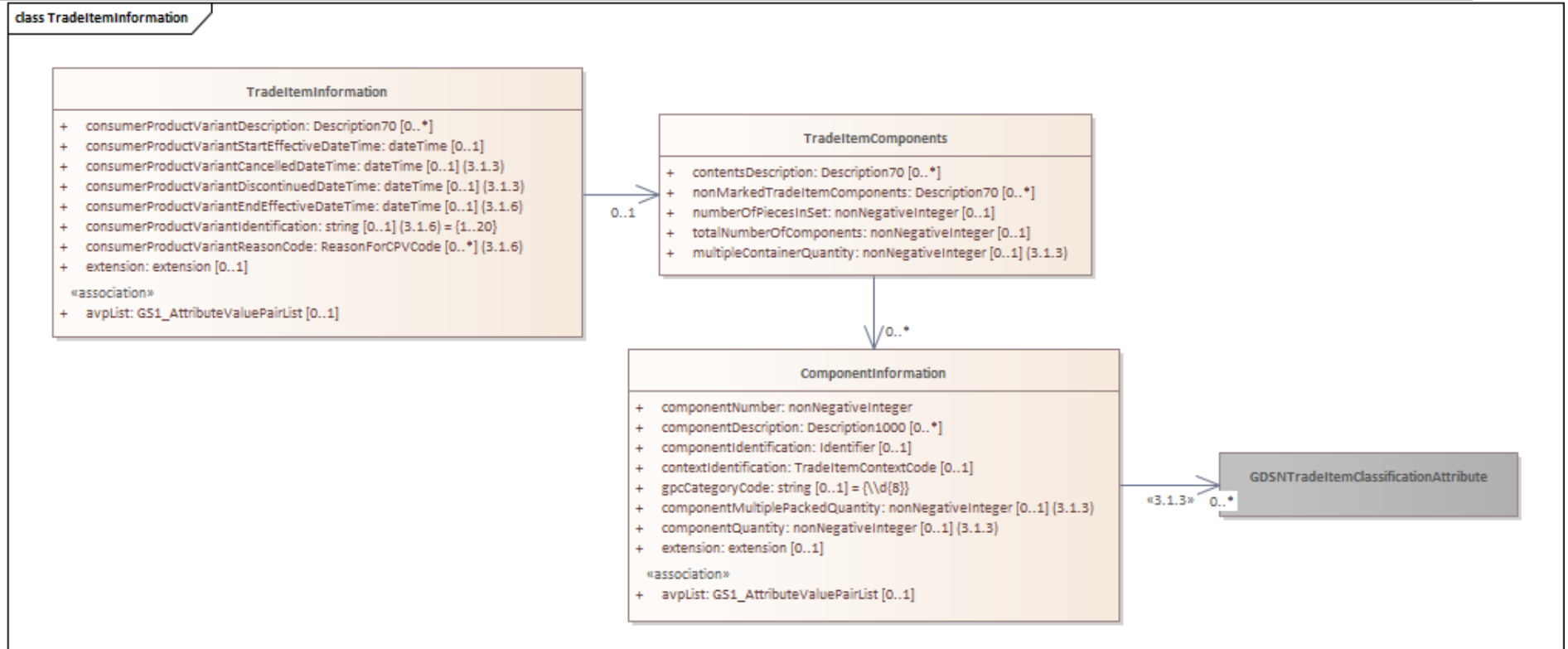

✓ **Note:** Trade Item is associated directly to the CIN.

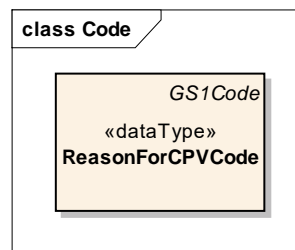

Content	Attribute / Role	Datatype /Secondary class	Multiplicity	Definition
ChildTradeItem				A trade item in the item hierarchy level immediately below the parent trade item.
Generalization		TradeItemIdentification		A trade item in the item hierarchy level immediately below the parent trade item. Note: The generalization from TradeItemIdentification brings into the ChildTradeItem class all of the attributes from TradeItemIdentification including GTIN.
Attribute	quantityOfNextLowerLevelTradeItem	nonNegativeInteger	1..1	The number of one child trade item (as identified by the association of ChildTradeItem class to TradeItemIdentification class) contained by the parent trade item. The child trade item must be in the hierarchy level immediately below the parent trade item.
nonGTINReferencedItem				The association of a non GTIN item to the core GTIN.
Attribute	referencedTradeItemTypeCode	ReferencedTradeItemTypeCode	1..1	A code depicting the type of trade item that is referenced for a specific purpose for example substitute, replaced by, equivalent trade items.
Attribute	additionalTradeItemIdentification	AdditionalTradeItemIdentification	0..*	Alternative means to the Global Trade Item Number to identify a trade item.
DisplayUnitInformation				Information on whether the item is shipped in a display unit and the type of display unit it is.
Attribute	displayTypeCode	DisplayTypeCode	0..1	A code determining the type of display a trade item is, for example Shelf Display Ready Packaging.
Attribute	hasDisplayReadyPackaging	NonBinaryLogicEnumeration	0..1	Indicates that the Trade Item has display ready packaging (also referred to as Shelf Ready Packaging or Retail Ready Packaging). Display ready packaging can be exhibited on the floor, a shelf or other location. It may or may not require some modification e.g. to raise a flap. If modifications are necessary, the measurements would be advised for the trade item as prepared for display.
Attribute	isTradeItemADisplayUnit	NonBinaryLogicEnumeration	0..1	An indicator whether or not a trade item is or could be used as a display unit. A display unit is intended to be shipped to a store without being split at a distribution centre or similar party and is intended to be displayed in a retail store either on a shelf or on the shop floor.
Association	avpList	GS1_AttributeValuePairList	0..1	The transmission of non-standard data done in a simple, flexible, and easy to use method.



Content	Attribute / Role	Datatype /Secondary class	Multiplicity	Definition
GlobalModelInformation				Group of attributes which provide information related to the Global Model Number (GMN).
Association	globalModelContactInformation	Contact	0..*	Contact information pertaining to a Global Model Number that differs from the GTIN level information.
Association		GlobalModelRegulatory Information	0..*	Regulatory information for a Global Model.
Attributes	globalModelDescription	Description250	0..*	The description of the base model. May deviate from the description of Trade Items derived from this model.
Attributes	globalModelNumber	String	1..1	The GS1 Global Model Number (GMN) is the GS1 identification key used to identify a product model or product family based on attributes common to the model or family as defined by industry or regulation. This GS1 identification key, once assigned to one product model or product family, SHALL NOT be reissued to another. The GMN SHALL NOT be used to identify a trade item.
Association	avpList	GS1_AttributeValuePairList	0..1	The transmission of non-standard data done in a simple, flexible, and easy to use method.
GlobalModelRegulatoryInformation				Regulatory information for a Global Model.
Association	globalModelRegulatoryActCountry	Country	0..*	The applicable country (ies) that the Global Model Number aligned to a regulatory act is applicable in. Use ISO3166_1 Code.
Attribute	globalModelRegulatoryAct	String	0..1	The regulatory act that the Global Model Number is aligned to.
NextLowerLevelTradeItemInformation				Information on the next lower level trade items in the trade item hierarchy.
Attribute	quantityOfChildren	nonNegativeInteger	1..1	Value indicates the number of unique next lower level trade items contained in a complex trade item. A complex trade item can contain at least 2 different GTINs.
Attribute	totalQuantityOfNextLowerLevelTradeItem	nonNegativeInteger	1..1	This represents the Total quantity of next lower level trade items that this trade item contains.
Association		ChildTradeItem	1..*	A trade item in the item hierarchy level immediately below the parent trade item.



Content	Attribute / Role	Datatype /Secondary class	Multiplicity	Definition
Attribute	consumerProductVariantDescription	Description70	0..*	Free text field describing the Consumer Product Variant change/difference.
Attribute	consumerProductVariantStartEffectiveDate Time	dateTime	0..1	The Start Effective date and time for Consumer Product Variants which the supplier determines. Can apply to products having a date mark (a best before date or expiration date) on the package that comes on or after the effective date.
Attribute	consumerProductVariantCancelledDate Time	DateTime	0..1	The date on which the cancellation of the consumer product variant launch of a trade item what was never and will never be manufactured is done.
Attribute	consumerProductVariantDiscontinuedDate Time	DateTime	0..1	Date on which the consumer product variant of the trade item, which has been manufactured, is no longer being manufactured.
Attribute	consumerProductVariantEndEffectiveDate Time	DateTime	0..1	The end effective date and time for Consumer Product Variants which the supplier determines.
Attribute	consumerProductVariantIdentification	String	0..1	The identification for a particular Consumer Product Variant. This identification is based upon guidelines and assignment to the General Specifications.
Attribute	consumerProductVariantReasonCode	ReasonForCPVCode	0..*	A code describing the impacted change (packaging change, graphics change, minor formulation, etc) for a Consumer Product Variant.
Attribute	extension	extension	0..1	An extension point for the trade item.
TradeItem				A Trade Item is any product or service upon which there is a need to retrieve pre-defined information and that may be priced, ordered or invoiced at any point in any supply chain. The term "trade item" is not to be confused with the legacy term "traded item" (now referred to within the GS1 General Specifications as 'standard trade item group' which can mean a specific product containment level, which is also called case. "Trade item" can represent any level of product containment, and also can represent a service.
Association	avpList	GS1_AttributeValuePairList	0..1	The transmission of non-standard data done in a simple, flexible, and easy to use method.

Content	Attribute / Role	Datatype /Secondary class	Multiplicity	Definition
Association	brandOwner	PartyInRole	0..1	Party name and identification information for the brand owner. May or may not be the same entity as the information provider, which actually enters and maintains data in data pools.
Association	informationProviderOfTradeItem	PartyInRole	1..1	The party providing the information about the trade item.
Association	manufacturerOfTradeItem	PartyInRole	0..*	Party name and identification information for the manufacturer of the trade item.
Association		PartyInRole	0..*	Party name and identification information for a party relevant to the trade item for example Information Provider.
Association		DisplayUnitInformation	0..1	Information on whether the item is shipped in a display unit and the type of display unit it is.
Association		NextLowerLevelTradeItemInformation	0..1	Information on the next lower level trade items in the trade item hierarchy.
Association		TargetMarket	1..*	Target Market associated with a Trade Item.
Association		GDSNTradeItemClassification	1..1	Identifies a category in the GPC and other product classifications.
Association		nonGTINReferencedItem	0..*	The association of a non GTIN item to the core GTIN.
Association		ReferencedTradeItem	0..*	A trade item referenced by this trade item for example replaced or replaced by.
Association		TradeItemInformation	0..*	Information on the trade item that can vary by context.
Association		GlobalModelInformation	0..*	Group of attributes which provide information related to the Global Model Number (GMN).
Association		TradeItemSynchronisationDates	1..1	Dates relevant to the process of trade item synchronisation for example publication date.
Association		TradeItemContactInformation	0..*	Contact details for a Trade Item.
Generalization		TradeItemIdentification		Trade Item Identification for a TradeItem.

Content	Attribute / Role	Datatype /Secondary class	Multiplicity	Definition
Attribute	contextIdentification	TradeItemContextCode	0..1	The unique identifier established for the context managed by GS1.
Attribute	isTradeItemABaseUnit	boolean	0..1	An indicator identifying the trade item as the base unit level of the trade item hierarchy.
Attribute	isTradeItemAConsumerUnit	boolean	0..1	Identifies whether the trade item to be taken possession of ,or to be consumed or used by an end user or both, as determined by the manufacturer. The end user could be, but is not limited to, a consumer as in items sold at retail, or a patient/clinician/technician in a healthcare setting, or an operator for foodservice such as restaurants, airlines, cafeterias, etc.
Attribute	isTradeItemADespatchUnit	boolean	0..1	An indicator identifying that the information provider considers the trade item as a despatch (shipping) unit. This may be relationship dependent based on channel of trade or other point to point agreement.
Attribute	isTradeItemAnInvoiceUnit	boolean	0..1	An indicator identifying that the information provider will include this trade item on their billing or invoice. This may be relationship dependent based on channel of trade or other point to point agreement.
Attribute	isTradeItemAnOrderableUnit	boolean	0..1	An indicator identifying that the information provider considers this trade item to be at a hierarchy level where they will accept orders from customers. This may be different from what the information provider identifies as a despatch unit. This may be a relationship dependent based on channel of trade or other point to point agreement
Attribute	isTradeItemAService	boolean	0..1	An indicator that the trade item is a service for example a receipt that can be used for upgrading a pre-paid phone balance, an entrance ticket to an amusement park, sporting event, theatre, service maintenance, installation service, repairs.
Attribute	isTradeItemNonphysical	boolean	0..1	An indicator that the trade item is not a physical item and as such has no dimensional manifestation. For example a computer download of software, movies or music, a service agreement, or prepaid cellular time.
Attribute	isTradeItemRecalled	boolean	0..1	An indicator for the Trade Item to determine if the Manufacturer or Supplier has recalled the product.

Content	Attribute / Role	Datatype /Secondary class	Multiplicity	Definition
Attribute	isTradeItemUnitOfUse	Boolean	0..1	An indicator that signifies that the trade item, that is identified with a GTIN, is a single instance of a numerable device/piece or the smallest package of a non-numerable device/piece. Examples: Pill in a blister pack, a bandage from a box of bandages.
Attribute	preliminaryItemStatusCode	PreliminaryItemStatusCode	0..1	A code designating whether the trade item has data that the information provider intends to correct or add values to due to pre-production unknowns (PRELIMINARY) or whether the item has attribute values that reflect go to market state (FINAL).
Attribute	tradeItemUnitDescriptorCode	TradeItemUnitDescriptorCode	0..1	Describes the hierarchical level of the trade item. The attribute tradeItemUnitDescriptorCode is mandatory. Examples: "CASE" , "PALLET".
Attribute	tradeItemTradeChannelCode	TradeChannelCode	0..*	A grouping of entities by common business model concentration used to define the distribution or marketing segmentation of products, customers and geographic areas into common groups that are supplied, serviced and measured in similar ways.
Attribute	isTradeItemReinstated	Boolean	0..1	Indicator stating the Trade Item is being reinstated and will no longer be cancelled or discontinued. The canceledDate or discontinuedDate has been altered to reflect the reinstatement.
Attribute	productInformationLegalDisclaimer	Description2500	0..*	A legal disclaimer from the information provider about the data being published in the item message.
Component Information				A constituent part of a trade item that is packaged separately.
Association	avpList	GS1_AttributeValuePairList	0..1	The transmission of non-standard data done in a simple, flexible, and easy to use method.
Association		GDSNTradeItemClassificationAttribute	0..*	GPC attribute information related to a component of a trade item.
Attribute	componentNumber	nonNegativeInteger	1..1	Indicate a sequence number of a component of a trade item.
Attribute	componentDescription	Description1000	0..*	A description of the component.
Attribute	componentIdentification	Identifier	0..1	An identifier for a component.

Content	Attribute / Role	Datatype /Secondary class	Multiplicity	Definition
Attribute	contextIdentification	TradeItemContextCode	0..1	The unique identifier established for the context managed by GS1.
Attribute	gpcCategoryCode	String	0..1	Code specifying a product category according to the GS1 Global Product Classification (GPC) standard.
Attribute	componentQuantity	nonNegativeInteger	0..1	An attribute used to describe the quantity of components described in either the componentIdentification or componentDescription.
Attribute	componentMultiplePackedQuantity	nonNegativeInteger	0..1	The quantity of containers when this component of the trade item is packed in multiple containers. If all quantity of this component is packed together into one item this attribute is not used. Example: 3 boxes = 1st box has 2 tables in it, 2 more boxes contain 2 chairs each for a total of 4. For the table component this value is 1 representing 1 box, for the chair the component value is 2 representing the 2 boxes.
Attribute	extension	Extension	0..1	An extension point for a component.
TradeItemComponents				A constituent part of a trade item that is packaged separately.
Association		ComponentInformation	0..*	Component information for a trade item.
Attribute	contentsDescription	Description70	0..*	Describes the contents of the the components of the trade item when an item is shipped in multiple containers. Note: This attribute will be deleted in a future release and should not be used.
Attribute	nonMarkedTradeItemComponents	Description70	0..*	This attribute indicates a non-saleable part of the trade item. It is used to specify components of a trade item that cannot be sold separately. Note: This attribute will be deleted in a future release and should not be used.
Attribute	numberOfPiecesInSet	nonNegativeInteger	0..1	The total quantity of components included in this trade item: E.g: for a 12 pack of yogurt (Vanilla, Chocolate and Strawberry), this would be 12.
Attribute	totalNumberOfComponents	nonNegativeInteger	0..1	The number of different types of components included in this trade item. Eg. for a 12 pack of yogurt (Vanilla, Chocolate and Strawberry) this would be 3.



Content	Attribute / Role	Datatype /Secondary class	Multiplicity	Definition
Attribute	multipleContainerQuantity	nonNegativeInteger	0..1	The quantity of containers when the complete trade item is packed in multiple containers. If all components are packed together into one item this attribute is not used. For example: 3 boxes = 1st box has 1 table, 2 more boxes with 2 chairs each, this attribute would contain the value 3, representing 3 boxes total.



4.2 GDSN Trade Item Classification

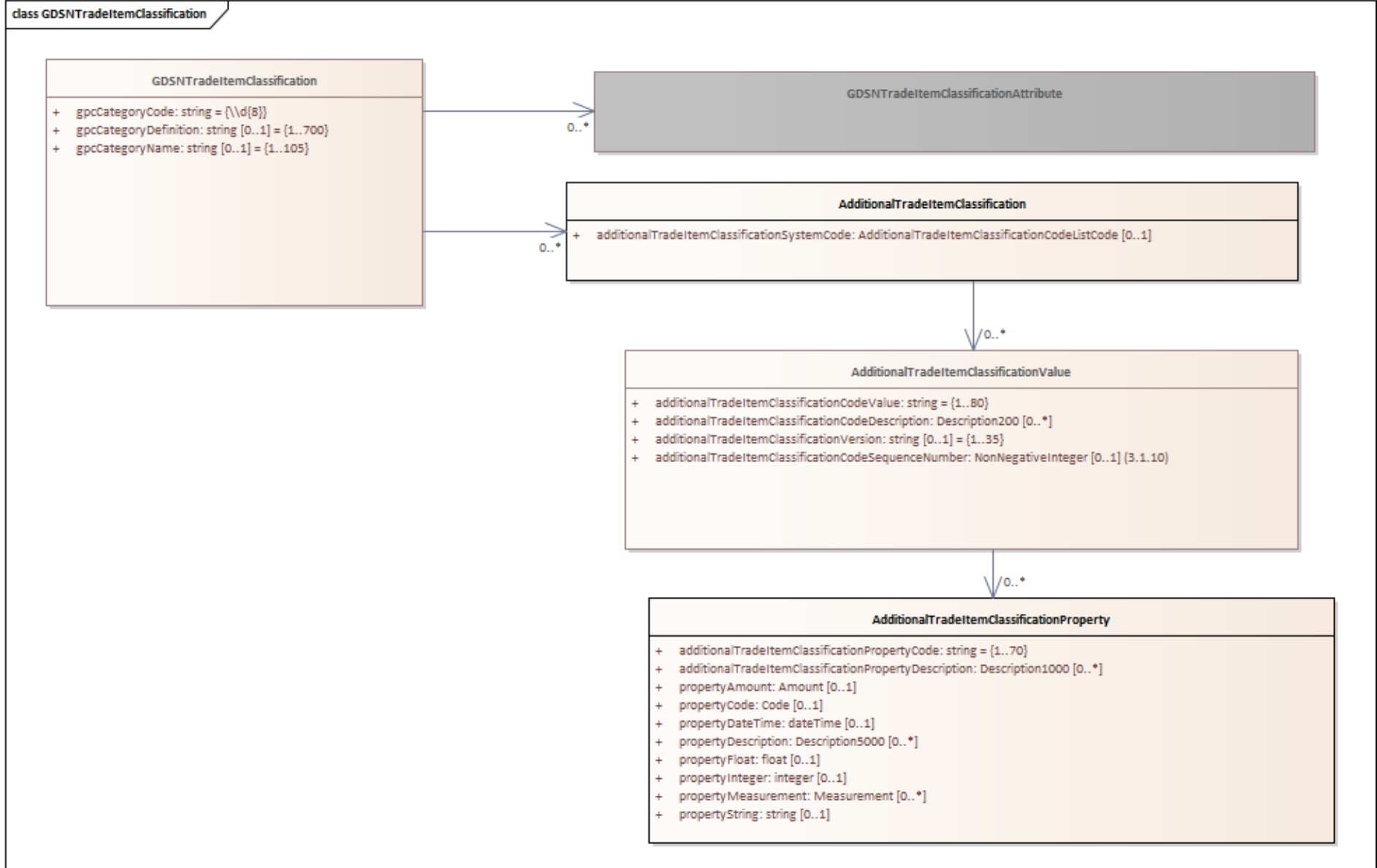

Content	Attribute / Role	Datatype /Secondary class	Multiplicity	Definition
GDSNTradeItemClassification				Information specifying the product class to which a trade item belongs and the classification system being applied.
Association		AdditionalTradeItemClassification	0..*	Information on category code based on an alternate classification schema chosen in addition to the Global Product Classification (GPC).
Association		GDSNTradeItemClassificationAttribute	0..*	Contains information, which identifies the GPC classification attribute for a trade item.
Attribute	gpcCategoryCode	string	1..1	Code specifying a product category according to the GS1 Global Product Classification (GPC) standard.
Attribute	gpcCategoryDefinition	string	0..1	A GS1 supplied definition associated with the specified Global Product Classification (GPC) category code.
Attribute	gpcCategoryName	string	0..1	Name associated with the specified Global Product Classification (GPC) category code.
AdditionalTradeItemClassification				Category code based on alternate classification schema chosen in addition to the Global Product Classification (GPC).
Association		AdditionalTradeItemClassificationValue	0..*	Code list values for an Additional Trade Item Classification Type.
Attribute	additionalTradeItemClassificationSystemCode	AdditionalTradeItemClassificationCodeListCode	0..1	The Classification System for the Additional Trade Item Classification.
AdditionalTradeItemClassificationValue				A code list value for an Additional Trade Item Classification Type.
Association		AdditionalTradeItemClassificationProperty	0..*	Characteristics that are associated with a class of trade items according to a taxonomy.
Attribute	additionalTradeItemClassificationCodeValue	string	1..1	Category code based on alternate classification schema chosen in addition to GS1 classification schema.
Attribute	additionalTradeItemClassificationCodeDescription	Description200	0..*	Description of the additional classification bundle (code/agency + description).
Attribute	additionalTradeItemClassificationVersion	string	0..1	The identification of a release of a particular product classification.

Content	Attribute / Role	Datatype /Secondary class	Multiplicity	Definition
Attribute	additionalTradeItemClassificationCodeSequenceNumber	nonNegativeInteger	0..1	A sequence number indicating the order number of the group of properties belonging together.
AdditionalTradeItemClassificationProperty				Characteristics that are associated with a class of trade items according to a taxonomy.
Attribute	additionalTradeItemClassificationPropertyCode	string	1..1	Code assigned to a property of product for a classification.
Attribute	additionalTradeItemClassificationPropertyDescription	Description1000	0..*	A description of a property of product for a specific classification. for example Waterproof.
Attribute	propertyAmount	Amount	0..1	A property of a classification of an item expressed as an amount (value and currency).
Attribute	propertyCode	Code	0..1	A property of a classification of an item expressed as a code.
Attribute	propertyDateTime	dateTime	0..1	A property of a classification of an item expressed as a date and time.
Attribute	propertyDescription	Description5000	0..*	A property of a classification of an item expressed as a description.
Attribute	propertyFloat	float	0..1	A property of a classification of an item expressed as a float for example 0.00.
Attribute	propertyInteger	integer	0..1	A property of a classification of an item expressed as an integer.
Attribute	propertyMeasurement	Measurement	0..*	A property of a classification of an item expressed as a measurement.
Attribute	propertyString	string	0..1	A property of a classification of an item expressed as text.

4.3 Referenced Trade Item

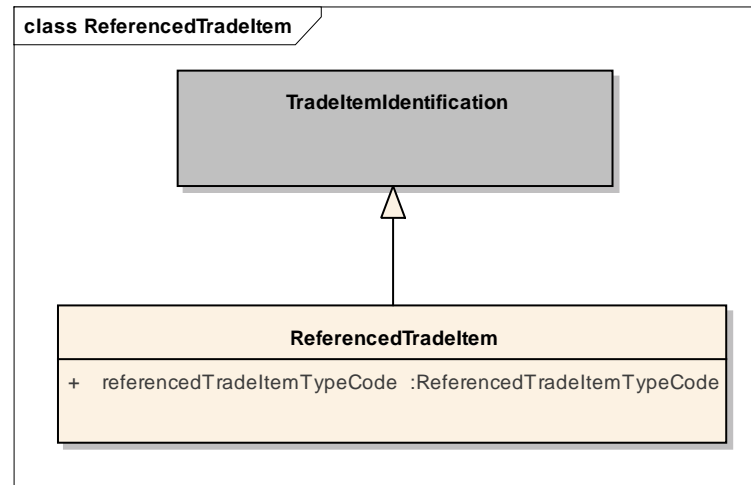

Content	Attribute / Role	Datatype /Secondary class	Multiplicity	Definition
ReferencedTradeItem				A trade item not in the trade item hierarchy that is referenced for a specific purpose for example substitute, replaced by, equivalent trade items.
Generalization		TradeItemIdentification		The identification of the referenced trade item.
Attribute	referencedTradeItemTypeCode	ReferencedTradeItemTypeCode	1..1	A code depicting the type of trade item that is referenced for a specific purpose for example substitute, replaced by, equivalent trade items.

4.4 Trade Item Contact Information

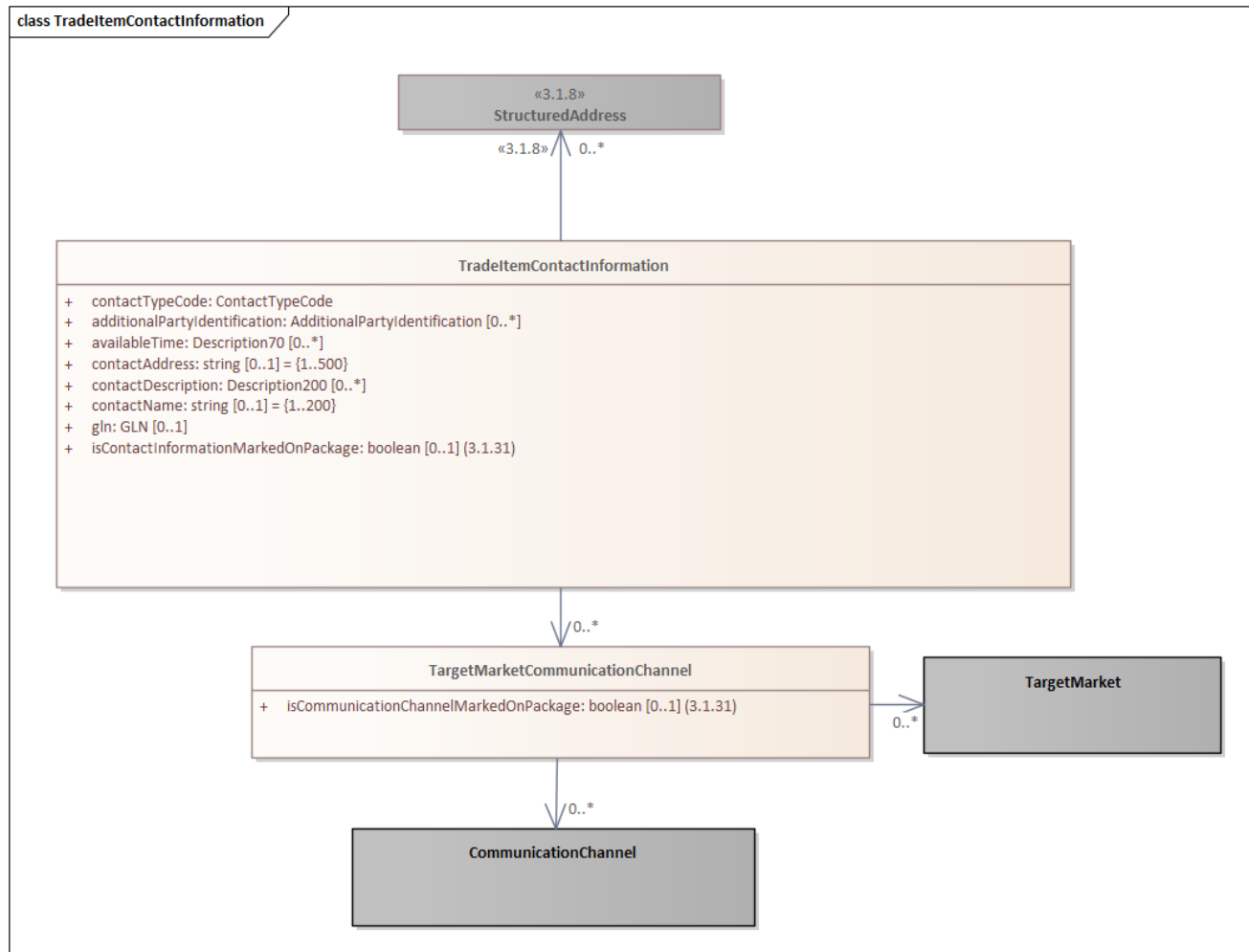

content	attribute / role	datatype /secondary class	multiplcity	definition
TradeItemContactInformation				Contact details for a Trade Item.
Association		TargetMarketCommunicationchannel	0..*	The communication channel for example phone number for a target market for a Trade Item.
Attribute	additionalPartyIdentification	AdditionalPartyIdentification	0..*	Identification of a party by use of a code other than the Global Location Number
Attribute	availableTime	Description70	0..*	The time that a specific contact for a Trade Item is available for contact.
Attribute	contactAddress	string	0..1	The address associated with the contact type. For example, in case of a contact type of consumer support, this could be the full company address as expressed on the trade item packaging or label.
Attribute	contactDescription	Description200	0..*	A description of the contact for the trade item.
Attribute	contactName	string	0..1	The name of the company or person associated with the contact type. For example, in case of a contact type of consumer support, this could be the company name as expressed on the trade item packaging or label.
Attribute	contactTypeCode	ContactTypeCode	1..1	The general category of the contact party for a trade item for example Purchasing.
Attribute	isContactInformationMarkedOnPackage	Boolean	0..1	The indicator that specifies whether the contact information is available on the product package.
Attribute	gln	GLN	0..1	The Global Location Number (GLN) is a structured Identification of a physical location, legal or functional entity within an enterprise. The GLN is the primary party identifier. Each party identified in the trading relationship must have a primary party Identification.
TargetMarketCommunicationchannel				The communication channel for example phone number for a target market for a Trade Item.
Attribute	isCommunicationChannelMarkedOnPackage	Boolean	0..1	The indicator that specifies whether the communication channel information is available on the product package.
Association		StructuredAddress	0..*	An address in a structured format for a contact.



content	attribute / role	datatype /secondary class	multiplcity	definition
Association		TargetMarket	0..*	A target market associated with a communication channel for example Canada.
Association		Communication Channel	0..*	A communication channel for a target market for example telephone.

4.5 Trade Item Synchronisation Dates

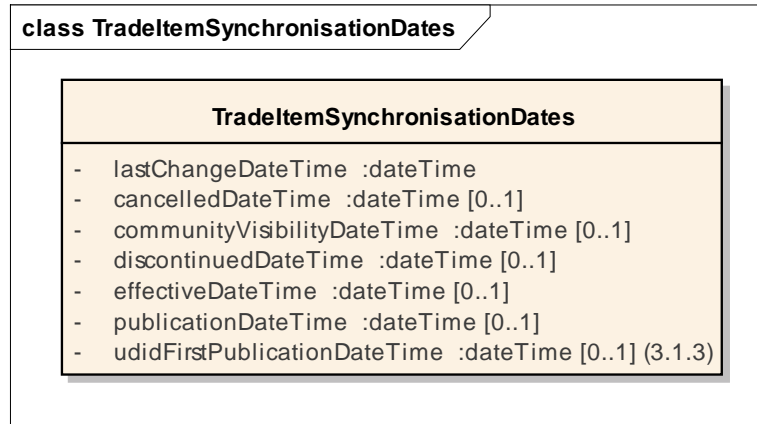

Content	Attribute / Role	Datatype /Secondary class	Multiplicity	Definition
TradeItemSynchronisationDates				Dates related to the synchronisation of a trade item within the GDS Network.
Attribute	lastChangeDateTime	dateTime	1..1	Indicates the point in time where the last modification on a Trade Item was made.
Attribute	cancelledDateTime	dateTime	0..1	Date on which the cancellation of the launch of a trade item what was never and will never be manufactured is made.
Attribute	communityVisibilityDateTime	dateTime	0..1	The date from which the neutral trade item information (i.e. not the private information, not relationship-dependent data and not price data) is available to all members of the target data pool, without restriction. Until this date only the data recipients to whom the data source has explicitly published the data can have access to the data. By setting this date a data source gives permission for wider publication of the generic item data.
Attribute	discontinuedDateTime	dateTime	0..1	Communicates the date on which the trade item is no longer to be manufactured.

Content	Attribute / Role	Datatype /Secondary class	Multiplicity	Definition
Attribute	effectiveDateTime	dateTime	0..1	The date on which the information contents of the master data version are valid. Valid = correct or true. This effective date can be used for initial trade item offering, or to mark a change in the information related to an existing trade item. This date would mark when these changes take effect.
Attribute	publicationDateTime	dateTime	0..1	A date on which all static data associated with the trade item becomes available for viewing and synchronisation.
Attribute	udidFirstPublicationDateTime	dateTime	0..1	The date upon which a Unique Device Identification Database (UDID) can publish the Trade Item Information into their public facing systems. The value can be different for each UDID GLN based on when it should be published by each UDID. Each UDID needs a single non-changeable date upon which to derive when to publish information to their public facing systems.

5 Trade Item Modules

5.1 Alcohol Information Module

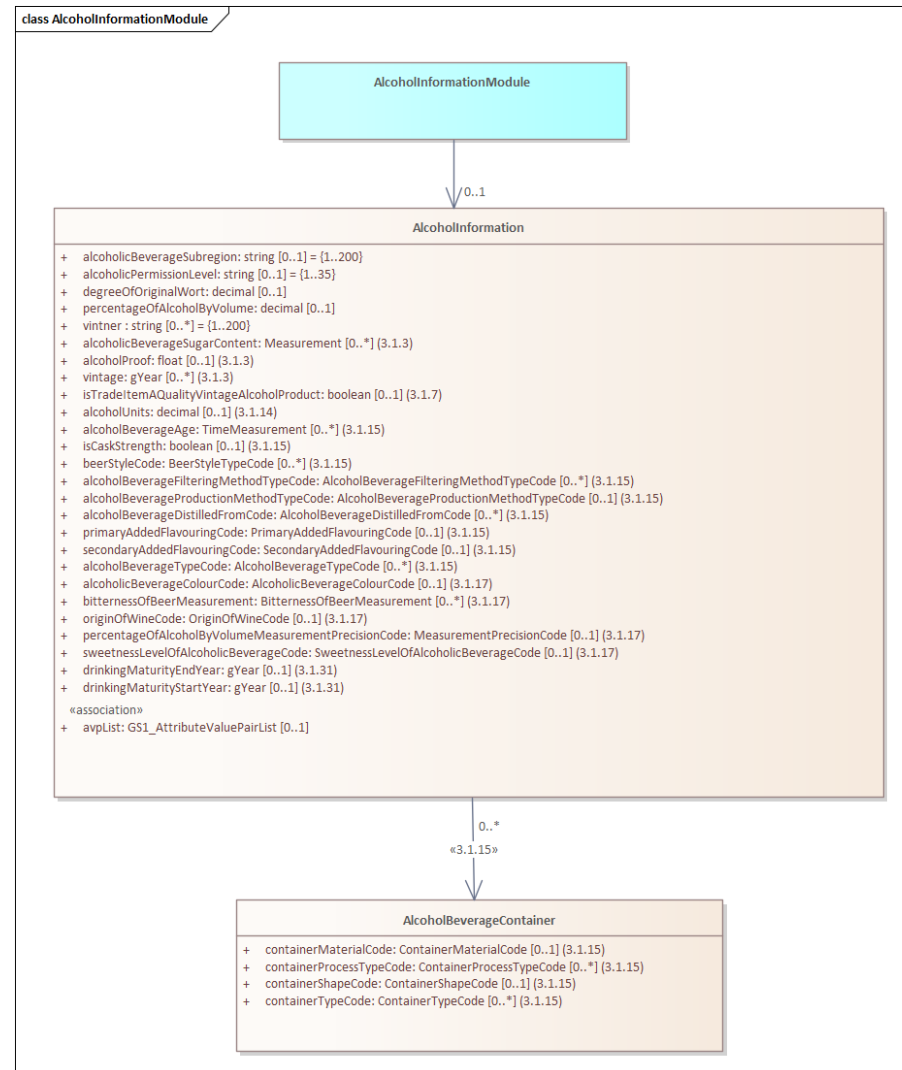

content	attribute / role	datatype /secondary class	multiplcity	definition
Attribute	containerShapeCode	ContainerShapeCode	0..1	The shape of the container used in a specific process for an alcohol product. Example: Firkin, Hogshead.
Attribute	containerTypeCode	ContainerTypeCode	0..*	The container in which the alcohol product has undergone a specific process. Example: Sherry, Rum.
AlcoholInformation				Details on products traditionally containing alcohol.
Association	avpList	GS1_AttributeValuePairList	0..1	The transmission of non-standard data done in a simple, flexible, and easy to use method.
Attribute	alcoholBeverageAge	Time Measurement	0..*	The time period which the alcohol product has been aged. For example, a whiskey aged 12 years.
Attribute	alcoholicBeverageColourCode	AlcoholicBeverageColourCode	0..1	Indicates the descriptive term that is used by the product manufacturer to identify the colour of the alcoholic beverage. Alcohol colours are sometimes qualified by a scale or regulation. Examples: Wine Regulations, Beer – EBC, SRM/Lovibond, etc.
Attribute	alcoholBeverageDistilledFromCode	AlcoholBeverageDistilledFromCode	0..*	The main ingredient(s) from which the alcohol product has been distilled. Example: Rye, Potato, Sugar Cane.
Attribute	alcoholBeverageFilteringMethodTypeCode	AlcoholBeverageFilteringMethodTypeCode	0..*	The method by which an alcohol beverage product has been filtered. Filtering is used to refine or polish the product to achieve a specific taste profile. Example: Charcoal, Chilled.
Attribute	alcoholBeverageProductionMethodTypeCode	AlcoholBeverageProductionMethodTypeCode	0..1	A method by which an alcohol beverage product has been produced. Example: Methode Traditionnelle, Added Carbonization, Chamenoise.
Attribute	alcoholicBeverageSubregion	string	0..1	A legally defined geographical region where the grapes for a wine were grown also known as an appellation.
Attribute	alcoholicBeverageSugarContent	measurement	0..*	Indication of the amount of sugar contained in the beverage for example if sugar remaining equals 6.5 g/l then enter 6.5 GL.
Attribute	alcoholBeverageTypeCode	AlcoholBeverageTypeCode	0..*	A value to provide the basic type of alcohol beverage product, for example- Spirit-Bourbon, Beer-German Bock, Still Wine-Ice Wine.
Attribute	alcoholicPermissionLevel	string	0..1	Indication of a permission level for alcoholic products dependent on the product classification. The permission level codes should reflect those of the target market.

content	attribute / role	datatype /secondary class	multiplcity	definition
Attribute	alcoholProof	float	0..1	Alcohol proof is a measure of how much ethanol (alcohol) is contained in an alcoholic beverage.
Attribute	alcoholUnits	Decimal	0..1	The number of alcohol units contained in the product as defined by local target market regulations. May also be referred to as number of standard drinks in certain geographies. Used as a measure to quantify the actual alcoholic content within the product, in order to provide guidance on total alcohol consumption. Example: 500ml of 4.5 percent ABV beer is 2.5 alcohol units in the UK and 2.0 standard drinks in Australia.
Attribute	beerStyleCode	BeerStyleCode	0..*	A value to provide a style name for beer products, such as Brown Porter, Imperial Stout, Witbier.
Attribute	bitternessOfBeerMeasurement	BitternessOfBeerMeasurement	0..*	Indicates the descriptive term that is used by the product manufacturer to identify the bitterness of beer, expressed in IBU and/or EBU .
Attribute	degreeOfOriginalWort	decimal	0..1	Specification of the degrees of original wort.
Attribute	drinkingMaturityStartYear	gYear	0..1	The year in which the drinking maturity (also known as consumption maturity) for the wine begins. It refers to the point in time at which wines develop their optimal taste.
Attribute	drinkingMaturityEndYear	gYear	0..1	The year in which the drinking maturity (also known as consumption maturity) for the wine ends. It refers to the point in time at which wines develop their optimal taste.
Attribute	isCaskStrength	boolean	0..1	Indication the alcohol beverage has not been cut, typically with water, after maturation. The resulting product has the same alcohol content as when it was removed from the maturation cask/barrel.
Attribute	isTradeItemAQualityVintageAlcoholProduct	boolean	0..1	An indicator on an alcoholic beverage trade item whether the supplier has a "declared statement of quality (in French Millésime)" or not. This "declared statement of quality" requires the "Vintage" year of harvest of the grapes to be completed.
Attribute	originOfWineCode	OriginOfWineCode	0..1	Indicates the country, region and sub-region where the wine has been produced. The levels of origin required are sometimes regulated, therefore the values represent a variety that allows a recipient to choose which level is needed.

content	attribute / role	datatype /secondary class	multiplcity	definition
Attribute	percentageOfAlcoholByVolume	decimal	0..1	Percentage of alcohol contained in the base unit trade item.
Attribute	percentageOfAlcoholByVolumeMeasurementPrecisionCode	MeasurementPrecisionCode	0..1	Indicates the precision of the measure for the percentage of alcohol by volume on label e.g. Alc. < 0,5 vol.
Attribute	primaryAddedFlavouringCode	PrimaryAddedFlavouringCode	0..1	NOTE: This attribute will be deleted in a future release. Please use tradeItemVariantGroupCode. The flavouring which has been added to the alcohol product. This is the primary addition.
Attribute	secondaryAddedFlavouringCode	SecondaryAddedFlavouringCode	0..1	NOTE: This attribute will be deleted in a future release. Please use tradeItemVariantGroupCode. The flavouring which has been added to the alcohol product. This is the secondary addition.
Attribute	sweetnessLevelOfAlcoholicBeverageCode	SweetnessLevelOfAlcoholicBeverageCode	0..1	Indicates the descriptive term that is used by the product manufacturer to identify the sweetness of the alcoholic beverage. These are sometimes placed on a label. In some markets, the term is based on the amount of sugar content according to local regulation.
Attribute	vintage	gYear	0..*	The year in which the majority of ingredients are harvested and/or the alcoholic beverage is produced. Determination as to whether the vintage year is the harvest date or production date is according to requirements in the Target Market.
Attribute	vintner	string	0..*	The person hired by a winery or wine company who is responsible for many of the processes in the preparation, taste and quality of the wine produced. The science of wine making is referred to as oenology. The vintner is the oenologist.

5.2 Allergen Information Module

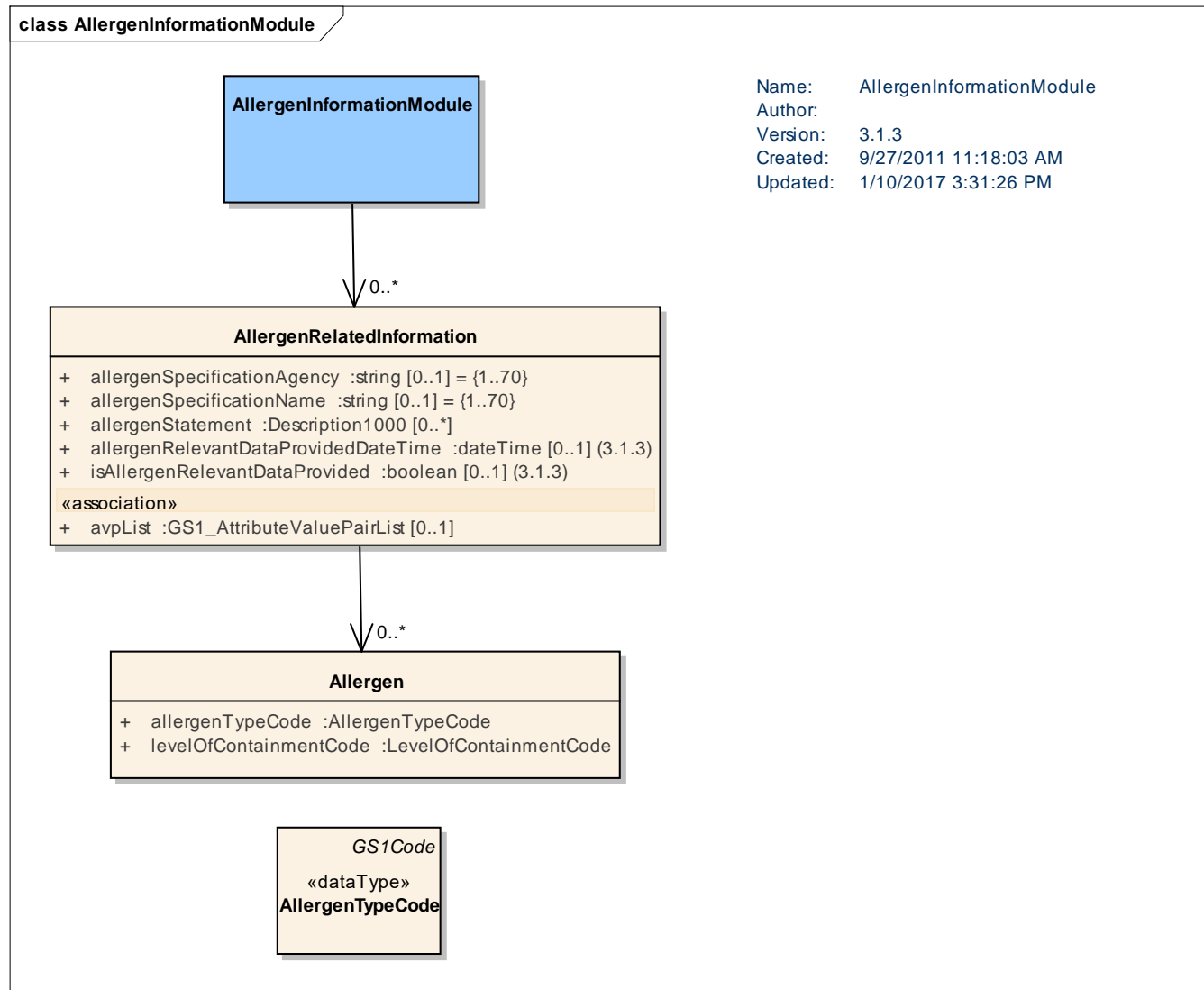

content	attribute / role	datatype /secondary class	multiplicity	definition
Allergen				Description of the presence or absence of allergens as governed by local rules and regulations, specified per allergen.
Attribute	allergenTypeCode	AllergenTypeCode	1..1	Code indicating the type of allergen.
Attribute	levelOfContainmentCode	LevelOfContainmentCode	1..1	Code indicating the level of presence of the allergen.
AllergenInformationModule				A module containing information on allergens for a trade item.
Association		AllergenRelatedInformation	0..*	Details of allergens for a trade item.
AllergenRelatedInformation				Information on substances that might cause allergic reactions and substances subject to intolerance when consumed. The allergy information refers to specified regulations that apply to the target market to which the item information is published.
Association		Allergen	0..*	Details of the allergen and the associated containment.
Association	avpList	GS1_AttributeValuePairList	0..1	The transmission of non-standard data done in a simple, flexible, and easy to use method.
Attribute	allergenSpecificationAgency	string	0..1	Note: This attribute is being deprecated in a future release. There is no longer a use case for this attribute. No need to migrate content. Agency that controls the allergen definition.
Attribute	allergenSpecificationName	string	0..1	Note: This attribute is being deprecated in a future release. There is no longer a use case for this attribute. No need to migrate content. Free text field containing the name and version of the regulation or standard that contains the definition of the allergen.
Attribute	allergenStatement	Description1000	0..*	Textual description of the presence or absence of allergens as governed by local rules and regulations, specified as one string.
Attribute	allergenRelevantDataProvidedDateTime	dateTime	0..1	The date upon which the isAllergenRelevantDataProvided indicator was last updated.



content	attribute / role	datatype /secondary class	multiplicity	definition
Attribute	isAllergenRelevantDataProvided	boolean	0..1	Determines whether allergen Information is populated for those values which are relevant or required to be populated on the product label or label equivalent. All values not populated are not relevant or not required to be populated on the product label by local regulations.

5.3 Animal Feeding Module

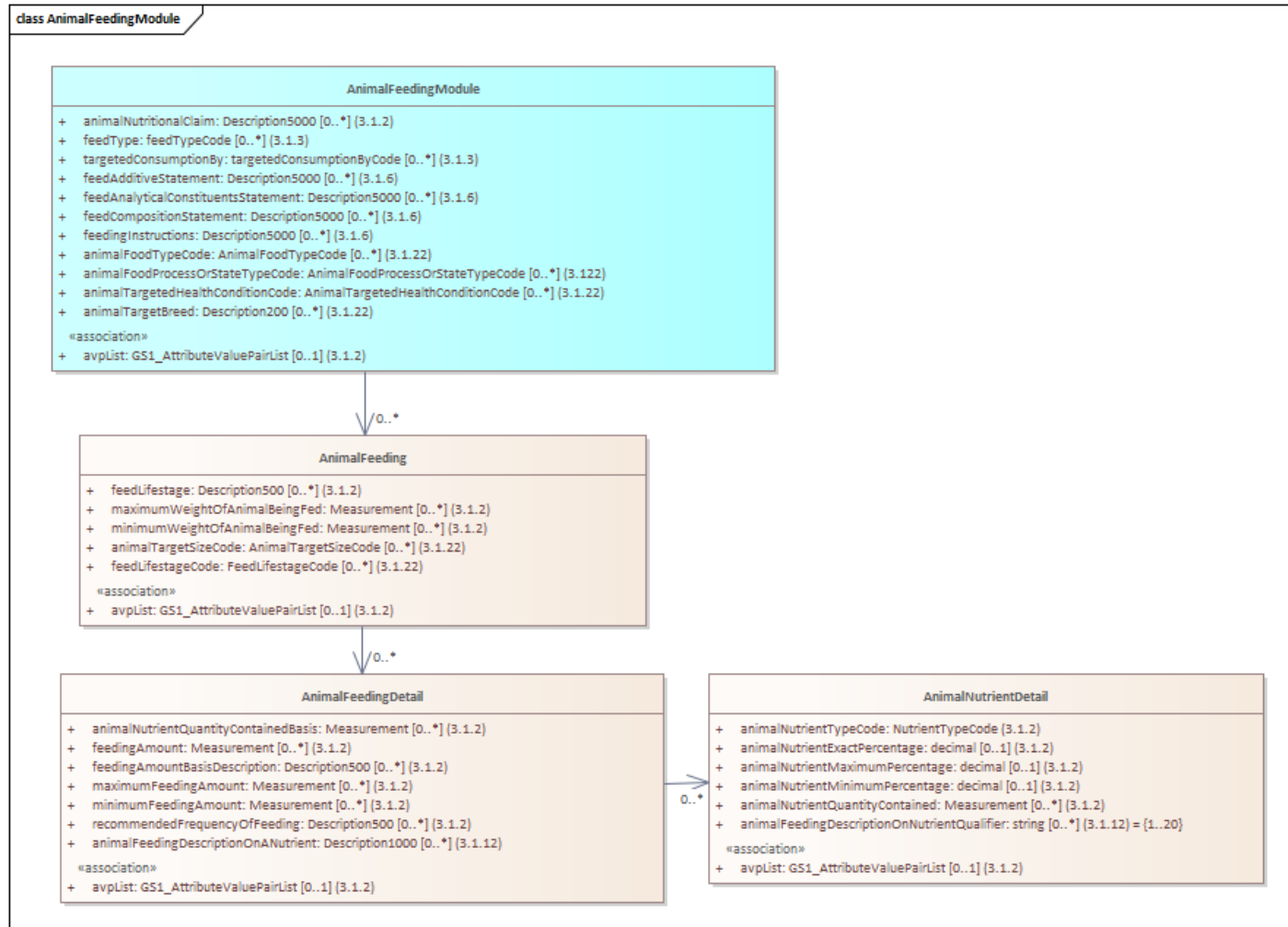



content	attribute / role	datatype /secondary class	multiplicity	definition
AnimalFeeding				Feeding directions for the trade item as it relates to different lifestages of the animal to be fed.
attribute	animalTargetSizeCode	AnimalTargetSizeCode	0..*	The code, as defined by the seller, that describes the generic size of the animal, in relation to its species, for product usage.
attribute	feedLifestageCode	FeedLifestageCode	0..*	The code, as defined by the seller, that describes the generic life stage(s) of the animal for product usage.
attribute	feedLifestage	Description500	0..*	Identifies the life-stage of the animal for which a trade item has been designed for example Adult.
attribute	maximumWeightOfAnimalBeingFed	Measurement	0..*	The highest weight (in a weight range) of the animal to be fed by the trade item. This value qualifies the quantity of feed for the feed lifestage.
attribute	minimumWeightOfAnimalBeingFed	Measurement	0..*	The lowest weight (in a weight range) of the animal to be fed by the trade item. This value qualifies the quantity of feed for the feed lifestage.
Association		AnimalFeedingDetail	0..*	Detail on animal feeding for a trade item.
attribute	avpList	GS1_AttributeValuePairList	0..1	The transmission of non-standard data done in a simple, flexible, and easy to use method.
AnimalFeedingDetail				Detail directions for feeding amount of the trade item as it relates to different life stages of the animal to be fed.

content	attribute / role	datatype /secondary class	multiplicity	definition
attribute	animalNutrientQuantityContainedBasis	Measurement	0..*	The basis amount that the animal nutrient quantity contained is measured against for example, 12 Kilograms in the case of 3 grams per 12 kilogram.
attribute	feedingAmount	Measurement	0..*	The amount of feed which is specified for the feed life-stage and qualified by the weight of animal being fed.
attribute	feedingAmountBasisDescription	Description500	0..*	The basis code to qualify the feeding amounts being specified. For example, per day.
attribute	maximumFeedingAmount	Measurement	0..*	The maximum amount of feed which is specified for the feed life-stage and qualified by the weight of animal being fed.
attribute	minimumFeedingAmount	Measurement	0..*	The minimum amount of feed which is specified for the feed life-stage and qualified by the weight of animal being fed.
attribute	recommendedFrequencyOfFeeding	Description500	0..*	How frequently it is recommended to feed an animal the quantity of feed within a time period for the specified feed life-stage. Examples: 2 feedings per day, maximum 2 chew sticks and/or 2 portions per day.
attribute	animalFeedingDescriptionOnANutrient	Description1000	0..*	Any description on a nutrient for animal feeding which cannot be expressed by using INFOODS code value
association		AnimalNutrientDetail	0..*	Nutrient information for animal feed products.
association	avpList	GS1_AttributeValuePairList	0..1	The transmission of non-standard data done in a simple, flexible, and easy to use method.
AnimalFeedingModule				A module detailing instructions on feeding animals in relation to different stages of their life.
attribute	animalNutritionalClaim	Description5000	0..*	Free text field for any additional nutritional claims in relations to animal feed.
attribute	animalFoodProcessOrStateTypeCode	AnimalFoodProcessOrStateTypeCode	0..*	The code that defines the process or physical state in which the animal food product is shipped and delivered.
attribute	animalFoodTypeCode	AnimalFoodTypeCode	0..*	The code that describes the shape or consistency of the animal food product.
attribute	animalTargetBreed	Description200	0..*	The description that identifies any breed of animal for which the animal product is designed. Examples Poodle, Golden Retriever, Koi, Betta, etc.
attribute	animalTargetedHealthConditionCode	AnimalTargetedHealthConditionCode	0..*	The code that identifies any health conditions that the animal product addresses.
Attribute	feedAnalyticalConstituentsStatement	Description5000	0..*	List of the analytical constituents or guaranteed analysis of the feed, based on the nutrient analysis of the finished product, as governed by local rules and regulations.
Attribute	feedAdditiveStatement	Description5000	0..*	List of the substances added to feed during processing, as for preservation, coloring, or stabilization as governed by local rules and regulations.

content	attribute / role	datatype /secondary class	multiplicity	definition
Attribute	feedCompositionStatement	Description5000	0..*	List of the animal feed composition data, based on the ingredients contained in the feed, as governed by local rules and regulations.
Attribute	feedingInstructions	Description5000	0..*	All instructions describing how (e.g. in which amounts or how often) the animal should be fed based on the age, weight, diet or other variables, expressed as a free text. Information provided shall be identical as on the label or pack.
attribute	feedType	FeedTypeCode	0..*	The type of pet food or feed given to wild or domestic animals in the course of animal husbandry, e.g. feed material, complete feed, complementary feed.
attribute	targetedConsumptionBy	TargetedConsumptionByCode	0..*	The type of animal this food is intended to be consumed by for example RABBIT.
association		AnimalFeeding	0..*	Animal feeding directions for an animal.
Association	avpList	GS1_AttributeValuePairList	0..1	The transmission of non-standard data done in a simple, flexible, and easy to use method.
AnimalNutrientDetail				Nutrient information for animal feed products.
attribute	animalNutrientExactPercentage	decimal	0..1	The guaranteed percentage of the specified nutrient contained in the trade item.
attribute	animalNutrientMaximumPercentage	decimal	0..1	Maximum guaranteed percentage of the specified nutrient contained in the trade item.
attribute	animalNutrientMinimumPercentage	decimal	0..1	Minimum guaranteed percentage of the specified nutrient contained in the trade item.
attribute	animalNutrientQuantityContained	Measurement	0..*	Measurement value indicating the amount of the nutrient contained in the animal food or nutrition product. It is expressed relative to the animal nutrient quantity contained basis measurement. For example, 3 grams in the case of 3 grams per 12 kilogram. Allows for the representation of the same value in different units of measure but not multiple values.
attribute	animalNutrientTypeCode	NutrientTypeCode	1..1	A code identifying nutrients contained in the animal food or nutrition product.
attribute	animalFeedingDescriptionOnNutrientQualifier	String {1..20}	0..*	The qualifier from the descriptionOnNutrient applies to a specific nutrient. Sometimes an actual nutrient quantity or % are not given, instead only a qualifier. Example animalFeedingDescriptionOnNutrient = * Daily Value Intake does not apply. Then this would only be the * at the nutrient level. Examples include *, @, etc.
association	avpList	GS1_AttributeValuePairList	0..1	The transmission of non-standard data done in a simple, flexible, and easy to use method.

5.4 Apparel Information Module

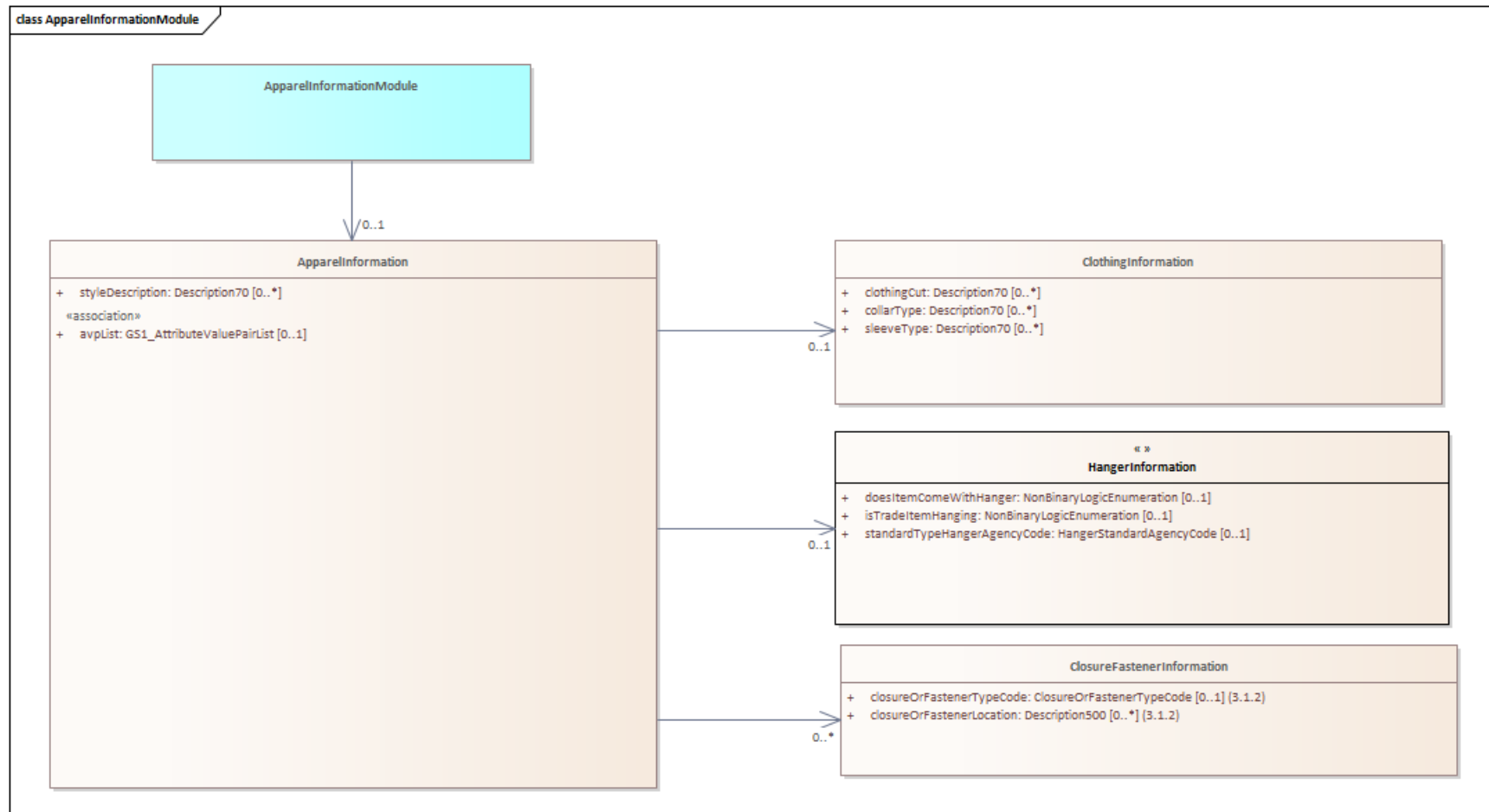

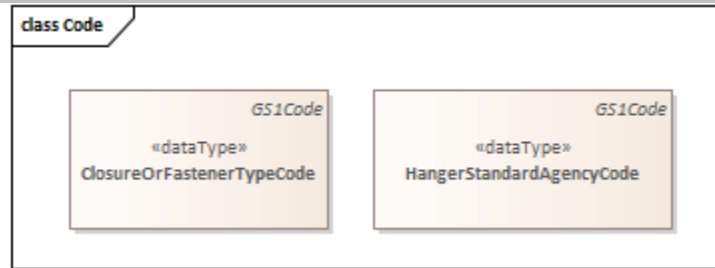

content	attribute / role	datatype /secondary class	multipl city	definition
ApparelInformation				Details specific to apparel trade items.
Association	avpList	GS1_AttributeValuePairList	0..1	The transmission of non-standard data done in a simple, flexible, and easy to use method.
Association		ClothingInformation	0..1	Information related to clothing.
Association		HangerInformation	0..1	Information on hangers for the apparel item.
Association		ClosureFastenerInformation	0..*	Details on the closure or fastener in or on the trade item.
Attribute	styleDescription	Description70	0..*	A description of the style of GTINs that share many of the similar characteristics and are recognizable types of products by the consumer.
ApparelInformation Module				A module containing details specific to apparel trade items.
Association		ApparelInformation	0..1	Details specific to apparel trade items.
ClosureFastenerInformation				Details on the closure or fastener in or on the trade item.
attribute	closureOrFastenerTypeCode	ClosureOrFastenerTypeCode	0..1	A code to identify the type(s) of closure or fastener in or on the trade item. For example: zipper, hook and loop, button, etc..
attribute	closureOrFastenerLocation	Description500	0..*	The location on the trade item of the zipper, snap, button, etc..
ClothingInformation				Information related to clothing.
Attribute	clothingCut	Description70	0..*	Supplemental information to indicate the clothing cut or silhouette make of the garment. For example: silhouette details for a pair of jeans such as boot cut, or loose fit, "Comfort Fit".
Attribute	collarType	Description70	0..*	A free text description that identifies the type of collar on the garment.
Attribute	sleeveType	Description70	0..*	A free text description of the garment sleeve type.
HangerInformation				Contains information regarding any hanger included with product.

content	attribute / role	datatype /secondary class	multiplcity	definition
Attribute	doesItemComeWithHanger	boolean	0..1	A boolean value that indicates whether or not the trade item comes with a hanger.
Attribute	isTradeItemHanging	NonBinaryLogicEnumeration	0..1	An indicator whether or not the trade Item is shipped hanging, as opposed to being shipped with a hanger but not actually hanging.
Attribute	standardTypeHangerAgencyCode	HangerStandardAgencyCode	0..1	A code that identifies the agency that specifies industry standards for hangers.

5.5 Audience Or Player Information Module

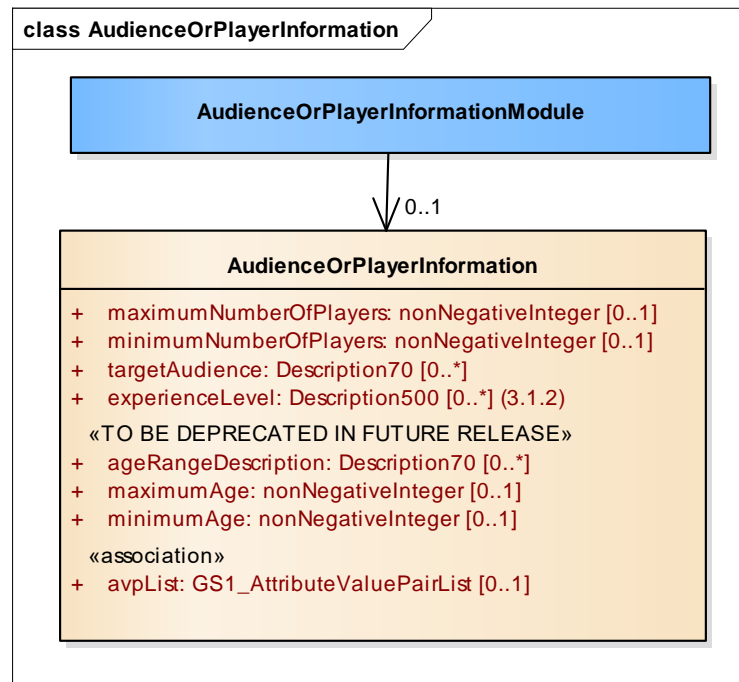

Content	Attribute / Role	Datatype /Secondary class	Multipl icity	Definition
AudienceOrPlayerInformationModule				Logical grouping of information regarding audience or player information.
Association		AudienceOrPlayerInformation	0..1	Logical grouping of information regarding audience or player information.
AudienceOrPlayerInformation				Logical grouping of information regarding audience or player information.
Association	avpList	GS1_AttributeValuePairList	0..1	The transmission of non-standard data done in a simple, flexible, and easy to use method.
Attribute	ageRangeDescription	Description70	0..*	Note: This attribute is being deprecated in a future release. Use targetConsumerAge from TargetConsumer class in MarketingInformationModule. Description of the recommended age range of participating players.
Attribute	experienceLevel	Description500	0..*	The level of experience or expertise required to use the equipment or device for example: Beginner, Intermediate, Advanced.
Attribute	maximumAge	nonNegativeInteger	0..1	Note: This attribute is being deprecated in a future release. Use targetConsumerUsageTypeCode with the value AGE and targetConsumerMaximumUsage from TargetConsumerUsage class in MarketingInformationModule. Recommended oldest age for a game or publication.
Attribute	maximumNumberOfPlayers	nonNegativeInteger	0..1	Maximum number of players that can participate in the game.
Attribute	minimumAge	nonNegativeInteger	0..1	Note: This attribute is being deprecated in a future release. Use targetConsumerUsageTypeCode with the value AGE and targetConsumerMinimumUsage from TargetConsumerUsage class in MarketingInformationModule. Recommended youngest age for a game or publication.
Attribute	minimumNumberOfPlayers	nonNegativeInteger	0..1	Minimum number of players that can participate in the game.
Attribute	targetAudience	Description70	0..*	A description of the recommended audience of the music publication.

5.6 Audio Visual Media Content Information Module

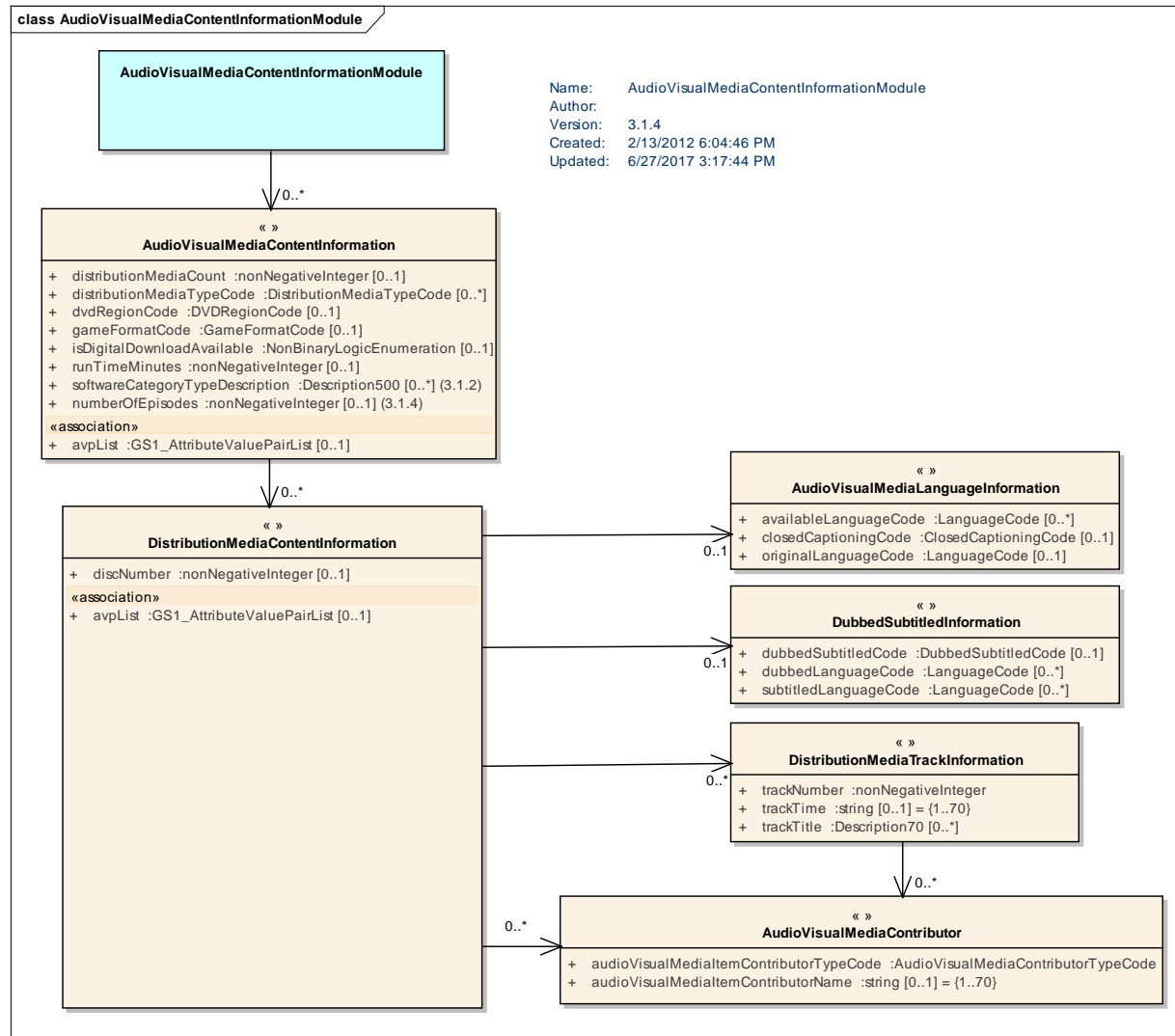

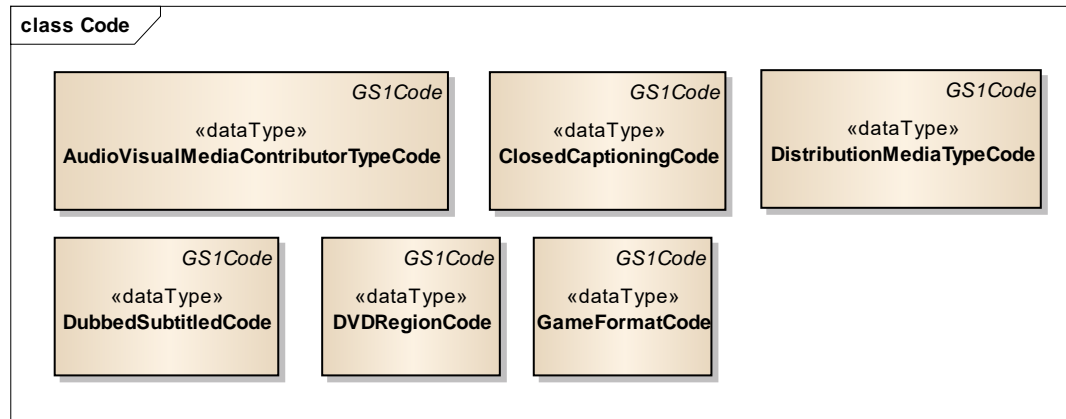

Content	Attribute / Role	Datatype / Secondary class	Multiplicity	Definition
AudioVisualMediaContentInformationModule				Information on the media included in the package for the purposes of storing the software, games, music, films.
Association		AudioVisualMediaContentInformation	0..*	Information on the media included in the package for the purposes of storing the software, games, music, films.
AudioVisualMediaContentInformation				Information on the media included in the package for the purposes of storing the software, games, music, films.
Association	avpList	GS1_AttributeValuePairList	0..1	The transmission of non-standard data done in a simple, flexible, and easy to use method.
Association		DistributionMediaContentInformation	0..*	Information on the content of the distribution media.
Attribute	distributionMediaCount	nonNegativeInteger	0..1	The quantity of media storage devices that are included in the package for the purposes of storing the software.
Attribute	distributionMediaTypeCode	DistributionMediaTypeCode	0..*	The type of media storage devices that are included in the package for the purposes of storing the software for example memory sticks, discs, cartridges.

Content	Attribute / Role	Datatype /Secondary class	Multiplicity	Definition
Attribute	dvdRegionCode	DVDRegionCode	0..1	A code that identifies the region in which the DVD will be sold. Only DVDs and DVD players with matching codes will work unless the DVD player has been "de-zoned".
Attribute	gameFormatCode	GameFormatCode	0..1	Code that identifies the electronic environment or system needed to use the electronic game. For example X-Box, Game Cube, PS2
Attribute	isDigitalDownloadAvailable	NonbinaryLogicEnumeration	0..1	Indicates if the title is available in the digital download format.
Attribute	runTimeMinutes	nonNegativeInteger	0..1	The length of a media item expressed in minutes.
Attribute	softwareCategoryTypeDescription	Description500	0..*	The general category of software by which the item is most closely associated, computers, mobile, GPS, gaming, marine etc..
Attribute	numberOfEpisodes	nonNegativeInteger	0..1	The number of episodes in the season or set for example 2, 3 or 4.
AudioVisualMediaContributor				Information on the contributor to the audio, visual media item for example artist or producer.
Attribute	audioVisualMediaItemContributorTypeCode	AudioVisualMediaContributorTypeCode	1..1	A code identifying the type of contributor to media content for example artist, producer, director.
Attribute	audioVisualMediaItemContributorName	string	0..1	The name of the contributor of the media content for example artist, producer, director.
AudioVisualMediaLanguageInformation				Logical Grouping of Information relating to the language of an audio, visual or media related trade item..
Attribute	availableLanguageCode	LanguageCode	0..*	The available languages used to interface with the consumer.
Attribute	closedCaptioningCode	ClosedCaptioningCode	0..1	A code that indicates if the film has closed captions, no closed captions or if this information is unknown.
Attribute	originalLanguageCode	LanguageCode	0..1	The code of the language in which the film is released. It is the language spoken on the screen.
DubbedSubtitledInformation				Logical grouping of subtitle information.

Content	Attribute / Role	Datatype / Secondary class	Multiplicity	Definition
Attribute	dubbedSubtitledCode	DubbedSubtitledCode	0..1	A code that indicates if the film is dubbed, subtitled or dubbed and subtitled. Subtitled = the film has caption translating dialogue. Dubbed = The film has a translated alternative soundtrack. Dubbed and subtitled = the film has caption to translate dialogue and a translated soundtrack.
Attribute	dubbedLanguageCode	LanguageCode	0..*	A code that identifies the dubbed language of a film.
Attribute	subtitledLanguageCode	LanguageCode	0..*	A code that identifies the language used in a trade item's subtitles.
DistributionMediaContentInformation				Logical grouping of information relating to the content of a particular distribution media.
Association	avpList	GS1_AttributeValuePairList	0..1	The transmission of non-standard data done in a simple, flexible, and easy to use method.
Association		DubbedSubtitledInformation	0..1	Logical grouping of subtitle information.
Association		DistributionMediaTrackInformation	0..*	Logical grouping of information relating to the content of a particular distribution media
Association		AudioVisualMediaLanguageInformation	0..1	Language information for the audio visual media product.
Association		AudioVisualMediaContributor	0..*	Information on any contributors to the audio visual media item for example producer.
Attribute	discNumber	nonNegativeInteger	0..1	The number allocated to a disc, beginning with 1
DistributionMediaTrackInformation				Logical grouping of information relating to the content of a particular distribution media
Association		AudioVisualMediaContributor	0..*	Information on any contributors to the audio visual media item for example producer.
Attribute	trackNumber	nonNegativeInteger	1..1	The number allocated to a disc, beginning with 1
Attribute	trackTime	string	0..1	The length of the track expressed in hours and minutes and seconds.
Attribute	trackTitle	Description70	0..*	The name of the the track or section of the audio visual media trade item.

5.7 Audio Visual Media Product Description Information Module

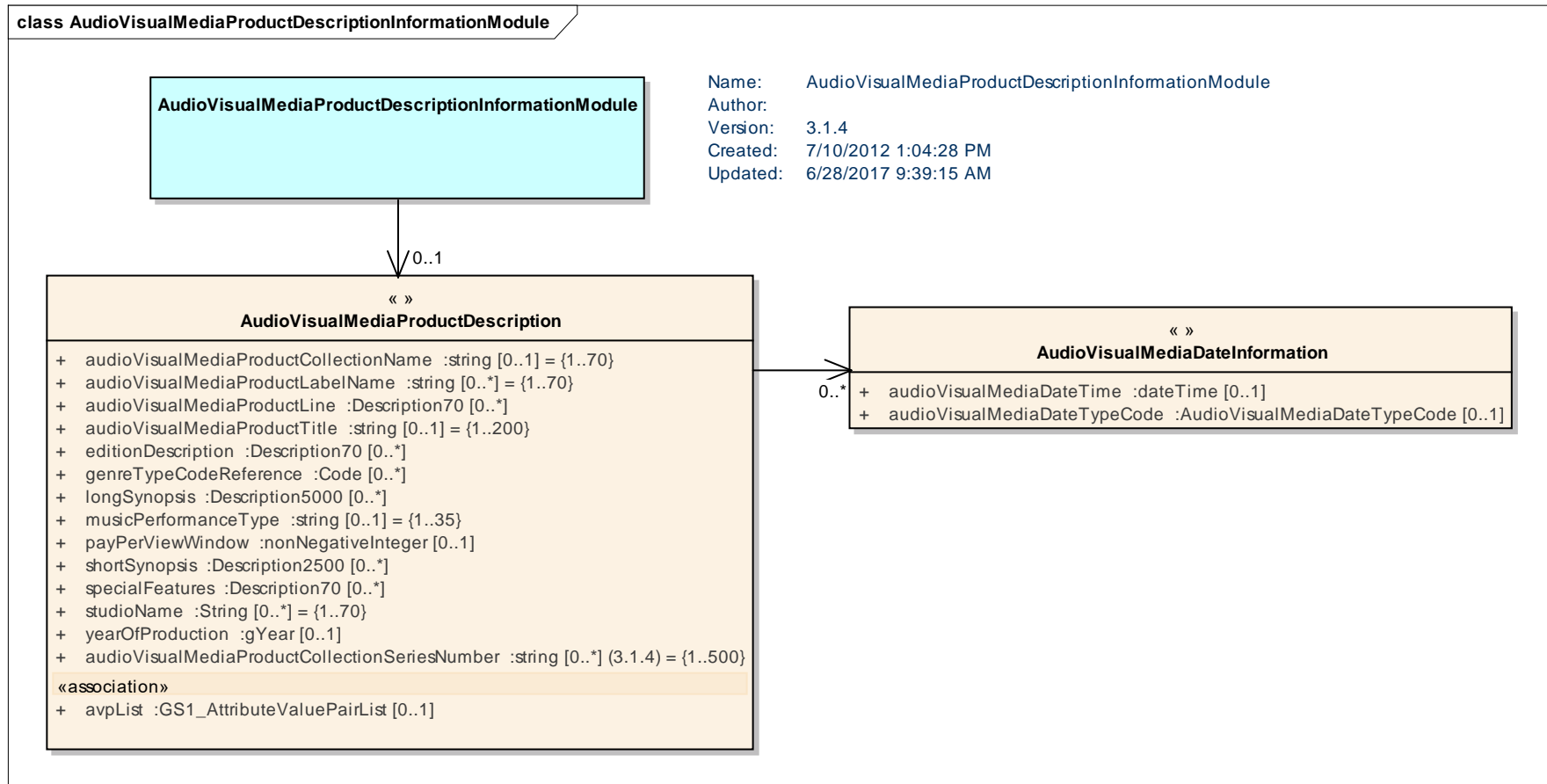

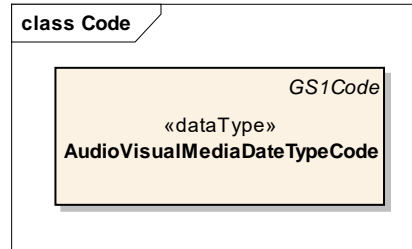

Content	Attribute / Role	Datatype / Secondary class	Multiplicity	Definition
AudioVisualMediaDateInformation				Information on dates that are specific to audio visual media products for example release date.
Attribute	audioVisualMediaDateTime	dateTime	0..1	The date for audio or visual media products for example release date.
Attribute	audioVisualMediaDateTypeCode	AudioVisualMediaDateTypeCode	0..1	A code specifying the type of date for audio or visual media products for example release date.
AudioVisualMediaProductDescriptionInformationModule				A module containing information on the genre and content of an entertainment related product (eg. movies, music) including format and genre.
Association		AudioVisualMediaProductDescription	0..1	Information on the genre and content of an entertainment related product (eg. movies, music) including format and genre.
AudioVisualMediaProductDescription				Information on the genre and content of an entertainment related product (eg. movies, music) including format and genre.
Association	avpList	GS1_AttributeValuePairList	0..1	The transmission of non-standard data done in a simple, flexible, and easy to use method.
Association		AudioVisualMediaDateInformation	0..*	Date information for an audio or visual media product.
Attribute	audioVisualMediaProductCollectionName	string	0..1	The name of a series of music publications grouped under a common theme. The name of the collection is printed on the package of the trade item.
Attribute	audioVisualMediaProductLabelName	string	0..*	The name of the company (called label in the music industry) that made the music publication.

Content	Attribute / Role	Datatype / Secondary class	Multiplicity	Definition
Attribute	audioVisualMedia ProductLine	Description70	0..*	The name of the product line that the trade item belongs to. A product line is a price grouping.
Attribute	audioVisualMedia ProductTitle	string	0..1	Title of the audio visual media product.
Attribute	editionDescription	Description70	0..*	A text that describes the edition of the audio or visual media product.
Attribute	genreTypeCodeReference	Code	0..*	The code of the genre of media item. The genre is a categorization of the trade item based upon the content and is maintained for marketing and merchandising purposes. The GS1 Code List used differs based on product: <ul style="list-style-type: none"> • Product Genre Type Code (Electronic Games) • Product Genre Type Code (Film) • Product Genre Type Code (Music).
Attribute	longSynopsis	Description5000	0..*	An extended text that describes the plot of a film.
Attribute	musicPerformanceType	string	0..1	A text description that indicates the conditions in which the recording took place.
Attribute	payPerViewWindow	nonnegativeinteger	0..1	The number of days of the pay per view window. The pay per view window is the timeframe when a film is available as pay per view on a cable TV channel.
Attribute	shortSynopsis	Description2500	0..*	A short text that describes the plot of a film.
Attribute	specialFeatures	Description70	0..*	A text that describes the contents of the trade item in terms of special features. This is not related to a specific disk.
Attribute	studioName	string	0..*	The name of the company (called studio in the film industry) that made the publication.
Attribute	yearOfProduction	gYear	0..1	The year during which the film was produced.
Attribute	audioVisualMedia ProductCollection SeriesNumber	string	0..*	Denotes which part of the series the media is part of for example Halloween II, Law & Order 7, South Park Season 12, Terminator 3, Star Wars II.

5.8 Audio Visual Media Production Information Module

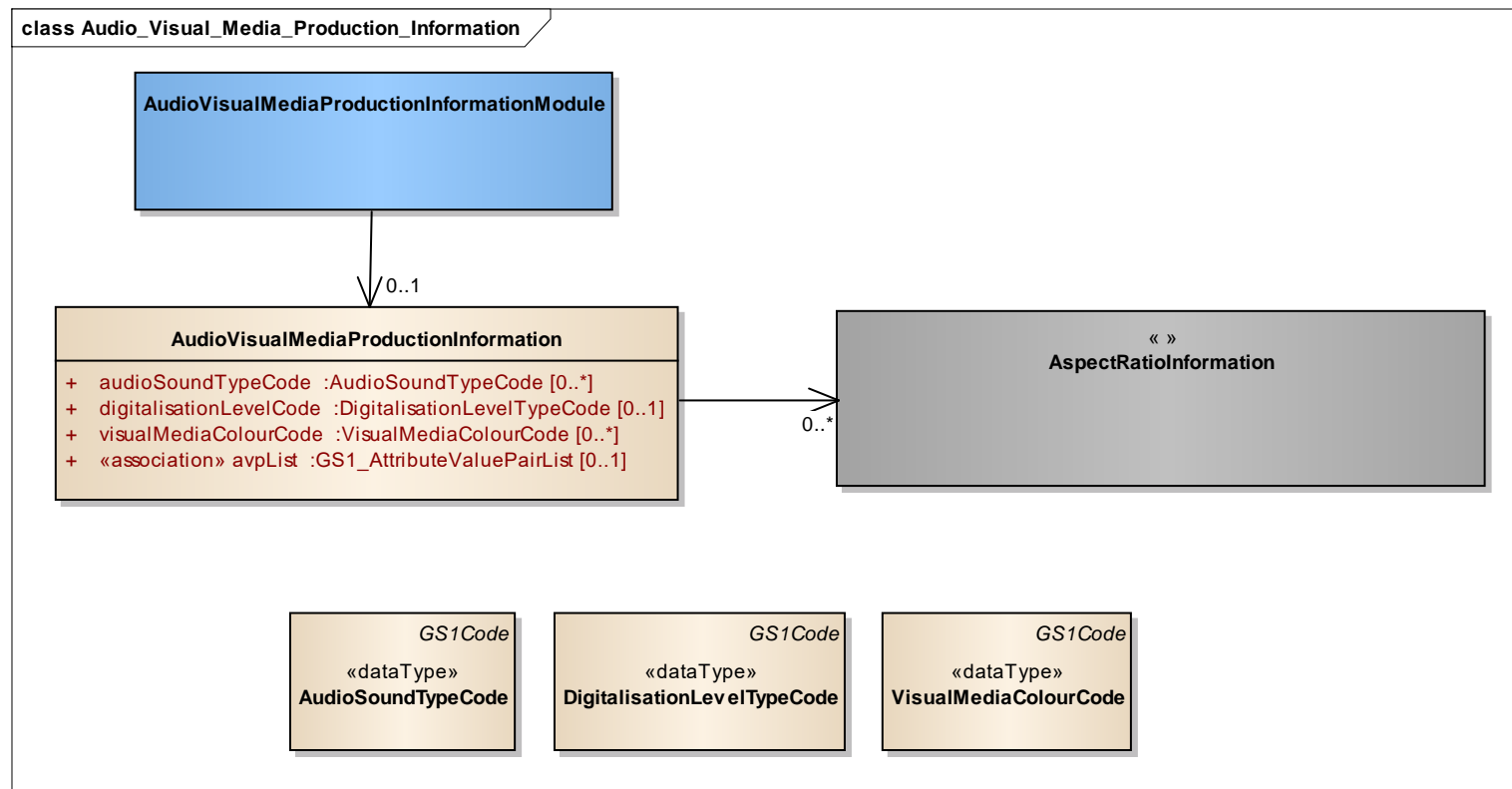

Content	Attribute / Role	Datatype /Secondary class	Multiplcity	Definition
AudioVisualMediaProductionInformation				Information on the production of the audio, visual or media publication.
Association	avpList	GS1_AttributeValuePairList	0..1	The transmission of non-standard data done in a simple, flexible, and easy to use method.
Association		AspectRatioInformation	0..*	Aspect Ratio information for an audio visual media product.
Attribute	audioSoundTypeCode	AudioSoundTypeCode	0..*	A code that indicates the type of audio sound available on the trade item.
Attribute	digitalisationLevelCode	DigitalisationLevelTypeCode	0..1	A code that indicates the way a record was produced. Three stages are involved in production: recording, editing/mixing and dubbing/transfer. Recording and editing/mixing stages can be analogue or digital. If digital, the stage is coded D. If analogue, the stage is coded A. "ADD" means that the recording was analogue and the editing/mixing was digital.
Attribute	visualMediaColourCode	VisualMediaColourCode	0..*	A code that indicates the colour system used in a film publication.
AudioVisualMediaProductionInformationModule				Information on the production of the audio.
Association		AudioVisualMediaProductionInformation	0..1	Information on the production of the audio.

5.9 Award Prize Module

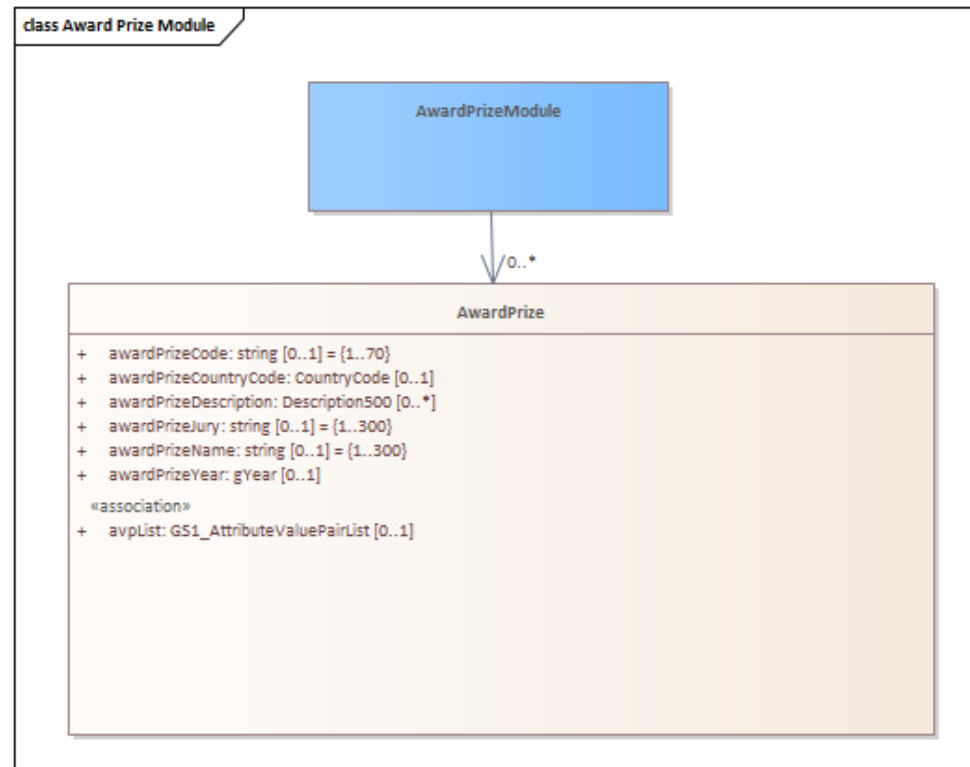

content	attribute / role	datatype /secondary class	multiplicity	definition
AwardPrize				Describes a prize or award won by the product.
Association	avpList	GS1_AttributeValuePairList	0..1	The transmission of non-standard data done in a simple, flexible, and easy to use method.
Attribute	awardPrizeCode	string	0..1	Indicates the achievement of the product in relation to a prize or award, eg winner, runner-up, shortlisted. Optional and non-repeating.
Attribute	awardPrizeCountryCode	CountryCode	0..1	An ISO standard code identifying the country in which a prize or award is given

content	attribute / role	datatype /secondary class	multipl icity	definition
Attribute	awardPrizeD escription	Description500	0..*	A text that describes the awards a film won.
Attribute	awardPrizeJu ry	string	0..1	Free text listing members of the jury that awarded the prize.
Attribute	awardPrizeN ame	string	0..1	The name of a prize or award which the product has received.
Attribute	awardPrizeY ear	gYear	0..1	The year in which a prize or award was given.
AwardPrizeMo dule				A module describing a prize or award won by the product.
Association		AwardPrize	0..*	Describes a prize or award won by the product.

5.10 Battery Information Module

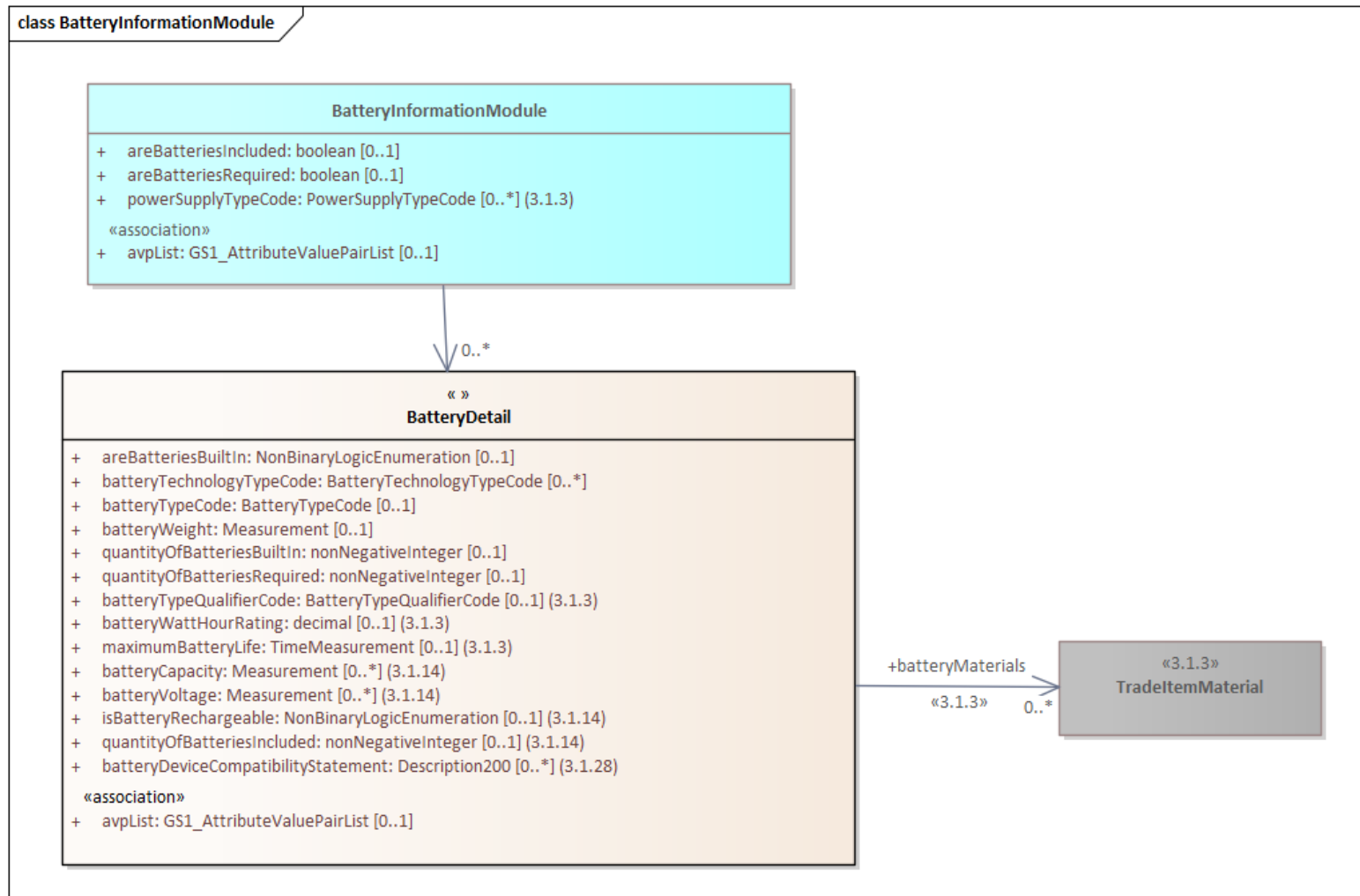

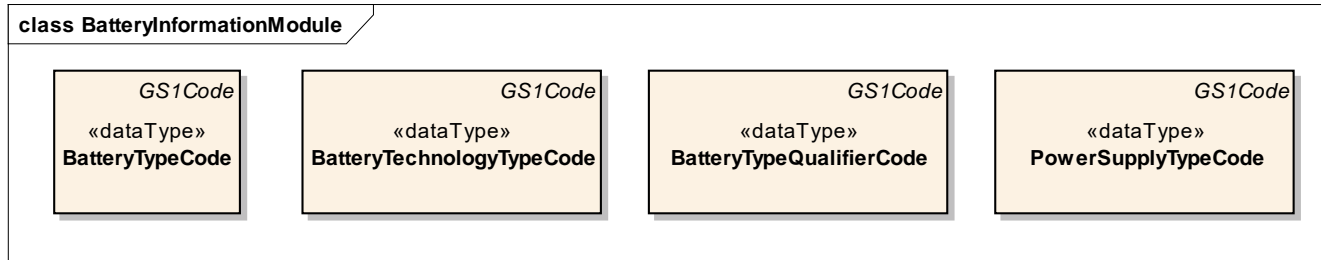

content	attribute / role	datatype /secondary class	multiplcity	definition
BatteryInformationModule				Battery information for a trade item.
Association	avpList	GS1_AttributeValuePairList	0..1	The transmission of non-standard data done in a simple, flexible, and easy to use method.
Association		BatteryDetail	0..*	Battery details for a trade item.
Attribute	areBatteriesIncluded	boolean	0..1	Indicates if batteries are either included or not included with the trade item.
Attribute	areBatteriesRequired	boolean	0..1	Indicates if batteries are required to operate the trade item.
Attribute	powerSupplyTypeCode	PowerSupplyTypeCode	0..*	Indicate the type of power supply the trade item is provided with for example a USB power supply or mains. A power supply is a hardware component that supplies power to an electrical device.
BatteryDetail				Logical grouping of information related to the type of battery required for a trade item.
Association	avpList	GS1_AttributeValuePairList	0..1	The transmission of non-standard data done in a simple, flexible, and easy to use method.
Association	batteryMaterials	TradeItemMaterial	0..*	Battery material information for the item.
Attribute	areBatteriesBuiltIn	NonBinaryLogicEnumeration	0..1	This code is defined as an indicator whether or not any batteries included with the trade item are built into the trade item during manufacturing. and cannot be changed or removed.

content	attribute / role	datatype /secondary class	multiplcity	definition
Attribute	batteryCapacity	Measurement	0..*	The capacity of a battery represents the maximum amount of energy that can be extracted from the battery under certain specified conditions. This capacity is a measure of the charge stored by the battery, and is determined by the mass of active material contained in the battery. Example Ampere per hour, Milliampere per hour, etc.
Attribute	batteryTechnologyTypeCode	BatteryTechnologyTypeCode	0..*	The type of battery family (e.g. Lithium, NiMH) of batteries used by the product.
Attribute	batteryTypeCode	BatteryTypeCode	0..1	The type of battery required to utilize the trade item. For example If "Are Batteries Required" or if "Quantity of Batteries" is populated or if "Are Batteries Included = "Yes" this attribute is recommended so the consumer understands the battery type used in the trade item.
Attribute	batteryDeviceCompatibilityStatement	Description200	0..*	The statement that describes the compatibility of the battery to the type of the device.
Attribute	batteryVoltage	Measurement	0..*	The voltage of a battery is the difference in electric potential between the positive and negative terminals of the battery and is measured in volts.
Attribute	batteryWeight	Measurement	0..1	The weight of each battery included with or built into the trade item.
Attribute	quantityOfBatteriesBuiltIn	nonNegativeInteger	0..1	The quantity of batteries built into the trade item during manufacturing. This includes batteries that can or cannot be changed or removed.
Attribute	quantityOfBatteriesIncluded	nonNegativeInteger	0..1	To identify the number of the specified batteries in the package and/or built in the product.
Attribute	quantityOfBatteriesRequired	nonNegativeInteger	0..1	The number of batteries required to operate the trade item.
Attribute	batteryTypeQualifierCode	BatteryTypeQualifierCode	0..1	Qualifier to denote the rating and material information are in reference to a battery or cell.
Attribute	batteryWattHourRating	decimal	0..1	The watt rating for the specified battery material qualifier as specified by the manufacturer of the item.
Attribute	isBatteryRechargeable	NonBinaryLogic Enumeration	0..1	An indicator to show if the battery can be recharged. A rechargeable battery is a type of battery which can be charged, discharged, and recharged many times.

content	attribute / role	datatype /secondary class	multiplcity	definition
Attribute	maximumBatteryLife	TimeMeasurement	0..1	The maximum capacity of the battery, before it decreases with time and usage. It should be associated to the Battery Type in case a trade item has 2 different types of batteries. The different batteries could have different battery life.

5.11 Certification Information Module

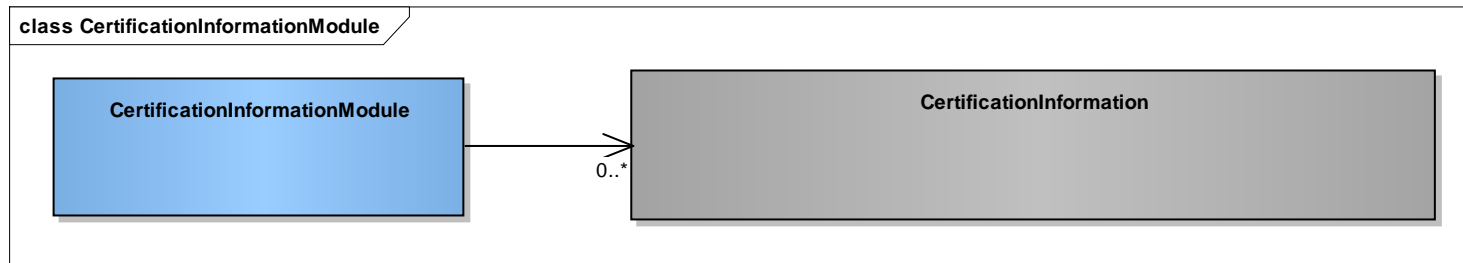

Note: Common class (in grey) is located in the GDSN Common Library.

content	attribute / role	datatype /secondary class	multiplcity	definition
CertificationInformationModule				A module containing information on certification standards to which the trade item, or the process by which it is manufactured, sourced or supplied complies.
Association		CertificationInformation	0..*	Information on certification standards to which the trade item, or the process by which it is manufactured, sourced or supplied complies.



5.12 Chemical Regulation Information Module

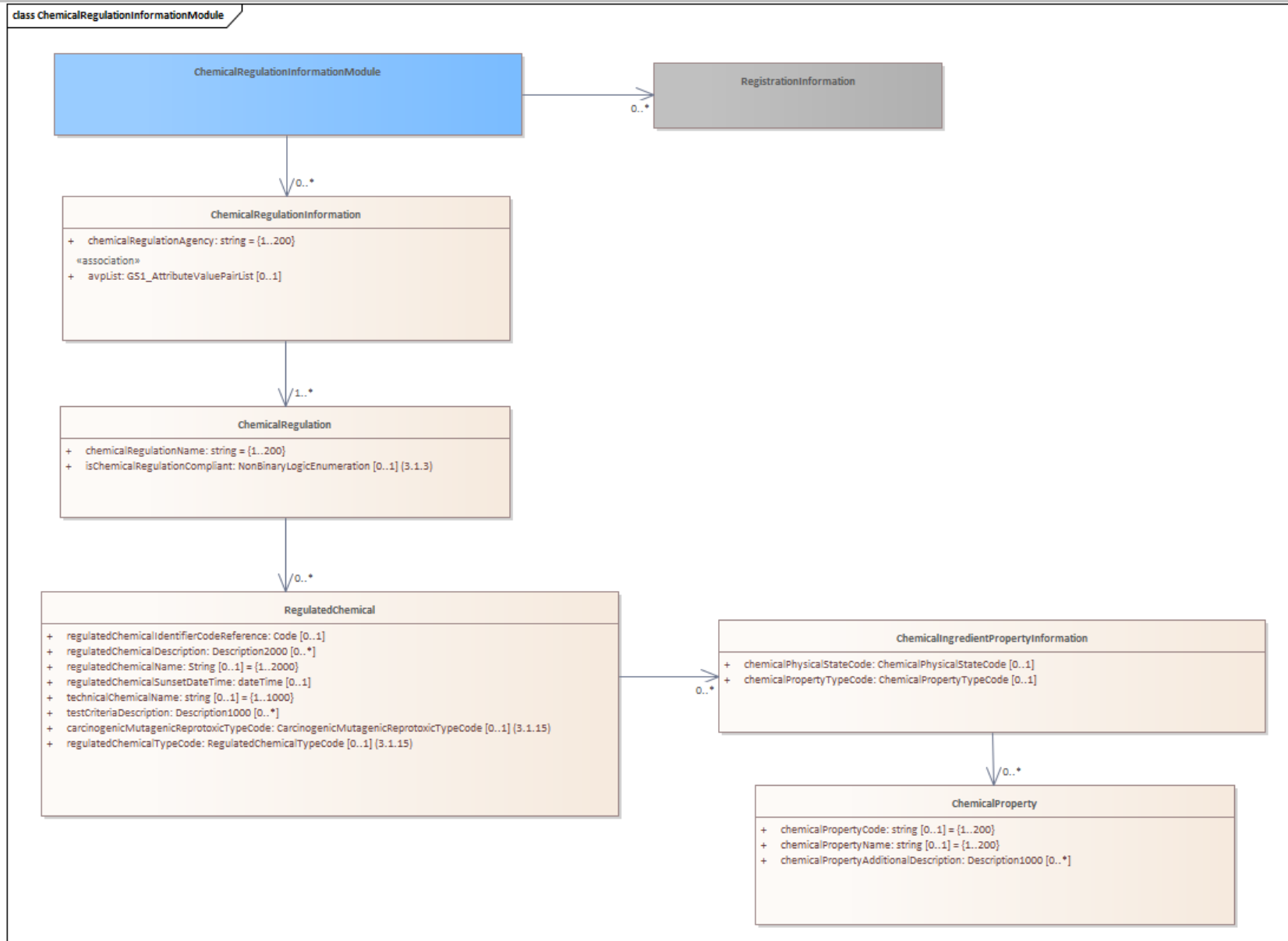

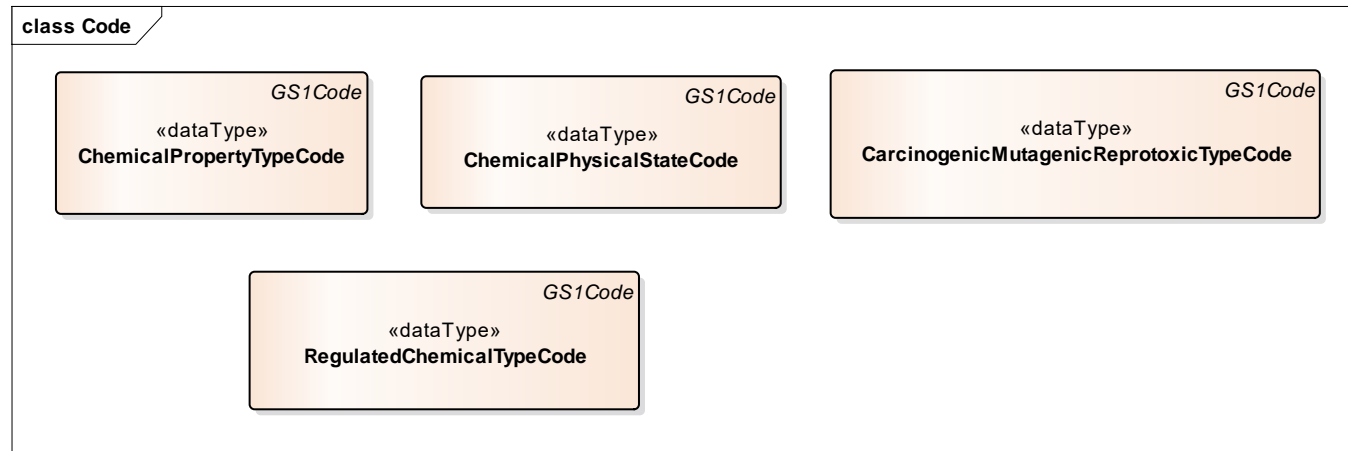

Note: Common class (in grey) is located in the GDSN Common Library.

Content	Attribute / Role	Datatype / Secondary class	Multiplicity	Definition
ChemicalIngredientPropertyInformation				Information on any chemical properties a chemical may have according to a specific regulation for example carcinogen.
Association		ChemicalProperty	0..*	Chemical property information for a regulated chemical.
Attribute	chemicalPhysicalStateCode	ChemicalPhysicalStateCode	0..1	The state of matter of the trade item, for example LIQUID.
Attribute	chemicalPropertyTypeCode	ChemicalPropertyTypeCode	0..1	The type of chemical property being described expressed as a code such as TOXICITY.
ChemicalProperty				A characteristic of a chemical substance for example radionuclide .
Attribute	chemicalPropertyCode	string	0..1	A characteristic of a chemical substance expressed as a code.

Content	Attribute / Role	Datatype / Secondary class	Multiplicity	Definition
Attribute	chemicalPropertyName	string	0..1	A characteristic of a chemical substance expressed as a name for example radionuclide.
Attribute	chemicalPropertyAdditionalDescription	Description1000	0..*	A description of any conditions regarding a toxicity property for example a route of exposure and a target organ (e.g. inhalation and lungs).
ChemicalRegulation				A regulation managed by a regulatory agency to designed to restrict the handling, use, disposal of chemical ingredients for example Right to Know or CERCLA.
Association		RegulatedChemical	0..*	A chemical regulated by a chemical regulation.
Attribute	chemicalRegulationName	string	1..1	The name of a regulation managed by a regulatory agency designed to restrict the handling, use, disposal of chemical ingredients for example Right to Know or CERCLA.
Attribute	isChemicalRegulationCompliant	NonBinaryLogicEnumeration	0..1	Determines whether or not a chemical is compliant with a specific regulation (driven by chemicalRegulationName).
ChemicalRegulationInformation				Provides information on any chemical lists that pertain to the trade item for example CERCLA Priority List.
Association	avpList	GS1_AttributeValuePairList	0..1	The transmission of non-standard data done in a simple, flexible, and easy to use method.
Association		ChemicalRegulation	1..*	A regulation managed by a regulatory agency to designed to restrict the handling, use, disposal of chemical ingredients for example Right to Know or CERCLA.
Attribute	chemicalRegulationAgency	string	1..1	An agency that regulates chemicals for example the US Environmental Protection Agency.
RegulatedChemical				Provides details on any chemical regulated by a chemical regulation.
Association		ChemicalIngredientPropertyInformation	0..*	Provides any required chemical property for example Toxicity.
Attribute	carcinogenicMutagenicReprotoxicTypeCode	CarcinogenicMutagenicReprotoxicTypeCode	0..1	The type of Carcinogenic, mutagenic, reprotoxic (CMR) substance which is contained in the medical device. Examples 1A, 1B

Content	Attribute / Role	Datatype / Secondary class	Multiplicity	Definition
Attribute	regulatedChemicalIdentifierCodeReference	Code	0..1	An identifier for a regulated chemical for example a CAS number.
Attribute	regulatedChemicalDescription	Description2000	0..*	A text description of the regulated chemical or formula.
Attribute	regulatedChemicalName	string	0..1	The name of a chemical regulated by a chemical regulation or agency. For example Chlorobenzene.
Attribute	regulatedChemicalSunsetDateTime	dateTime	0..1	As the date from which the placing on the market and the use of a substance is prohibited or restricted.
Attribute	regulatedChemicalTypeCode	RegulatedChemicalType Code	0..1	The type of regulated chemical as defined by the regulatory agency. Example Endocrine Substance, Human Product, Medicine Product.
Attribute	technicalChemicalName	string	0..1	The official technical name for a chemical as required by a managing agency for example mercuric chloride.
Attribute	testCriteriaDescription	Description1000	0..*	A description of any the criteria or test data being used to determine if a regulated chemical for example "Subject to Acute toxicity tests".
ChemicalRegulationInformationModule				A module containing information on any chemical properties a chemical may have according to a specific regulation for example carcinogen.
Association		RegistrationInformation	0..*	Registration information for a chemical or substance for example a pesticide.
Association		ChemicalRegulationInformation	0..*	Information on any chemical properties a chemical may have according to a specific regulation for example carcinogen.

5.13 Child Nutrition Information Module

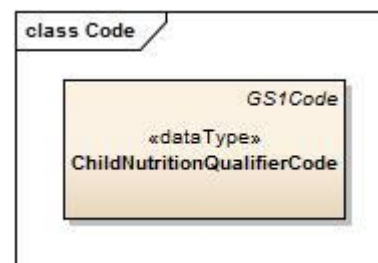
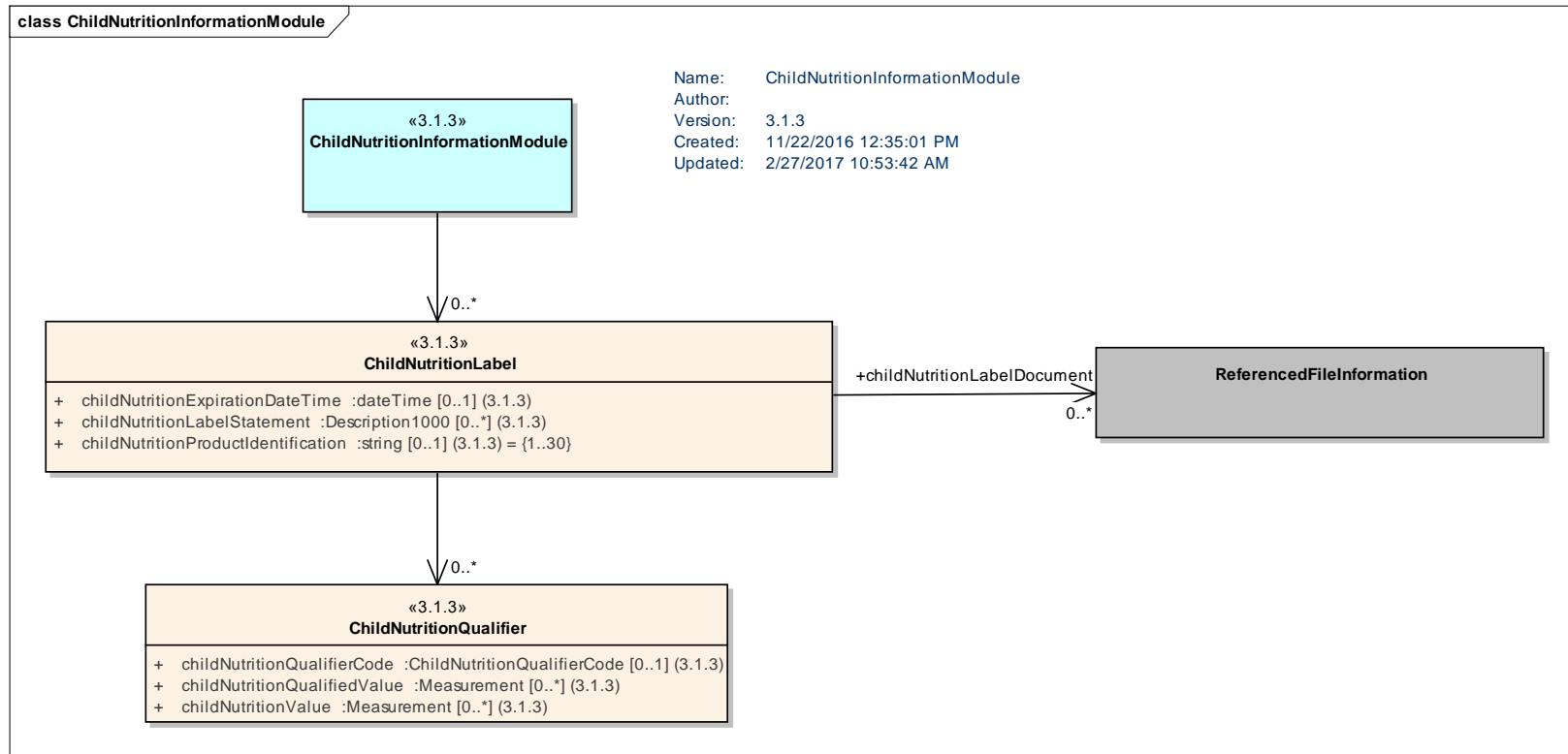

content	attribute / role	datatype /secondary class	multiplicity	definition
ChildNutritionInformationModule				A module providing details on child nutrition.
Association		ChildNutritionLabel	0..*	Child nutrition label information for a trade item.
ChildNutritionLabel				Information provided about the item based on target market regulations and rules to provide specific nutrition equivalent values for child nutrition.
attribute	childNutritionExpirationDateTime	dateTime	0..1	The date upon which the child nutrition statement or label expires.
attribute	childNutritionLabelStatement	Description1000	0..*	The text of the Child Nutrition Label as specified by the child nutrition product identification agency.
attribute	childNutritionProductIdentification	string	0..1	A child nutrition identification number of the child nutrition statement or label as provided by or through the authority of the child nutrition product identification agency.
Association	childNutritionLabelDocument	ReferencedFileInformation	0..*	A link to a copy of the Child Nutrition Label.
Association		ChildNutritionQualifier	0..*	Nutritional qualifiers for a child nutrition label.
ChildNutritionQualifier				A class of attributes which provide definition of the child nutrition types and values represented in the child nutrition label for the item.
attribute	childNutritionQualifierCode	ChildNutritionQualifierCode	0..1	A qualifier to specify the type of equivalent measurement that is applicable to the item as specified in the child nutrition statement or label. Example: FRUIT_VEGETABLE_OR_FRUIT_VEGETABLE_ALTERNATIVE.
attribute	childNutritionQualifiedValue	Measurement	0..*	Reference or qualified value for the child nutrition value as specified in the child nutrition statement or label. For example, if a 4.5 ounce serving provides 1/8 cup red-orange vegetable, the childNutritionQualifiedValue is 4.5 ounces.
attribute	childNutritionValue	Measurement	0..*	Actual value for the child nutrition qualifier as specified in the child nutrition statement or label. For example, if a 4.5 ounce serving provides 1/8 cup red-orange vegetable, the childNutritionValue is 1/8 cup.

5.14 Consumer Instructions Module

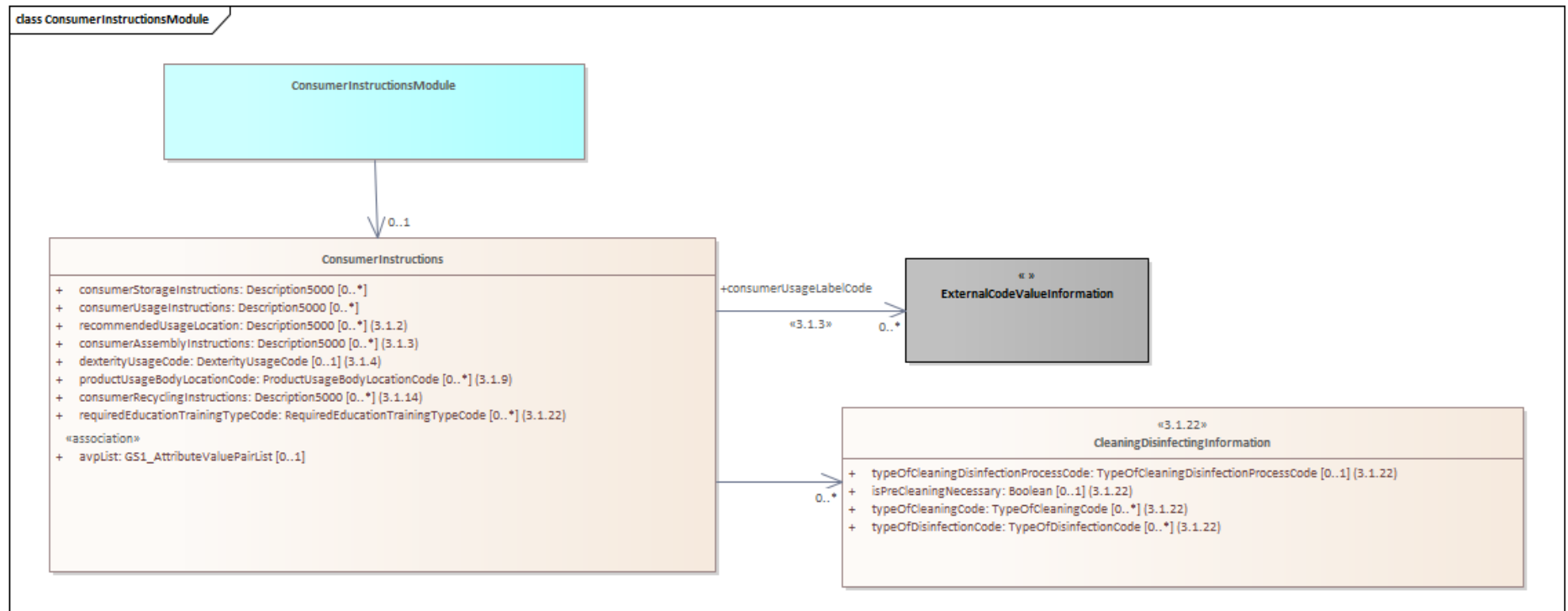



content	attribute / role	datatype /secondary class	multiplcity	definition
ConsumerInstructionsModule				A module contain instructions on how the consumer is to use or store a trade item.
Association		ConsumerInstructions	0..1	Instructions on how the consumer is to use or store a trade item.
ConsumerInstructions				Instructions on how the consumer is to use or store a trade item.
Attribute	consumerAssemblyInstructions	Description5000	0..*	The instructions on how to assemble the trade item.
Attribute	consumerRecyclingInstructions	Description5000	0..*	Expresses in text the consumer recycling instructions which are normally held on the label or accompanying the product. Instructions may refer to the "how" the consumer is supposed to sort the product and packaging materials for recycling.
Attribute	consumerStorageInstructions	Description5000	0..*	Expresses in text the consumer storage instructions of a product which are normally held on the label or accompanying the product. This information may or may not be labeled on the pack. Instructions may refer to a suggested storage temperature, a specific storage requirement.

content	attribute / role	datatype /secondary class	multiplcity	definition
Attribute	consumerUsageInstr uctions	Description5000	0..*	Expresses in text the consumer usage instructions of a product which are normally held on the label or accompanying the product. This information may or may not be labeled on the pack. Instructions may refer to a the how the consumer is to use the product, This does not include storage, food preparations, and drug dosage and preparation instructions.
Attribute	dexterityUsageCode	DexterityUsageCod e	0..1	A code describing the type of handedness the trade item is designed to be used for example LEFT_HANDED, RIGHT_HANDED, etc.
Attribute	productUsageBodyLo cationCode	ProductUsageBody LocationCode	0..*	Indicates the body location for which the product is intended to be used for example HAND.
Attribute	recommendedUsagel ocation	Description5000	0..*	The primary location recommended for the item's use for example indoor, outdoor, indoor/outdoor, vehicle, kitchen, etc.
Attribute	requiredEducationTra iningTypeCode	RequiredEducation TrainingTypeCode	0..*	The code that describes the appropriate type of education or training required to use/handle/operate the product.
Association	consumerUsageLabel Code	ExternalCodeValue Information	0..*	A code representation of the consumer usage information represented via a label.
Association	avpList	GS1_AttributeValu ePairList	0..1	The transmission of non-standard data done in a simple, flexible, and easy to use method.
CleaningDisinfecti ngInformation				A group of attributes to help the buyer understand the cleaning and/or disinfecting of a product.
Attribute	isPreCleaningNecessa ry	Boolean	0..1	The indicator that specifies whether pre-cleaning of the product is required before cleaning and disinfection.
Attribute	typeOfCleaningCode	TypeOfCleaningCo de	0..*	The code that describes the form of cleaning/detergent that can be used for the product. Example: Cleaning/detergent in accordance with ISO 15883.
Attribute	typeOfCleaningDisinf ectionProcessCode	TypeOfCleaningDisi nfectionProcessCod e	0..1	The code that describes the type of process necessary to clean or disinfect the specific product.
Attribute	typeOfDisinfectionCo de	TypeOfDisinfection Code	0..*	The code that describes the type of disinfection that is possible for the product. Example: Disinfection type in accordance with ISO 15883.

5.15 Controlled Substances Module

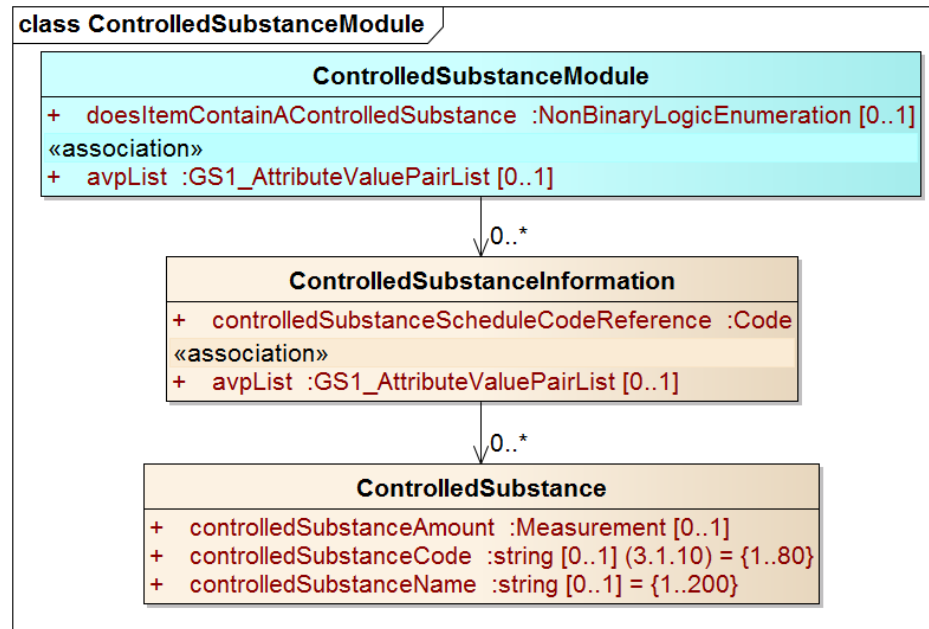

Content	Attribute / Role	Datatype /Secondary class	Multiplcity	Definition
ControlledSubstance				Information on the containment of controlled substances
Attribute	controlledSubstanceAmount	Measurement	0..1	The numeric amount of a specific substance the item contains that is regulated under law as narcotics, stimulants, depressants, hallucinogens, anabolic steroids, and chemicals used in the illicit production of controlled substances
Attribute	controlledSubstanceCode	string	0..1	A code identifying the specific substance the item contains that is regulated under law as narcotics, stimulants, depressants, hallucinogens, anabolic steroids, and chemicals used in the illicit production of controlled substances
Attribute	controlledSubstanceName	string	0..1	The name of a specific substance the item contains that is regulated under law as narcotics, stimulants, depressants, hallucinogens, anabolic steroids, and chemicals used in the illicit production of controlled substances

Content	Attribute / Role	Datatype / Secondary class	Multiplcity	Definition
ControlledSubstance Information				Information on controlled substances based upon the degree of the substance's medicinal value, harmfulness, and potential for abuse or addiction.
Association		ControlledSubstance	0..*	Information on the containment of controlled substances.
Attribute	controlledSubstanceScheduleCodeReference	Code	1..1	A code that rates a controlled substance based upon the degree of the substance's medicinal value, harmfulness, and potential for abuse or addiction
Association	avpList	GS1_AttributeValuePairList	0..1	The transmission of non-standard data done in a simple, flexible, and easy to use method.
ControlledSubstance Module				Information on the containment of controlled substances.
Association	avpList	GS1_AttributeValuePairList	0..1	The transmission of non-standard data done in a simple, flexible, and easy to use method.
Association		ControlledSubstance Information	0..*	Controlled Substance Information for a trade item.
Attribute	doesItemContainAControlledSubstance	NonBinaryLogicEnumeration	0..1	Indicates whether the item contains substances that are regulated under law as narcotics, stimulants, depressants, hallucinogens, anabolic steroids, and chemicals used in the illicit production of controlled substances

5.16 Copyright Information Module

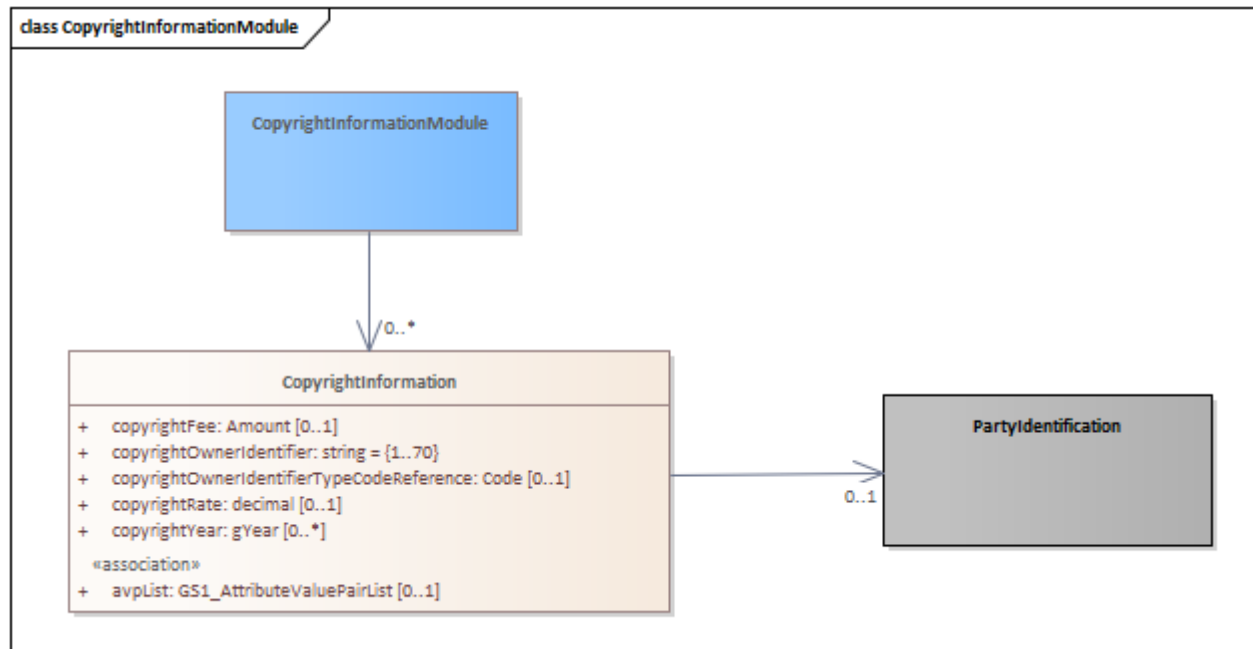

Content	Attribute / Role	Datatype / Secondary class	Multiplicity	Definition
CopyrightInformation				A group of data elements which together represent a copyright statement for the product.
Association	avpList	GS1_AttributeValuePairList	0..1	The transmission of non-standard data done in a simple, flexible, and easy to use method.
Association		PartyIdentification	0..1	GS1 Party Identification for a Publication Copyright
Attribute	copyrightFee	Amount	0..1	A fee paid to the content owner for use of the Trade Item or an associated part of the Trade Item.
Attribute	copyrightOwnerIdentifierTypeCodeReference	Code	0..1	Identifies the scheme from which the value in the copyrightOwnerIdentifier attribute is taken.



Content	Attribute / Role	Datatype /Secondary class	Multipl icity	Definition
Attribute	copyrightOwnerIdentifier	string	1..1	An identifier of the owner of the copyright on a trade item. This could be the person who creates a piece of work though it may also be a company that pays a person to create a work.
Attribute	copyrightRate	decimal	0..1	A rate paid to the content owner for use of the trade item or an associated part of the trade item.
Attribute	copyrightYear	gYear	0..*	The copyright year as it appears in a copyright statement on the product.
CopyrightInformationModule				A group of data elements which together represent a copyright statement for the product.
Association		CopyrightInformation	0..*	A group of data elements which together represent a copyright statement for the product.

5.17 Dairy Fish Meat Poultry Item Module

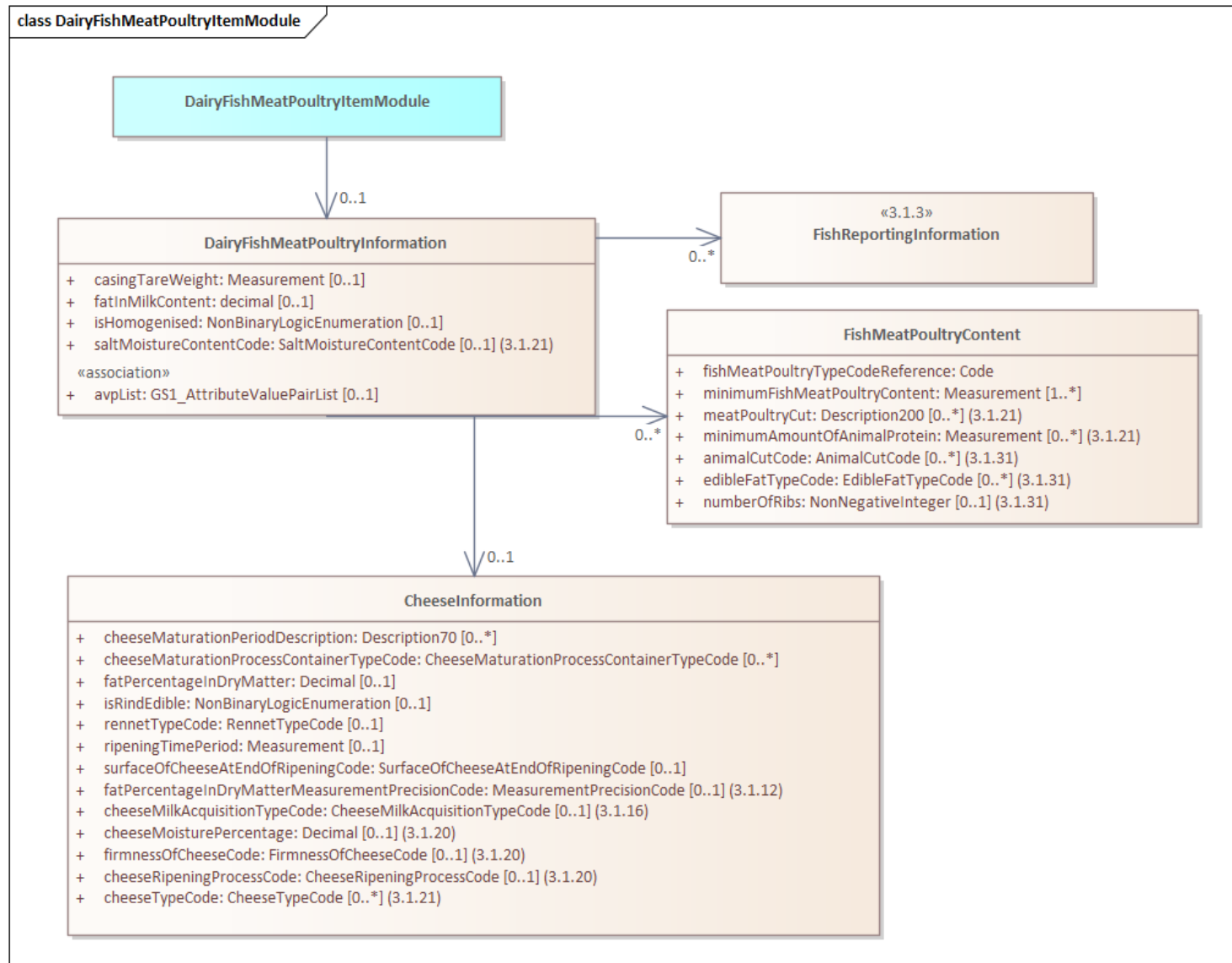

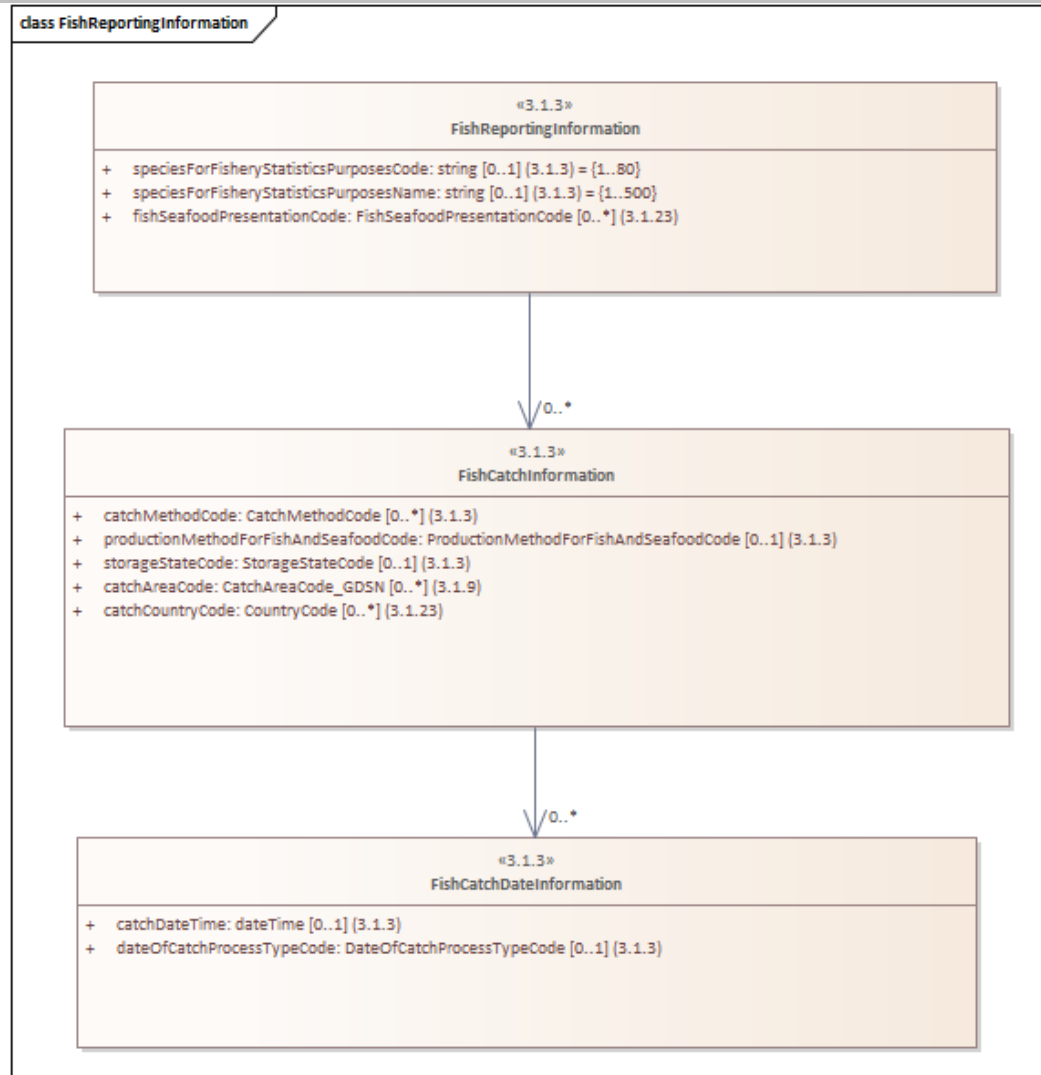

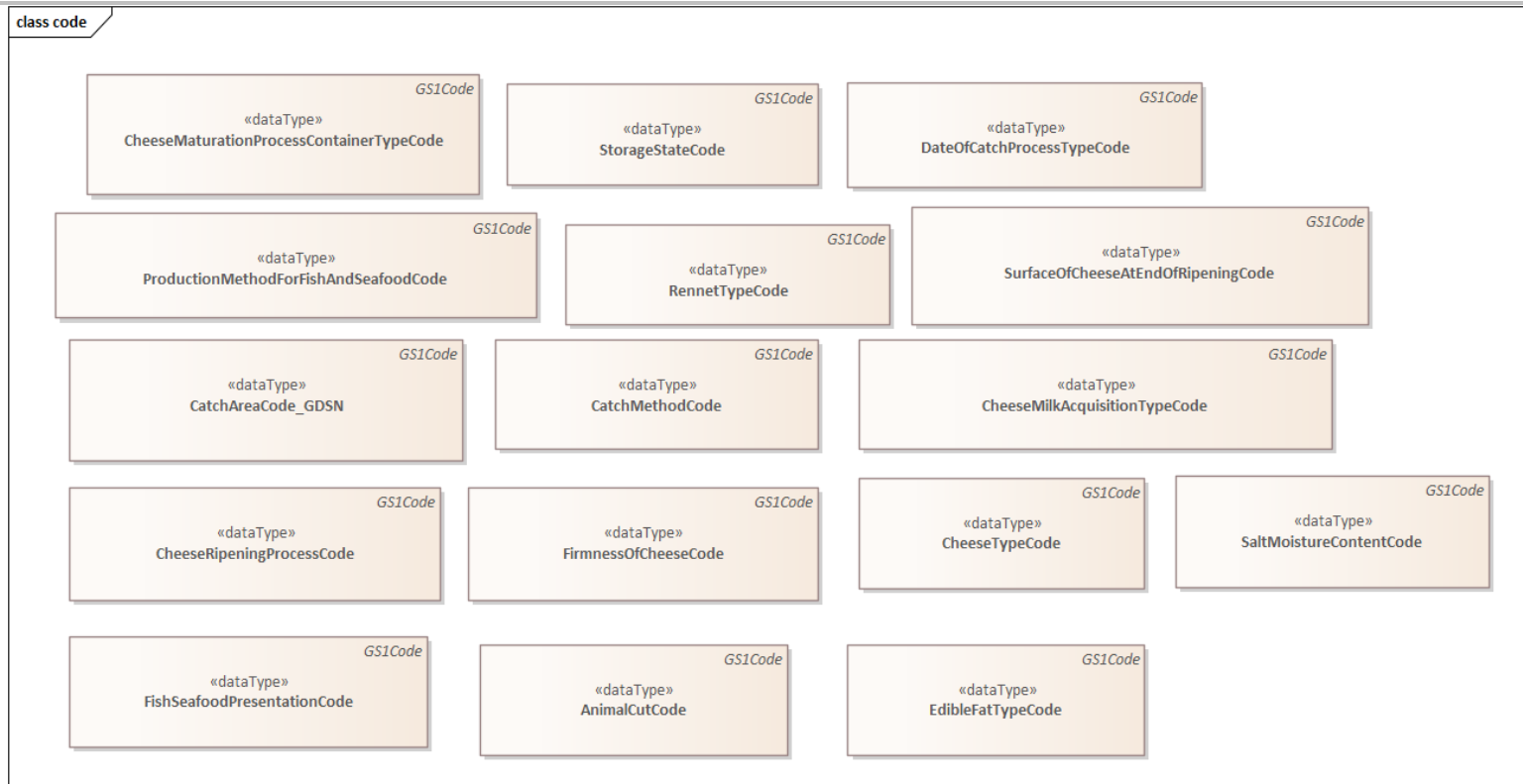

Content	Attribute / Role	Datatype /Secondary class	Multiplicity	Definition
DairyFishMeatPoultryItemModule				Content and processing related information specific to dairy, fish, meat and poultry products.
Association		DairyFishMeatPoultryInformation	0..1	Content and processing related information specific to dairy, fish, meat and poultry products.
CheeseInformation				Trade Item information related to Cheese

Content	Attribute / Role	Datatype /Secondary class	Multiplicity	Definition
Attribute	cheeseMaturationPeriodDescription	Description70	0..*	A descriptive way to specify a date range as some cheeses are matured over a period of time, but not an exact period. For example 3 to 4 weeks, over 1 year etc. The term maturation is also known in other markets as Aged.
Attribute	cheeseMaturationProcessContainerTypeCode	CheeseMaturationProcessContainerTypeCode,	0..*	The type of container that the process of maturation cheese occurs in. The container directly influences the flavour of the cheese. The term maturation is also know in other markets as Aged.
Attribute	cheeseMilkAcquisitionTypeCode	CheeseMilkAcquisitionTypeCode	0..1	Allows you to indicate the type of legal mention on the packaging of the acquisition type of the milk for cheese . Example: Farm.
Attribute	cheeseMoisturePercentage	Decimal	0..1	The amount of moisture content in cheese products.
Attribute	cheeseRipeningProcessCode	CheeseRipeningProcessCode	0..1	The code indicating the ripening process within the body of the cheese. The determination of this is made by the supplier and may be subject to target market regulations or trade organization guidelines.
Attribute	cheeseTypeCode	CheeseTypeCode	0..*	The code identifying a specific type of cheese
Attribute	fatPercentageInDryMatter	Decimal	0..1	The amount of fat contained in the base product expressed in percentage.
Attribute	firmnessOfCheeseCode	FirmnessOfCheeseCode	0..1	The code indicating the relative firmness of the cheese based on moisture content. The determination of this is made by the supplier and may be subject to target market regulations or trade organization guidelines.
Attribute	isRindEdible	NonBinaryLogicEnumeration	0..1	An indicator whether or not the cheese rind is edible. Some cheeses are coated in plastic or their surface is treated with other traditional substances to increase their shelf life. This can result in the rind no longer being edible.
Attribute	rennetTypeCode	RennetTypeCode	0..1	The type of rennet used for coagulation. The enzyme rennet is used for the coagulation of the cheese mass. Rennet and respectively similar enzymes can be gained through various processes.
Attribute	ripeningTimePeriod	Measurement	0..1	The period of time for ripening the cheese. During ripening the aroma and consistency of a cheese constantly changes. The character of a cheese is thus strongly determined by the period of ripening. Depending on personal preference, the end consumer prefers either a "young" or a "mature" cheese.

Content	Attribute / Role	Datatype /Secondary class	Multiplicity	Definition
Attribute	surfaceOfCheeseAtEndOfRipeningCode	surfaceOfCheeseAtEndOfRipeningCode	0..1	The representation of whether or not a cheese contains a rind at the end of the maturing process. A Rind is the outside shell of cheese that forms during the cheese making process. Rinds are natural and usually edible, as opposed to other coverings, such as wax and cloth, that are inedible.
Attribute	fatPercentageInDryMatterMeasurementPrecisionCode	MeasurementPrecisionCode	0..1	A code qualifying the percentage of fat in dry matter, for example LESS_THAN
DairyFishMeatPoultryInformation				Content and processing related information specific to dairy, fish, meat and poultry products.
Attribute	fatInMilkContent	Decimal	0..1	The percentage of fat contained in milk content of the product.
Attribute	isHomogenised	NonBinaryLogicEnumeration	0..1	The indication whether or not the milk used was actively homogenised. The homogenisation of milk is a technical process in the dairy. The milk fat is milled to such an extent that further creaming is prevented.
Attribute	casingTareWeight	Measurement	0..1	The weight measurement of the "food casing". A casing for food products is a flexible tubing into which foods are stuffed to provide a skin-tight covering. Used in packaging prepared meats, poultry, cheese, and other food products. Casings may be made of animal intestines or synthetic materials such as regenerated cellulose, various plastics, fibrous compounds, and rubber film. "Tare Weight - food casing" applies to the "each" level.
Attribute	saltMoistureContentCode	SaltMoistureContentCode	0..1	The code indicating the salt and moisture content of the product by using the appropriate expression. The determination of this is made by the supplier and may be subject to target market regulations or trade organization guidelines.
Association		CheeseInformation	0..1	Information specific to cheese trade items.
Association		FishMeatPoultryContent	0..*	Content and processing related information specific to fish, meat and poultry products.
Association		FishReportingInformation	0..*	Fish reporting information for a trade item.
Association	avpList	GS1_AttributeValuePairList	0..1	The transmission of non-standard data done in a simple, flexible, and easy to use method.
FishMeatPoultryContent				Fish, meat and poultry content of a food and beverage trade item.

Content	Attribute / Role	Datatype /Secondary class	Multiplicity	Definition
Attribute	fishMeatPoultryTypeCodeReference	Code	1..1	The fish, meat, or poultry type for this food and beverage item.
Attribute	minimumFishMeatPoultryContent	Measurement	1..*	The minimum amount of fish, meat or poultry contained in a food and beverage trade item expressed as a measurement.
Attribute	meatPoultryCut	Description200	0..*	The description of a piece of meat that has been cut from an animal carcass. The determination of this is made by the supplier and is subject to target market regulations or trade organization guidelines.
Attribute	minimumAmountOfAnimalProtein	Measurement	0..*	Indicate the minimum amount of animal meat (or poultry) protein contained in the product. The determination of this is made by the supplier and may be subject to target market regulations or trade organization guidelines.
Attribute	animalCutCode	AnimalCutCode	0..*	The code indicating the cut(s), process and/or part of the animal included or excluded that the trade item contains.
Attribute	numberOfRibs	NonNegativeInteger	0..1	The number of ribs that the trade item has.
Attribute	edibleFatTypeCode	EdibleFatTypeCode	0..*	The code indicating the fat type the trade item contains.
FishCatchInformation				Details on the catch of a fish.
attribute	catchMethodCode	CatchMethodCode	0..*	The code indicating what type of fishing gear was used to catch fish and seafood.
attribute	productionMethodForFishAndSeafoodCode	ProductionMethodForFishAndSeafoodCode	0..1	The code indicating how the fish and seafood were grown and harvested or caught.
attribute	storageStateCode	StorageStateCode	0..1	A code depicting that the referred product was previously frozen or not.
Attribute	catchAreaCode	CatchAreaCode_GDSN	0..*	The sea zone in which the seafood in the trade item was caught.
Attribute	catchCountryCode	CountryCode	0..*	The ISO 3166-1 numeric code for the country where the fish/seafood in the product was caught or farmed.
association		FishCatchDateInformation	0..*	Information in regards to the catch date for a fish or seafood product.
FishCatchDateInformation				Information in regards to the catch date for a fish or seafood product.
Attribute	catchDateTime	dateTime	0..1	The date of the catch within the EDI and/or Information at the label distributed with the product for information of any single lot of

Content	Attribute / Role	Datatype /Secondary class	Multiplicity	Definition
				fresh fish and seafood product. Format (YYYYMMDD) as a specification with time stamp is not required in the current EU Regulation. This required attribute will help the global retail industry to fulfill the EU requirements for a common fisheries policy. The data is required by the supply chain participant from source to end consumer.
Attribute	dateOfCatchProcessTypeCode	DateOfCatchProcessTypeCode	0..1	The process of how the fish is dated, for example REAL_TIME as fish are caught they are dated and time stamped like tuna, ONE_TIME_CATCH on a date for fish farming, or PERIODIC_CATCH meaning the catch date reflective of seasonal catch like lobster trapping.
FishReportingInformation				Information related to FAO reporting for fish.
Association		FishCatchInformation	0..*	Details related to a fish catch for a trade item.
Attribute	speciesForFisheryStatisticsPurposesCode	string	0..1	The FAO 3 Alpha code of the species of fish for fish and seafood.
Attribute	speciesForFisheryStatisticsPurposesName	string	0..1	The scientific name associated with the speciesforFisheryStatisticsPurposesCode.
Attribute	fishSeafoodPresentationCode	FishSeafoodPresentationCode	0..*	The code that indicates the state or form of a fish/seafood product as presented to the consumer, possibly as a result of post-catch processing (e.g., tail removed, gutted, or filleted).

5.18 Dangerous Substance Information Module

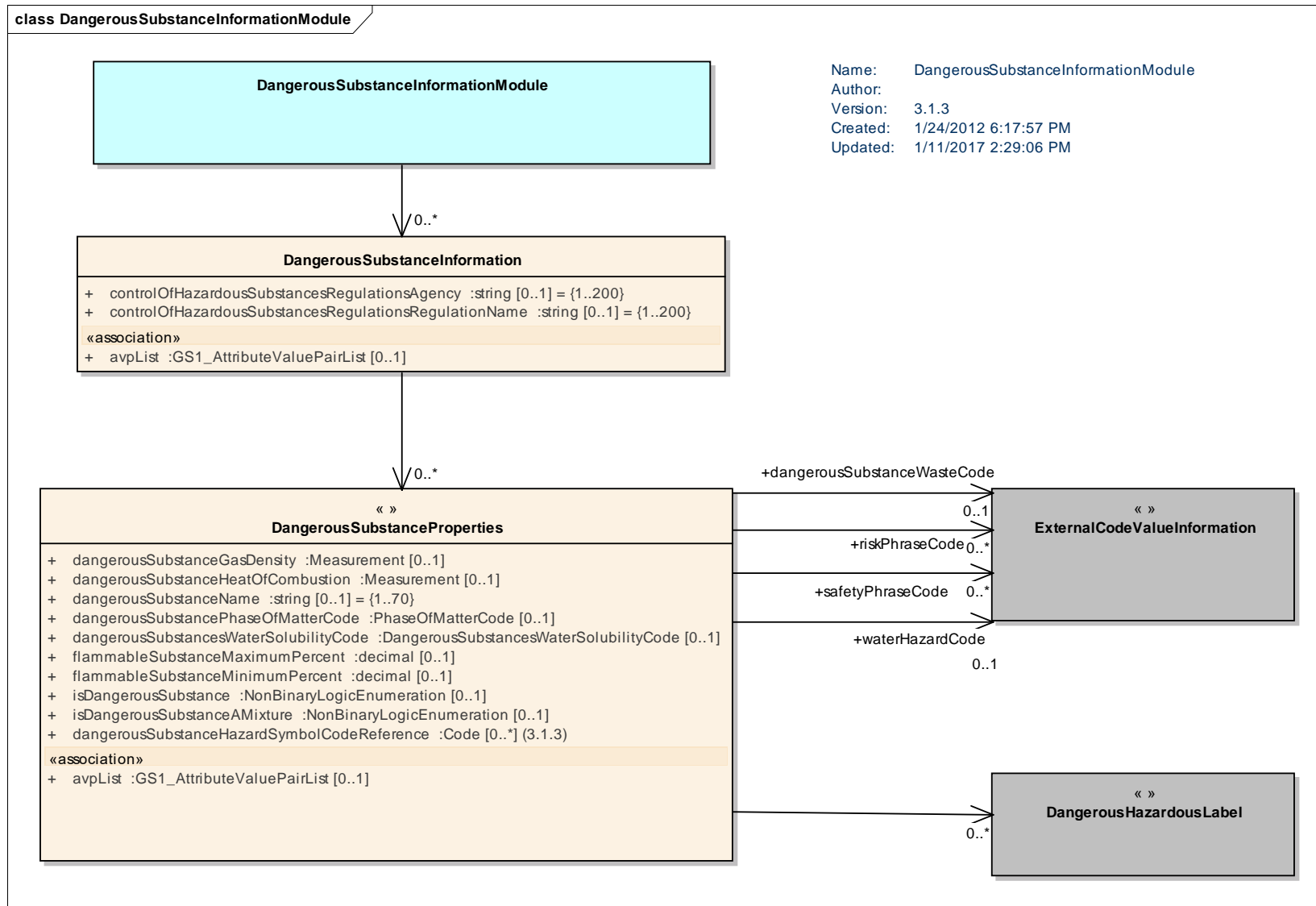

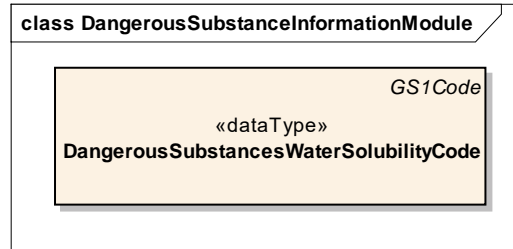

 **Note:** Common class (in grey) is located in the GDSN Common Library.

Content	Attribute / Role	Datatype / Secondary class	Multiplicity	Definition
DangerousSubstanceInformationModule				A module detailing substances that can harm people, other living organisms, property, or the environment.
Association		DangerousSubstanceInformation	0..*	Details on substances that can harm people, other living organisms, property, or the environment.
DangerousSubstanceInformation				Details on substances that can harm people, other living organisms, property, or the environment.
Association		DangerousSubstanceProperties	0..*	Properties of a dangerous substance.
Attribute	controlOfHazardousSubstancesRegulationsAgency	string	0..1	The government or agency that owns regulation controlling hazard substances that may apply to the product.
Attribute	controlOfHazardousSubstancesRegulationsRegulationName	string	0..1	The name of the regulation controlling hazard substances that may apply to the product.
DangerousSubstanceProperties				Details on substances that can harm people, other living organisms, property, or the environment.
Association		GS1_AttributeValuePairList	0..1	Attribute value pair information.
Association		DangerousHazardousLabel	0..*	Information on visible labels on packaging indicating specific risks and required precautions associated with a dangerous/hazardous good.
Association	dangerousSubstanceWasteCode	ExternalCodeValueInformation	0..1	The dangerous substances waste code used to identify the substance's dangerous waste for example the European Waste Catalogue.

Content	Attribute / Role	Datatype / Secondary class	Multiplcity	Definition
Association	riskPhraseCode	ExternalCodeValueInformation	0..*	The abbreviation codes for labelling obligations and special risks (health risks of skin, respiratory organs, swallow, eyes, reproduction) for handling of the substance.
Association	safetyPhraseCode	ExternalCodeValueInformation	0..*	Safety phrases are defined as safety advice concerning dangerous substances and preparations defined in Annex 3 for example (S1): Keep locked up or S12: Do not keep the container sealed.
Association	waterHazardCode	ExternalCodeValueInformation	0..1	A code determining the degree to which the product would pose an environmental hazard to water.
Attribute	dangerousSubstance GasDensity	Measurement	0..1	The density of gas contained within the trade item. This can be used by the data receiver to determine the total stored amounts of gas within a storage facility in accordance with dangerous substance regulations. Use appropriate measurement for example in Europe (grams per Cubic Centimetre).
Attribute	dangerousSubstance HeatOfCombustion	Measurement	0..1	The amount of heat generated by the item should it catch on fire expressed as amount of energy per pound for example BTU's (British Thermal Units) per pound.
Attribute	dangerousSubstance Name	string	0..1	The name of the type of dangerous substance contained in the trade item for example Butane.
Attribute	dangerousSubstance PhaseOfMatterCode	PhaseOfMatterCode	0..1	A set of qualitatively different states, depending on temperature and pressure related physical properties. They are divided into solid, liquid,gaseous and mixed forms of the substance.
Attribute	dangerousSubstance sWaterSolubilityCode	DangerousSubstance sWaterSolubilityCode	0..1	A code indicating the solubility or miscibility in respect with water. Solubility is the ability of a given substance to dissolve in a solvent. Miscibility is the property of liquids to mix in all proportions, forming a homogeneous solution.
Attribute	flammableSubstance MaximumPercent	decimal	0..1	The maximum percentage of the flammable substance contained in the trade item. This can be used by the data receiver to support determining total stored amounts within a storage facility in accordance with dangerous substance regulations.

Content	Attribute / Role	Datatype /Secondary class	Multiplcity	Definition
Attribute	flammableSubstanceMinimumPercent	decimal	0..1	The minimum percentage of the flammable substance contained in the trade item. This can be used by the data receiver to support determining total stored amounts within a storage facility in accordance with dangerous substance regulations.
Attribute	isDangerousSubstance	NonBinaryLogicEnumeration	0..1	An indicator whether or not a trade item is classified and labelled as containing a dangerous substance.
Attribute	isDangerousSubstanceAMixture	NonBinaryLogicEnumeration	0..1	An indicator whether or not the dangerous substance is a mixture of several substances.
Attribute	dangerousSubstanceHazardSymbolCodeReference	Code	0..*	A code representation of the dangerous or hazardous symbol contained on a trade item.
Association	avpList	GS1_AttributeValuePairList	0..1	The transmission of non-standard data done in a simple, flexible, and easy to use method.

5.19 Delivery Purchasing Information Module

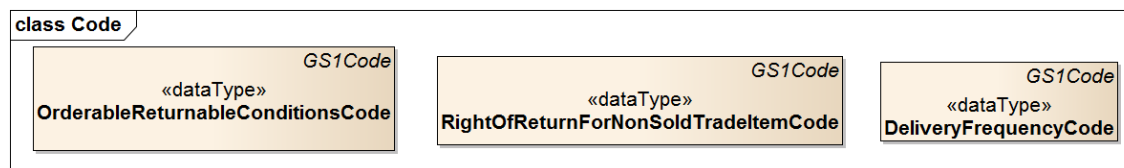
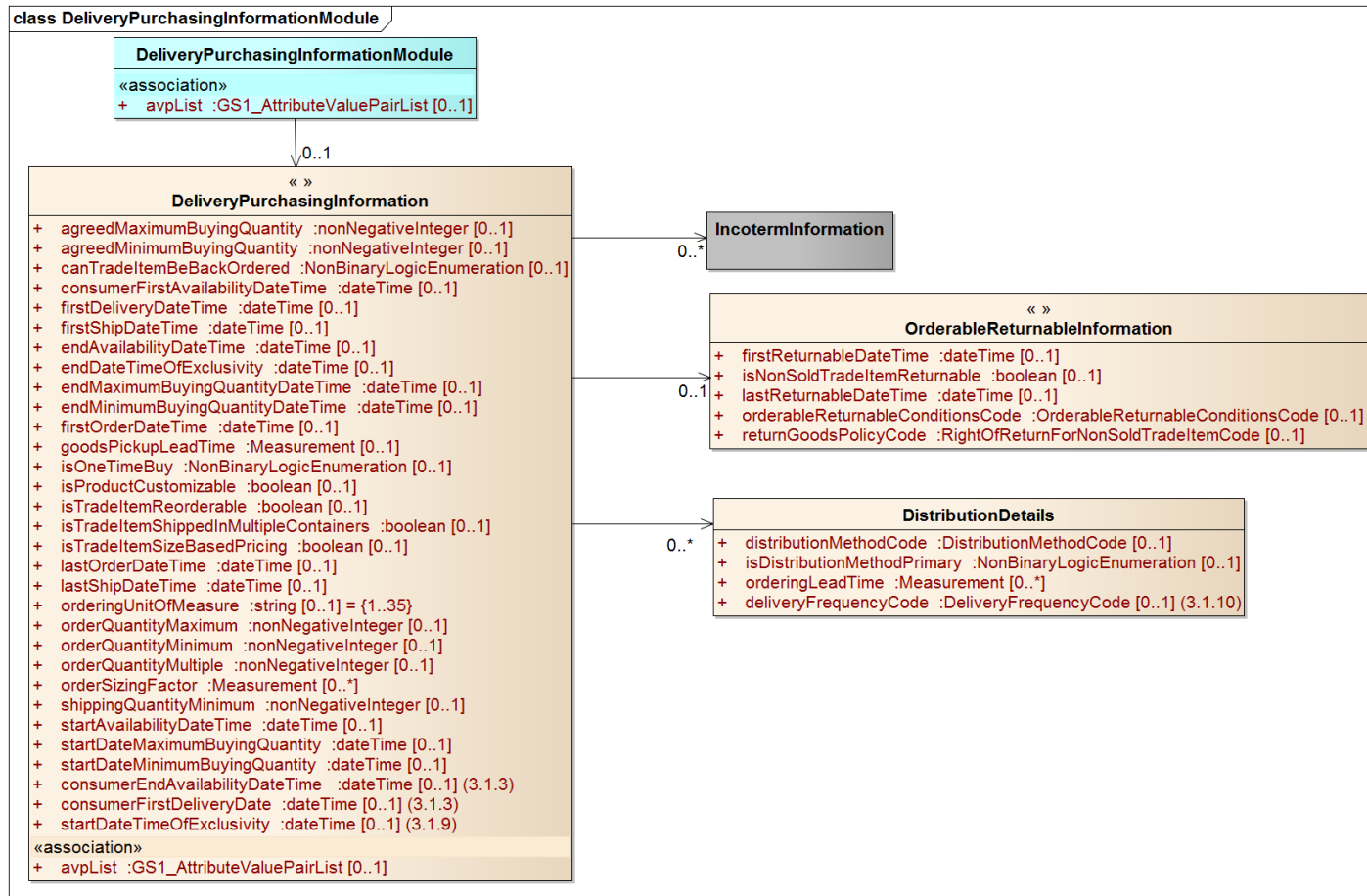

 **Note:** Common class (in grey) is located in the GDSN Common Library.

content	attribute / role	datatype /secondary class	multiplicity	definition
OrderableReturnableInformation				Logical Grouping of Orderable Returnable Information
Attribute	firstReturnableDate	dateTime	0..1	The first date on or after which non-sold trade items can be returned. This information provides the retailer with any conditions required by the information provider as to the date on or after which non-sold trade items may be returned in order to receive credit from the appropriate party.
Attribute	isNonSoldTradeItemReturnable	boolean	0..1	Indicates that the buyer can return the articles that are not sold. Used, for example; with magazines and bread. This is a y/n (Boolean) where y equals right of return. This is at least relevant to General Merchandise, Publishing industries and for some FMCG trade item.
Attribute	lastReturnableDate	dateTime	0..1	The last date and time when a non sold trade item must be received by the manufacturer to receive credit.
Attribute	orderableReturnableConditionsCode	OrderableReturnableConditionsCode	0..1	A code that indicates if the trade item can be ordered and returned if non-sold.
Attribute	returnGoodsPolicyCode	RightofReturnForNonSoldTradeItemCode	0..1	A code that describes the policy for defective, damaged or non-salable goods.
DistributionDetails				Delivery details for a trade item.
Attribute	distributionMethodCode	DistributionMethodCode	0..1	The code value that indicates the method of delivery for the trade item.
Attribute	isDistributionMethodPrimary	NonbinaryLogicEnumeration	0..1	Indicates if the delivery method for the trade item is the primary one.
Attribute	orderingLeadTime	Measurement	0..*	Lead time required for orders expressed in days.
DeliveryPurchasingInformation				Purchasing and delivery information for a trade item.
Attribute	deliveryFrequencyCode	DeliveryFrequencyCode	0..1	A code specifying the regular delivery frequency for a specific product or service.
Association		DistributionDetails	0..*	Delivery details for a trade item.
Association		OrderableReturnableInformation	0..1	Orderable and returnable information.

content	attribute / role	datatype /secondary class	multiplicity	definition
Association		IncotermInformation	0..*	Information on any incoterms that are applicable to the trade item.
Attribute	agreedMaximumBuyingQuantity	nonNegativeInteger	0..1	The maximum quantity of the product available to the retailer.
Attribute	agreedMinimumBuyingQuantity	nonNegativeInteger	0..1	Minimum buying quantity agreed between trading partners.
Attribute	canTradeItemBeBackOrdered	NonBinaryLogicEnumeration	0..1	An indicator whether or not a customer's order will be processed or will remain valid when it cannot be filled due to insufficient stock.
Attribute	consumerFirstAvailabilityDateTime	dateTime	0..1	The first date/time that the buyer is allowed to sell the trade item to consumers. Usually related to a specific geography. ISO 8601 date format CCYY-MM-DDTHH:MM:SS.
Attribute	firstDeliveryDateTime	dateTime	0..1	The earliest date at which the supplier can deliver the product to the trading partner.
Attribute	firstShipDateTime	dateTime	0..1	Indicates the earliest date that the trade item can be shipped. This is independent of any specific ship-from location.
Attribute	endAvailabilityDateTime	dateTime	0..1	The date from which the trade item is no longer available from the information provider, including seasonal or temporary trade item and services.
Attribute	endDateTimeOfExclusivity	dateTime	0..1	The date and time at which a product is no longer exclusive to that trading partner.
Attribute	endMaximumBuyingQuantityDateTime	dateTime	0..1	The end date for when the maximum buying quantity is no longer available to the trading partner.
Attribute	endMinimumBuyingQuantityDateTime	dateTime	0..1	The end date for when the minimum buying quantity is no longer available to the trading partner.
Attribute	firstOrderDateTime	dateTime	0..1	Indicates the earliest date that an order can be placed for the trade item.
Attribute	goodsPickupLeadTime	Measurement	0..1	Time (in weeks, days, hours ...) required between order entry and the earliest goods release (use for pick-up, not use for delivery). Remark about ordering lead-time : Geographic distance from manufacturing / distribution point to delivery point impacts this value (relationship dependant data).



content	attribute / role	datatype /secondary class	multiplicity	definition
Attribute	isOneTimeBuy	NonBinaryLogicEnumeration	0..1	An indicator whether or not the item will only be available for order once then discontinued.
Attribute	isProductCustomizable	boolean	0..1	Indicates whether the Items that the Retailer markets are customizable to meet the end consumer's requirements.
Attribute	isTradeItemReorderable	boolean	0..1	This element is an indicator that selected styles or trade items may or may not be re-ordered. It does not imply any information on current availability.
Attribute	isTradeItemShippedInMultipleContainers	boolean	0..1	Indicates that more than one box is to be delivered when the trade item is ordered.
Attribute	isTradeItemSizeBasedPricing	boolean	0..1	This is an indicator that an item may be at a different price point than other similar SKUs (GTIN's price within a Style may differ).
Attribute	lastOrderDateTime	dateTime	0..1	Indicates the latest date that an order can be placed for the trade item.
Attribute	lastShipDateTime	dateTime	0..1	Indicates the latest date that the trade item can be shipped. This is independent of any specific ship-from location.
Attribute	orderingUnitOfMeasure	string	0..1	The alternate Unit of Measure of how Trade Items are ordered by the Retailer under one Unit of Measure, but sold under another Unit of Measure.
Attribute	orderQuantityMaximum	nonNegativeinteger	0..1	The maximum quantity of the trade item that can be ordered. A number or a count. This value can represent the total number of units ordered over a set period of time with multiple orders.
Attribute	orderQuantityMinimum	nonNegativeinteger	0..1	Represent an agreed to minimum quantity of the trade item that can be ordered. A number or a count. This applies to each individual order. Can be a fixed amount for all customers in a target market.
Attribute	orderQuantityMultiple	nonNegativeinteger	0..1	The order quantity multiples in which the trade item may be ordered. If the Order Quantity Minimum is 100, and the Order Quantity Multiple is 20, then the trade item can only be ordered in quantities which are divisible by the Order Quantity Multiple of 20.
Attribute	orderSizingFactor	Measurement	0..*	A trade item specification other than gross, net weight, or cubic feet for a line trade item or a transaction, used for order sizing and pricing purposes. For example, factors may be used to cube a truck, reflecting different weights, and dimensions of trade item.

content	attribute / role	datatype /secondary class	multiplicity	definition
Attribute	shippingQuantityMinimum	nonNegativeInteger	0..1	The minimum total quantity of this trade item that can be shipped.
Attribute	startAvailabilityDateTime	dateTime	0..1	The date (CCYY-MM-DDTHH:MM:SS) from which the trade item becomes available from the supplier, including seasonal or temporary trade item and services.
Attribute	startDateMaximumBuyingQuantity	dateTime	0..1	The start date for when the maximum buying quantity is available to the trading partner.
Attribute	startDateMinimumBuyingQuantity	dateTime	0..1	The start date for when the minimum buying quantity is available to the trading partner.
Attribute	consumerEndAvailabilityDateTime	dateTime	0..1	The last date/time that the trading partner is allowed to sell the trade item to consumers. Usually related to a specific geography. ISO 8601 date format CCYY-MM-DDTHH:MM:SS.
Attribute	consumerFirstDeliveryDate	dateTime	0..1	The first date/time that the buyer is allowed to deliver or ship the trade item to consumers. Usually related to a specific geography.
Attribute	startDateTimeOfExclusivity	dateTime	0..1	The date and time at which a product starts to be exclusive to a trading partner.
Association	avpList	GS1_AttributeValuePairList	0..1	The transmission of non-standard data done in a simple, flexible, and easy to use method.
DeliveryPurchasingInformationModule				A module containing purchasing and delivery information for a trade item.
Association		DeliveryPurchasingInformation	0..1	Purchasing and delivery information for a trade item.
Association		GS1_AttributeValuePairList	0..1	Attribute value pair information for a trade item.

5.20 Diet Information Module

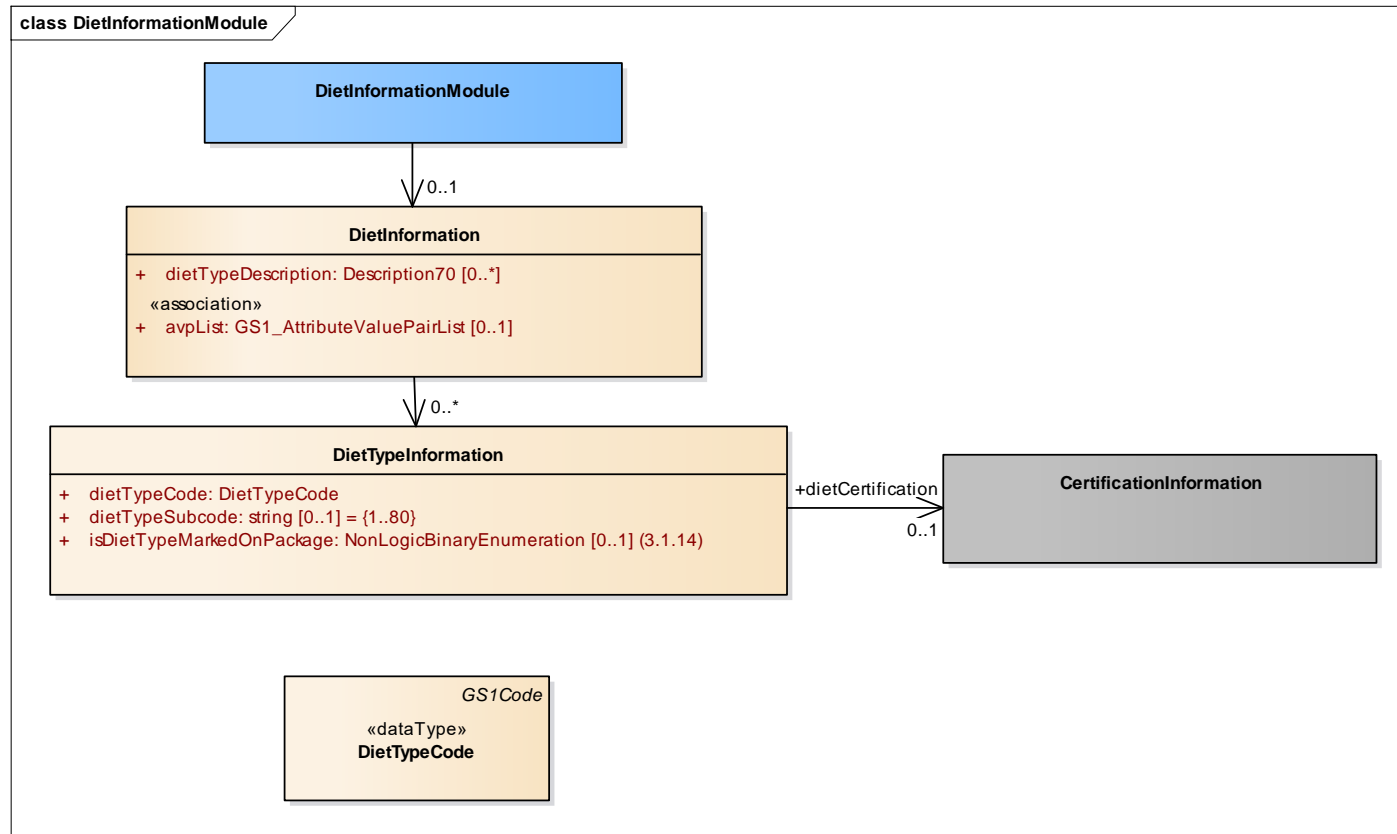

Note: Common class (in grey) is located in the GDSN Common Library.

Content	Attribute / Role	Datatype /Secondary class	Multipli city	Definition
DietInformationModule				Information on whether the product meets the criteria to be classified as suitable for a specific targeted group. Certain groups of consumers are limited in consuming products, depending on the ingredients or preparation style. This can be i.e. due to religious reasons or restriction of diet reasons.
Association		DietInformation	0..1	Information on whether the product meets the criteria to be classified as suitable for a specific targeted group. Certain groups of consumers are limited in consuming products, depending on the ingredients or preparation style. This can be i.e. due to religious reasons or restriction of diet reasons.
DietInformation				Information on whether the product meets the criteria to be classified as suitable for a specific targeted group. Certain groups of consumers are limited in consuming products, depending on the ingredients or preparation style. This can be i.e. due to religious reasons or restriction of diet reasons.
Attribute	dietTypeDescription	Description70	0..*	Free text for indication of diet not stated in the list of diets.
Association		DietTypeInfo	0..*	Information on the type of diet.
Association	avpList	GS1_AttributeValuePairList	0..1	The transmission of non-standard data done in a simple, flexible, and easy to use method.
DietTypeInfo				Information on the type of diet.
Attribute	dietTypeCode	DietTypeCode	1..1	Code indicating the diet the product is suitable for.
Attribute	dietTypeSubcode	string	0..1	Indicates a set of agreements or a certificate name that guarantees the product is permitted in a particular diet.
Attribute	isDietTypeMarkedOnPackage	NonLogicBinaryEnumeration	0..1	Is the diet type specified by dietTypeCode (and sometimes dietTypeSubcode) labelled on the product package?
Association	dietCertification	CertificationInformation	0..1	A certification associated with a specific diet.

5.21 Durable Goods Characteristics Module

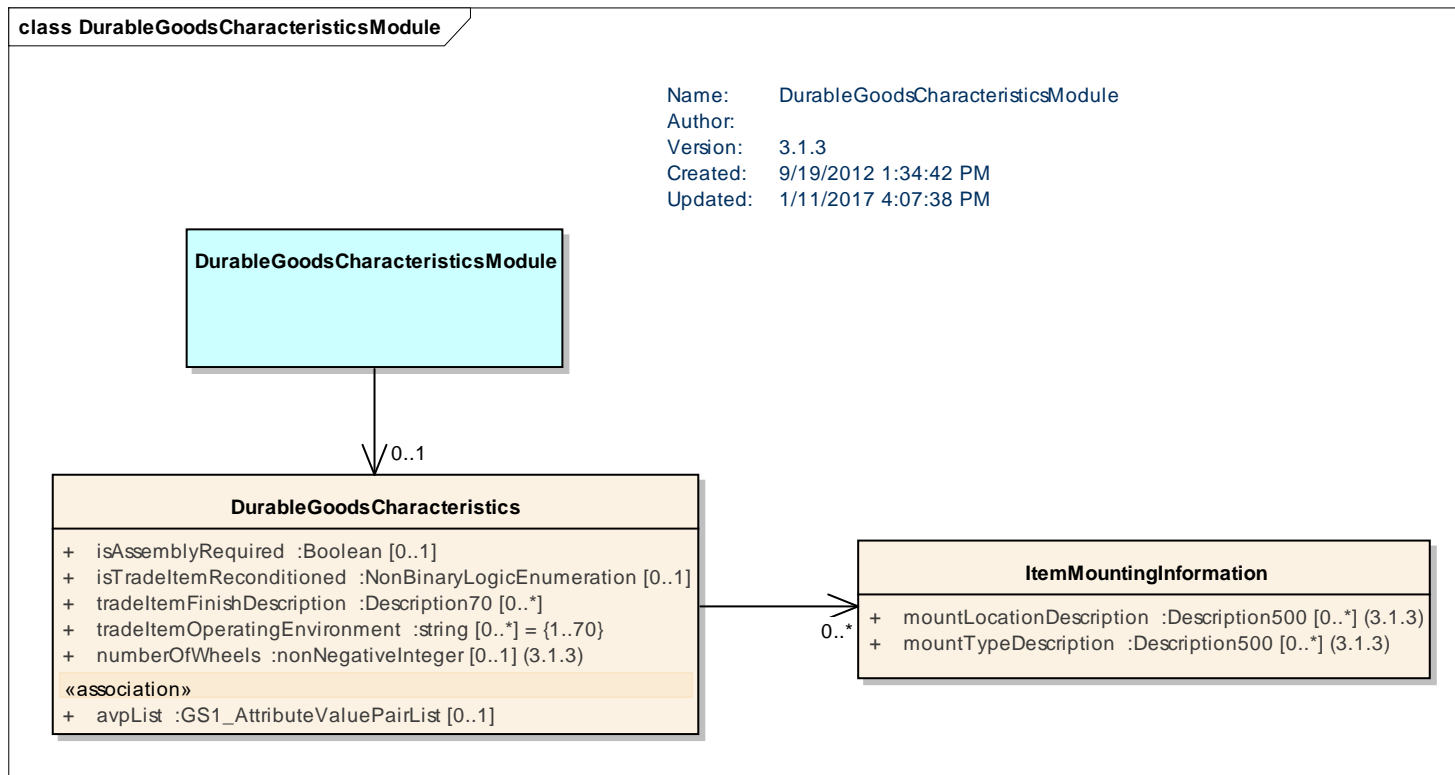

Content	Attribute / Role	Datatype / Secondary class	Multiplicity	Definition
DurableGoodsCharacteristicsModule		DurableGoodsCharacteristics		A module containing attributes applicable to a broad range of durable goods.

Content	Attribute / Role	Datatype /Secondary class	Multipli city	Definition
Association		DurableGoodsCharac teristics	0..1	Attributes applicable to a broad range of durable goods.
DurableGoodsChara cteristics				Attributes applicable to a broad range of durable goods.
Association	avpList	GS1_AttributeValueP airList	0..1	The transmission of non-standard data done in a simple, flexible, and easy to use method.
Attribute	isAssembyRequired	Boolean	0..1	Indicates that the Items in the package need to be assembled for use.
Attribute	isTradeItemReconditi oned	NonBinaryLogicEnu meration	0..1	An indicator whether or not this item is a remanufactured (or rebuilt) or reconditioned part.
Attribute	tradeItemFinishDescr iption	Description	0..*	An attribute which defines the outer surface/appearance of the product.
Attribute	tradeItemOperatingE nvironment	String	0..*	The physical area(s) in which the manufacturer has designed the unit to be operated or installed for example underground, underwater, inside, outside etc.
Attribute	numberOfWheels	nonNegativeInteger	0..1	The number of wheels that the trade item has.
Association		ItemMountingInfor mation	0..*	Details on how an item can be mounted for example to a wall or a surface.
ItemMountingInfor mation				Details on how an item can be mounted for example to a wall or a surface.
Attribute	mountLocationDescr iption	Description500	0..*	A description of how the item is mounted for use especially with shelves for example on the wall, ceiling or floor.
Attribute	mountTypeDescriptio n	Description500	0..*	Describes the type of mount for the light bulb for example swivel, bracket, tilt, articulating.

5.22 Duty Fee Tax Information Module

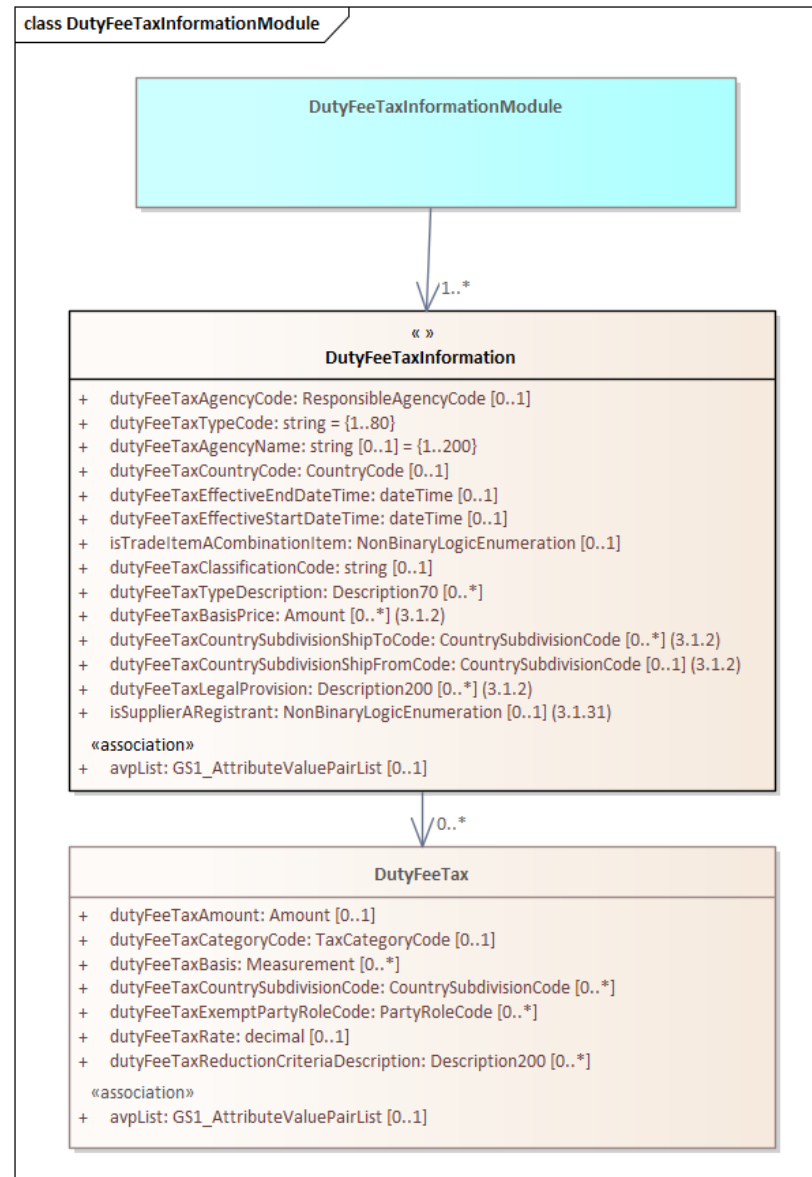

content	Attribute / role	datatype /secondary class	multiplicity	definition
DutyFeeTax				Details on a duty, fee or tax which may be applicable to a trade item including applicability, rate and amount.
Attribute	dutyFeeTaxAmount	Amount	0..1	The current tax or duty or fee amount applicable to the trade item.
Attribute	dutyFeeTaxCategoryCode	TaxCategoryCode	0..1	Depicts the applicability of the tax rate or amount for a trade item, for example, zero low or exempt.
Attribute	dutyFeeTaxBasis	Measurement	0..*	This is defined as a taxation basis for a corresponding levying type and class, for example, for a steel tax on an item with a screw cap weighing "3" grams the tax basis would be 3 grams.
Attribute	dutyFeeTaxCountrySubdivisionCode	CountrySubdivisionCode	0..*	The political subdivision (e.g. province or state) where a specific tax or tax rate\value are applicable.
Attribute	dutyFeeTaxExemptPartyRoleCode	PartyRoleCode	0..*	The party role (e.g. Consumer) that is exempt from a specific tax duty or fee.
Attribute	dutyFeeTaxRate	decimal	0..1	The current tax or duty rate percentage applicable to the trade item.
Attribute	dutyFeeTaxReductionCriteriaDescription	Description200	0..*	The conditions under which a supplier is entitled to a particular tax reduction.
Association	avpList	GS1_AttributeValuePairList	0..1	The transmission of non-standard data done in a simple, flexible, and easy to use method.
DutyFeeTaxInformation				A duty, fee or tax which may be applicable to a trade item.
Association		DutyFeeTax	0..*	Contains information on the applicability and or rate\value for a specific duty fee or tax.
Attribute	dutyFeeTaxAgencyCode	ResponsibleAgencyCode	0..1	Identifies the agency responsible for the tax code list
Attribute	dutyFeeTaxTypeCode	string	1..1	Identification of the type of duty or tax or fee applicable to the trade item. This will vary by target market.
Attribute	dutyFeeTaxAgencyName	string	0..1	The name of an agency responsible for the collection of this duty
Attribute	dutyFeeTaxBasisPrice	Amount	0..*	The price that is determined a trade item should be set to by legal means within a market. This price is the basis to which the tax is set to. Some trade item prices are dictated by law in some markets.

content	Attribute / role	datatype /secondary class	multiplicity	definition
Attribute	dutyFeeTaxCountryCode	CountryCode	0..1	The country that a duty, fee or tax may be applicable to for a trade item.
attribute	dutyFeeTaxCountrySubdivisionShipFromCode	CountrySubdivisionCode	0..1	The country subdivision the item is being shipped from in which the tax basis is made.
attribute	dutyFeeTaxCountrySubdivisionShipToCode	CountrySubdivisionCode	0..*	The Country subdivision the item is being shipped to in which the tax basis is made.
Attribute	dutyFeeTaxClassificationCode	string	0..1	A code specifying the broad category of duty, fee or tax, for example, energy, waste, environment.
Attribute	dutyFeeTaxEffectiveEndDateTime	dateTime	0..1	The effective date on which the tax, fee or duty must end being collected.
Attribute	dutyFeeTaxEffectiveStartDateTime	dateTime	0..1	The effective date on which the tax, fee or duty must start being collected.
attribute	dutyFeeTaxLegalProvision	Description200	0..*	The associated legal tax law that the tax information is based on. An example in Brazil: Inciso I, Art. 34, Anexo II, RICMS-SP.
Attribute	dutyFeeTaxTypeDescription	Description70	0..*	A description of tax type, for example, "Taxes sur les supports audio".
Attribute	isTradeItemACombinationItem	NonBinaryLogicEnumeration	0..1	An indicator whether a product assigned with one GTIN contains components which could have different tax rates, for example, chocolate eggs with toys would be chocolate 7% and toy 19%.
Attribute	isSupplierARegistrant	NonBinaryLogicEnumeration	0..1	The indicator that specifies whether the supplier is registered with the tax collecting organisation.
Association	avpList	GS1_AttributeValuePairList	0..1	The transmission of non-standard data done in a simple, flexible, and easy to use method.
DutyFeeTaxInformationModule				A module containing information on a duty, fee or tax which may be applicable to a trade item.
Association		DutyFeeTaxInformation	1..*	A duty, fee or tax which may be applicable to a trade item.



5.23 Electronic Device Characteristics Information Module

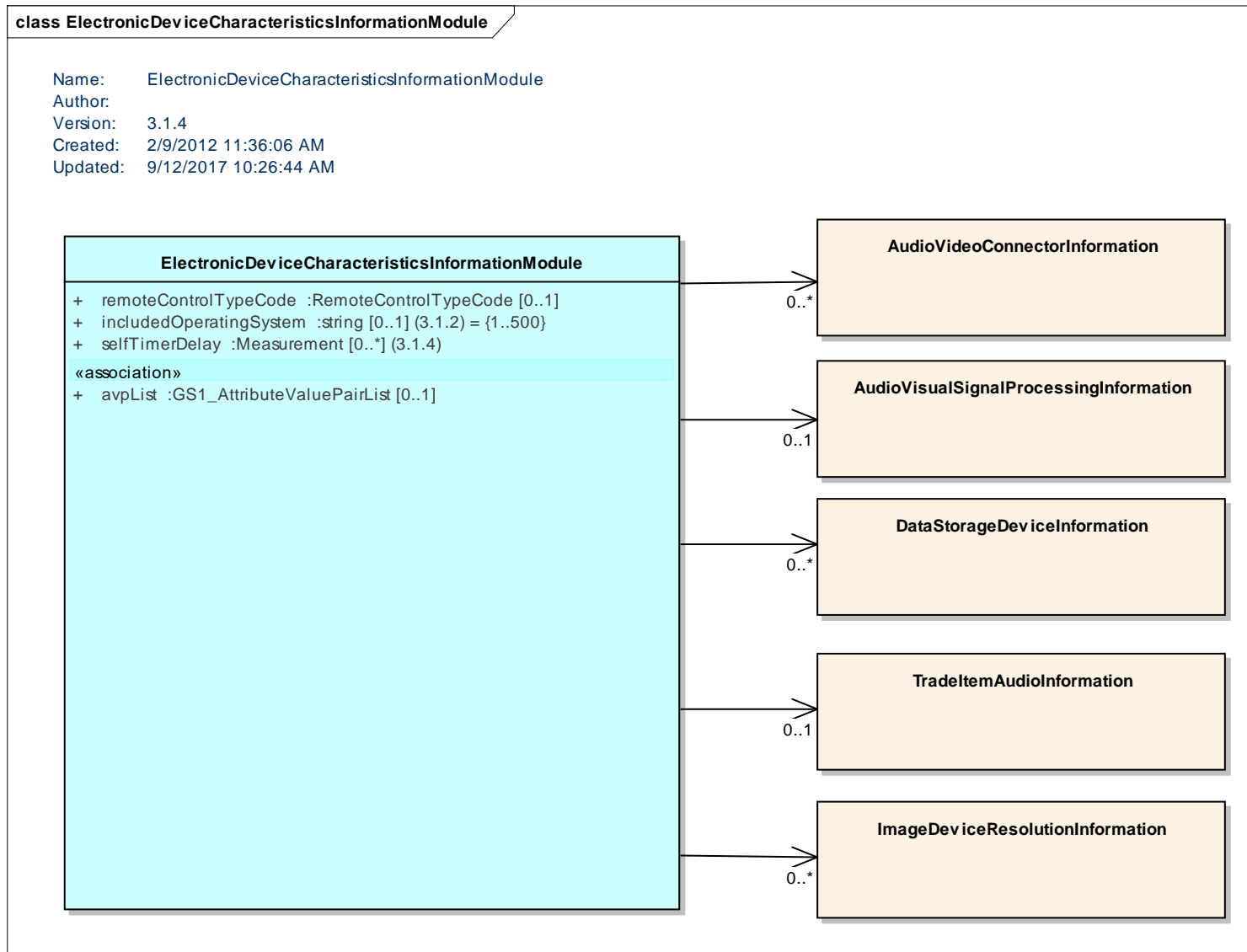

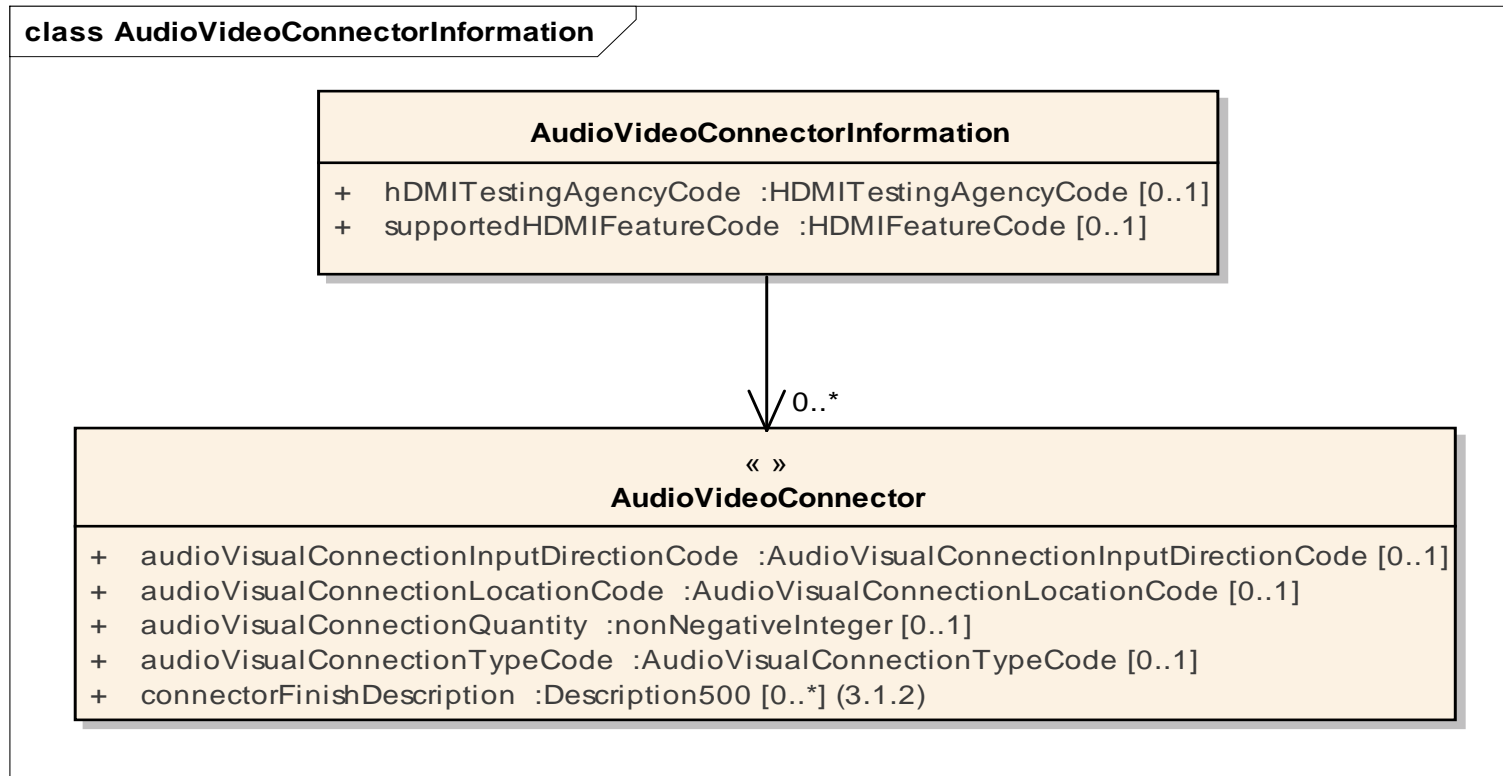

class AudioVisualSignalProcessingInformation**AudioVisualSignalProcessingInformation**

- + availableChannelStationQuantity :nonNegativeInteger [0..1]
- + electronicProgrammingGuideDaysAvailable :nonNegativeInteger [0..1]
- + signalProcessingTypeCode :SignalProcessingTypeCode [0..1]
- + tunerTypeCode :TunerTypeCode [0..*]

class DataStorageDeviceInformation**DataStorageDeviceInformation**

- + externalMemoryTypeCode :ExternalMemoryTypeCode [0..*]
- + internalMemoryTypeCode :InternalMemoryTypeCode [0..1]
- + maximumAvailableStorageCapacity :Measurement [0..*] (3.1.3)

class ImageDeviceResolutionInformation**ImageDeviceResolutionInformation**

- + maximumResolution :Measurement [0..*] (3.1.2)
- + resolutionTypeCode :ResolutionTypeCode [0..1] (3.1.2)

class TradeItemAudioInformation**TradeItemAudioInformation**

- + detachableSpeakerTypeCode :DetachableSpeakerTypeCode [0..1]
- + fixedSpeakerLocationCode :FixedSpeakerLocationCode [0..1]
- + surroundSoundDigitalDecoderTypeCode :SurroundSoundDigitalDecoderTypeCode [0..*]
- + totalAudioPowerOutput :Measurement [0..*]
- + microphoneTypeCode :MicrophoneTypeCode [0..1] (3.1.2)
- + equalizerControlFeatures :Description500 [0..*] (3.1.4)

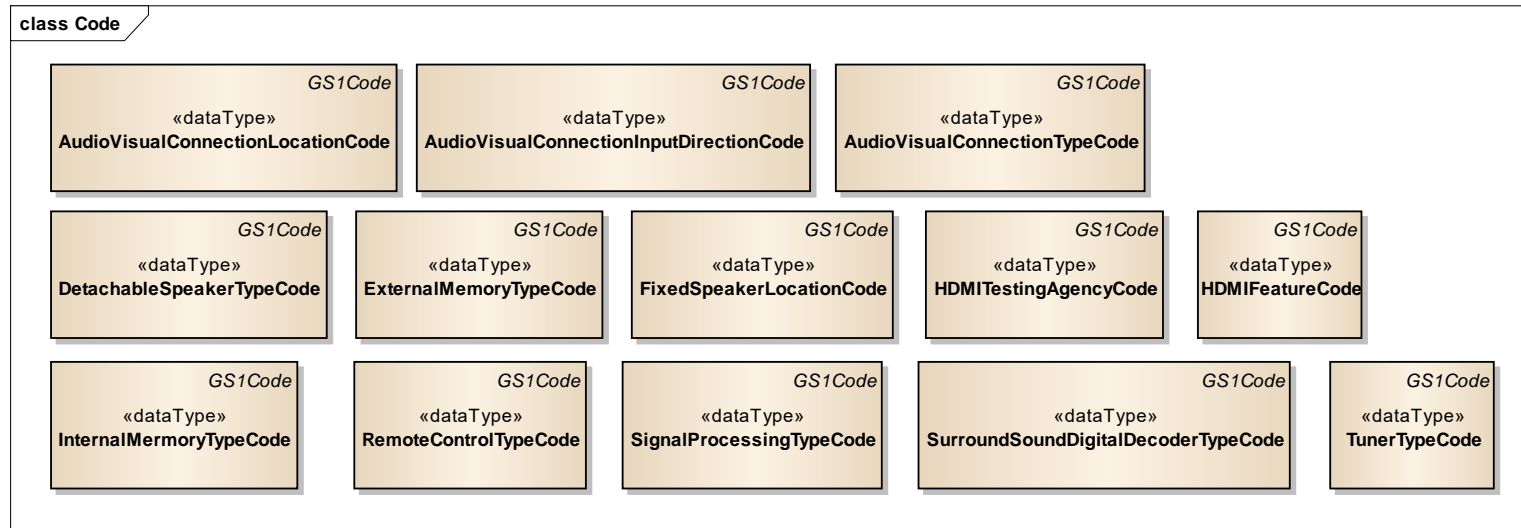

Content	Attribute / Role	Datatype /Secondary class	Multi plici ty	Definition
AudioVideoConnectorInfor mation				Audio Video Connector information for a trade item.
Association		AudioVideoConnector	0..*	Audio Video Connector information for a trade item.
Attribute	hDMITestingAgencyCo de	HDMITestingAgencyCode	0..1	The testing agency that has certified all of the product’s HDMI inputs or outputs as a code. HDMI/ HDCP interoperability is tested either by SimplayHD or another Authorized Testing Centre with the 1.2a specification. The High-Definition multimedia Interface (HDMI) is a compact audio/video connector interface for transmitting uncompressed digital streams. High-bandwidth Digital Content Protection (HDCP) is a form of digital copy protection.

Content	Attribute / Role	Datatype /Secondary class	Multi plicity	Definition
Attribute	supportedHDMIFeatureCode	HDMIFeatureCode	0..1	The type of features that are supported by the High-Definition multimedia Interface. The High-Definition Multimedia Interface (HDMI) is a compact audio/video connector interface for transmitting uncompressed digital streams.
AudioVideoConnector				Audio Video Connector information for a trade item.
Attribute	audioVisualConnectionInputDirectionCode	AudioVisualConnectionInputDirectionCode	0..1	The directions of connections (input, output) that are available expressed as a code value.
Attribute	audioVisualConnectionLocationCode	AudioVisualConnectionLocationCode	0..1	The location on the unit of any audio visual connector for example top.
Attribute	audioVisualConnectionQuantity	nonNegativeInteger	0..1	The number of audio visual connections available on the unit expressed as a code.
Attribute	audioVisualConnectionTypeCode	AudioVisualConnectionTypeCode	0..1	The types of Standard or Basic Connection Types that are available expressed as a code.
Attribute	connectorFinishDescription	Description500	0..*	The plating used on the electrical mating surfaces of connectors.
AudioVisualSignalProcessingInformation				Information on signal processing for a trade item. Signal processing is the ability to perform useful operations on signals.
Attribute	availableChannelStationQuantity	nonNegativeInteger	0..1	The number of channels available on the unit expressed as an integer.
Attribute	electronicProgrammingGuideDaysAvailable	nonNegativeInteger	0..1	The number of days available in an electronic programming guide expressed as an integer. The electronic programming guide feature is the capability for the users to interact with an intelligent guide.
Attribute	signalProcessingTypeCode	SignalProcessingTypeCode	0..1	The type of processing capability of the television to receive and process enhanced signal types expressed as a code for example Analogue.
Attribute	tunerTypeCode	TunerTypeCode	0..*	A tuner type is the technology used for the built-in receiver expressed as a code for example HD (high definition). A tuner receives broadcasts and converts them into signals.

Content	Attribute / Role	Datatype /Secondary class	Multi plicity	Definition
DataStorageDeviceInformation				Information on included data storage devices associated with the trade item.
Attribute	externalMemoryTypeCode	ExternalMemoryTypeCode	0..*	The components, devices, and recording media that retain digital data that is external to the device expressed as a code.
Attribute	internalMemoryTypeCode	InternalMemoryTypeCode	0..1	The components, devices, and recording media that retain digital data that is internal to the device expressed as a code.
Attribute	maximumAvailableStorageCapacity	Measurement	0..*	The maximum data storage capacity available within the trade item for electronic file storage hardware.
ElectronicDeviceCharacteristicsInformationModule				A module containing technical and other product characteristics for electronic items.
Association		AudioVisualSignalProcessingInformation	0..1	Signal processing information for a trade item.
Association		TradeItemAudioInformation	0..1	Information on audio functionality of a Trade Item.
Association		DataStorageDeviceInformation	0..*	Information on included data storage devices associated with the trade item.
Association		AudioVideoConnectorInformation	0..*	Audio Video Connector Information for a trade item.
Association		ImageDeviceResolutionInformation	0..*	Details on the resolution for an image device such as a camera.
Association	avpList	GS1_AttributeValuePairList	0..1	The transmission of non-standard data done in a simple, flexible, and easy to use method.
Attribute	includedOperatingSystem	String	0..1	The operating system loaded on the trade item, device or upon which the software is designed to operate.
Attribute	remoteControlTypeCode	RemoteControlTypeCode	0..1	The type of remote control functionality available with a unit expressed as a code.
Attribute	selfTimerDelay	Measurement	0..*	The amount of time the timer on a camera runs before the mechanism triggers the action. Example 2 seconds, 10 seconds, custom.

Content	Attribute / Role	Datatype /Secondary class	Multi plicity	Definition
ImageDeviceResolutionInformation				Details on the resolution for an image device such as a camera.
attribute	maximumResolution	Measurement	0..*	The maximum resolution of the image device, measured in dots/pixels per some measure.
attribute	resolutionTypeCode	ResolutionTypeCode	0..1	The qualifier describing the resolution of the device expressed as a code for example IMAGE.
TradeItemAudioInformation				Information on audio functionality of a Trade Item.
Attribute	detachableSpeakerTypeCode	DetachableSpeakerTypeCode	0..1	The type of detachable speakers available on the unit for example wireless.
Attribute	equalizerControlFeatures	Description500	0..*	A description of the types of equalizer on an audio musical unit that are available. An equalizer allows the sound in specified frequency bands to be amplified or reduced, in order to adjust the quality and character of the sound. Examples: Bass; Mid; Treble; Parametric.
Attribute	fixedSpeakerLocationCode	FixedSpeakerLocationCode	0..1	The location of speakers that cannot be detached available on the unit.
Attribute	microphoneTypeCode	microphoneTypeCode	0..1	The type of microphone the trade item contains expressed as a code for example WIRELESS.
Attribute	surroundSoundDigitalDecoderTypeCode	SurroundSoundDigitalDecoderTypeCode	0..*	The type of feature capable of decoding and playback of particular sound systems expressed as a code for example DTS HD.
Attribute	totalAudioPowerOutput	Measurement	0..*	The total audio power output of the product expressed in Watts.

5.24 Farming And Processing Information Module

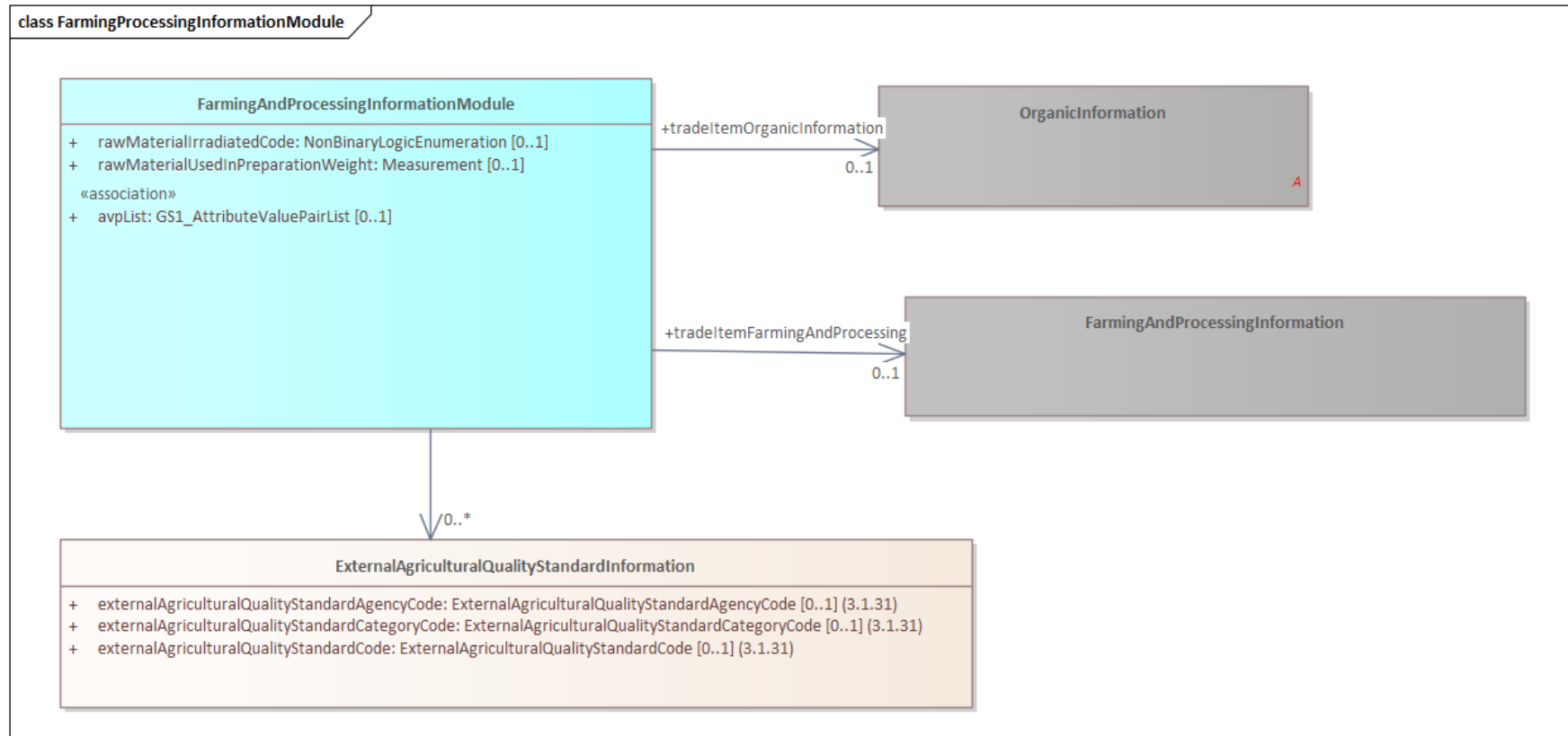

Note: Common class (in grey) is located in the GDSN Common Library.

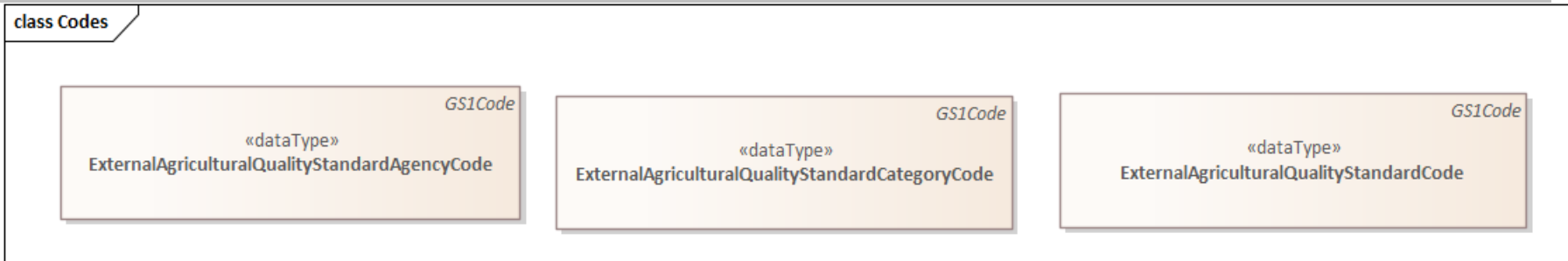

content	attribute / role	datatype /secondary class	multiplcity	definition
FarmingAndProcessingInformationModule				Information on any farming or processing performed on and agricultural trade item.
Association	tradeItemOrganicInformation	OrganicInformation	0..1	Details on the trade item regarding the extent of organic production.
Association	tradeItemFarmingAndProcessing	FarmingAndProcessingInformation	0..1	Information on farming and processing for a trade item.
Association	avpList	GS1_AttributeValuePairList	0..1	Attribute value pair information.
Attribute	rawMaterialIrradiatedCode	NonBinaryLogicEnumeration	0..1	Indicates if radiation has been applied to a trade item's raw material.
Attribute	rawMaterialUsedInPreparationWeight	Measurement	0..1	The weight of the raw materials (meat) used to produce the finished food product. The weight of the raw materials (for example fat) can differ from the weight of the ingredient in the finished product. In some countries there are legal stipulations that the weight of the raw material used must be indicated if a product is produced using more than 100% of the finished product.
ExternalAgriculturalQualityStandardInformation				The set of information that provides an external standard of agricultural products.
Attribute	externalAgriculturalQualityStandardAgencyCode	ExternalAgriculturalQualityStandardAgencyCode	0..1	The code indicating the external agency that is responsible for the agricultural standard.



content	attribute / role	datatype /secondary class	multipl city	definition
Attribute	externalAgriculturalQ ualityStandardCatego ryCode	ExternalAgricultura IQualityStandardCa tegorCode	0..1	The code indicating the external category that describes the type of information pertaining to the agricultural code.
Attribute	ExternalAgriculturalQ ualityStandardCode	ExternalAgricultura IQualityStandardCo de	0..1	The code indicating the information related to the category for the external agricultural standard.

5.25 Food And Beverage Ingredient Module

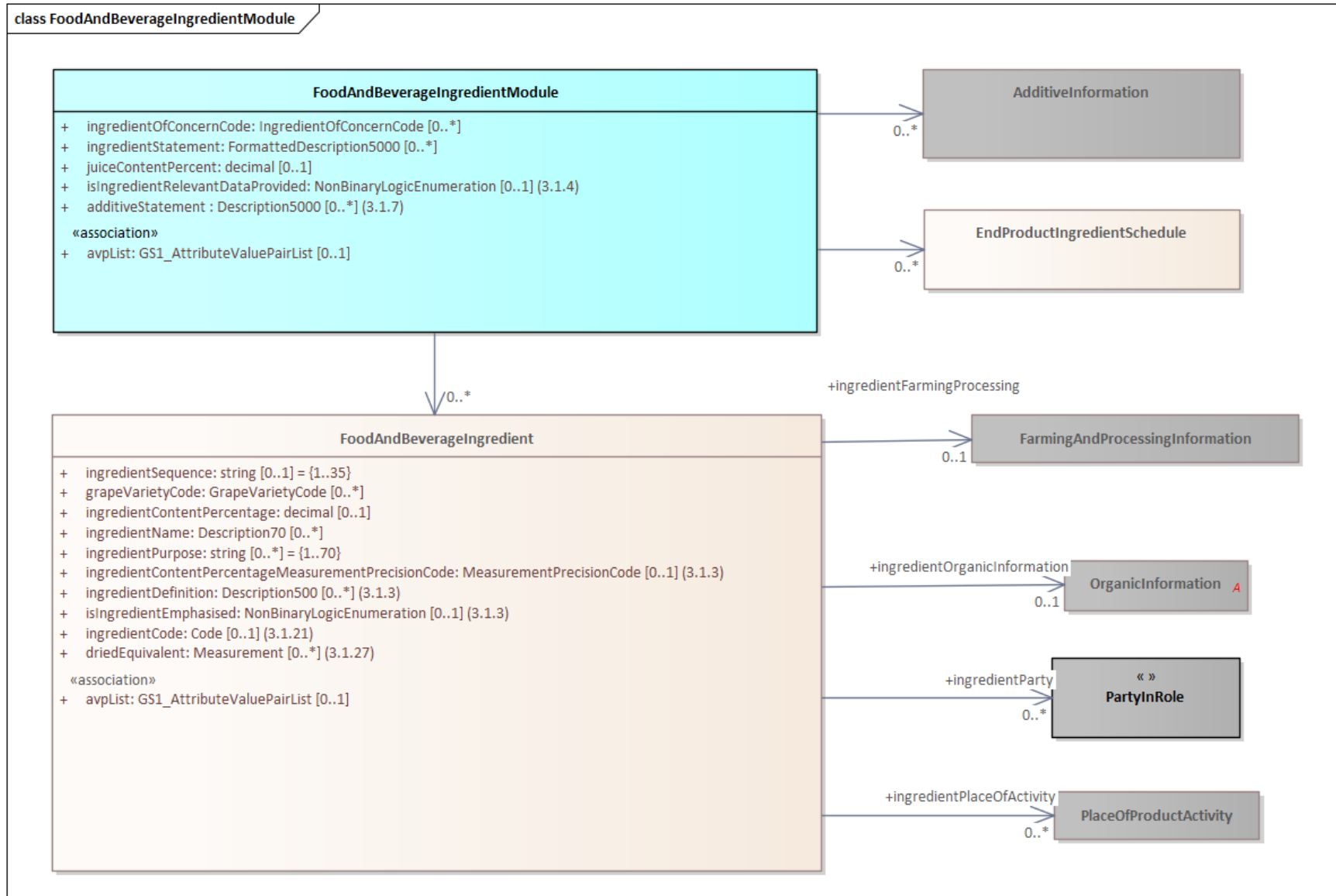

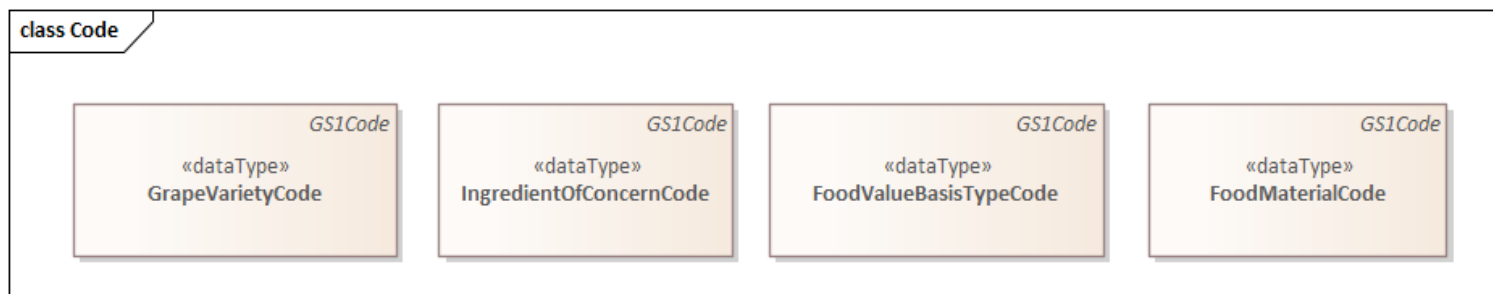
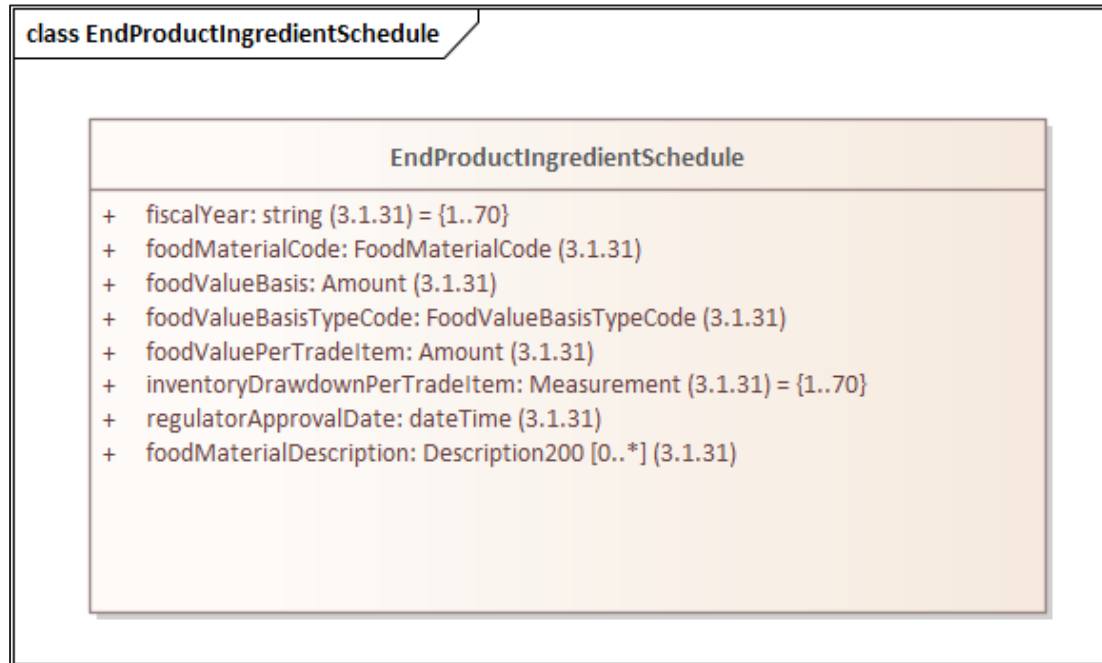

Content	Attribute / Role	Datatype / Secondary class	Multiplcity	Definition
FoodAndBeverageIngredient				Information on the constituent ingredient make up of the product split out per ingredient.
Association	ingredientParty	PartyInRole	0..*	Party and party role information that relates to an ingredient to describe growers, breeders, etc.
Association	ingredientFarmingAndProcessing	FarmingAndProcessing	0..1	Details on any methods and techniques used to grow or produce the ingredient.
Association	ingredientOrganicInformation	OrganicInformation	0..1	Information on the organic nature of an ingredient.
Association	ingredientPlaceOfActivity	PlaceOfProductActivity	0..*	Information on the activity (e.g. bottling) taken place for an ingredient as well as the associated geographic area.
Association	avpList	GS1_AttributeValuePairList	0..1	Attribute value pair information.
Attribute	ingredientSequence	string	0..1	Incremental value (01, 02, 03...) indicating the ingredient order by content percentage of the product. (major ingredient = 01, second ingredient =01.01) etc.
Attribute	grapeVarietyCode	GrapeVarietyCode	0..*	The vine variety used for the production of this wine for example Merlot expressed as a code.
Attribute	ingredientContentPercentage	decimal	0..1	Indication of the percentage of the ingredient contained in the product.
Attribute	ingredientName	Description70	0..*	Text field indicating one ingredient or ingredient group (according to regulations of the target market). Ingredients include any additives (colourings, preservatives, e-numbers, etc) that are encompassed.
Attribute	ingredientPurpose	string	0..*	A description of the primary purpose that an ingredient serves for example a colouring in the case of annatto in a cheese rind.
Attribute	ingredientContentPercentageMeasurementPrecisionCode	MeasurementPrecisionCode	0..1	The measurement precision qualifying the ingredient content percentage for example LESS_THAN.

Content	Attribute / Role	Datatype /Secondary class	Multiplcity	Definition
Attribute	ingredientDefinition	Description500	0..*	Plain language definitions of ingredients which are consumer friendly.
Attribute	isIngredientEmphasised	NonBinaryLogicEnumeration	0..1	Denotes that the ingredient should have its text emphasised.
Attribute	ingredientCode	Code	0..1	The code indicating an ingredient (according to regulations of the target market). Select values from the GS1 code list IngredientCode_GDSN, which is based on an extract of the Codex Alimentarius international food standard developed jointly by the Food and Agriculture Organization (FAO) of the United Nations and World Health Organization (WHO).
Attribute	driedEquivalent	Measurement	0..*	The equivalent quantity amount of dried ingredient to an ingredient found in the product. The determination of this is made by the supplier and is subject to target market regulations or trade organization guidelines.
FoodAndBeverageIngredientInformationModule				Information on the constituent ingredient make up of the product.
Association		FoodAndBeverageIngredient	0..*	Ingredient details for a food and beverage item.
Association		AdditiveInformation	0..*	Information on presence or absence of additives or genetic modifications contained in the trade item.
Association	avpList	GS1_AttributeValuePairList	0..1	Attribute value pair information.
Attribute	additiveStatement	Description5000	0..*	Statement on presence or absence of additives or genetic modification contained in the trade item for example "Contains no preservatives, no artificial colours or flavours and no artificial flavours".
Attribute	isIngredientRelevantDataProvided	NonBinaryLogicEnumeration	0..1	A flag indicating that all of the relevant or required ingredient information has been provided.
Attribute	ingredientOfConcernCode	IngredientOfConcernCode	0..*	Indicates a claim to an ingredient, considered to be a concern for regulatory or other reasons, and which is "contained" within the trade item but may not need to specify the amount whether approximate or an accurate measurement be given.
Attribute	ingredientStatement	FormattedDescription5000	0..*	Information on the constituent ingredient make-up of the product specified as one string.
Attribute	juiceContentPercent	decimal	0..1	The fruit juice content of the trade item expressed as a percentage.

Content	Attribute / Role	Datatype /Secondary class	Multipli city	Definition
EndProductIngredientSchedule				Information on the regulated ingredients used by schools or other institutional meal programs.
Attribute	fiscalYear	String	1..1	Fiscal year is the 12-month period during which the information is applicable, relative to the end product ingredient being used in the final product. This should be tied to the applicable regulatory fiscal year for the school or other institutional meal program.
Attribute	foodMaterialCode	FoodMaterialCode	1..1	A code the regulator has assigned to an end product ingredient being used in the final product.
Attribute	foodMaterialDescription	Description200	0..*	Descriptive terms assigned by the regulator for the end product ingredient being used in the final product.
Attribute	inventoryDrawdownPerTradeItem	Measurement	1..1	Measurement of the amount of the end product ingredient being used in the final product.
Attribute	foodValueBasis	Amount	1..1	Monetary value per unit (specified by the Food Value Basis Type Code) for the end product ingredient being used in the final product.
Attribute	foodValueBasisTypeCode	FoodValueBasisTypeCode	1..1	The code that indicates the basis for the monetary unit value (specified by the Food Value Basis) of the end product ingredient being used in the final product.
Attribute	foodValuePerTradeItem	Amount	1..1	Total monetary value of the end product ingredient being used in the final product. This is calculated by multiplying the Food Value Basis by the Inventory Drawdown Per Trade Item, where the UoM and the Food Value Basis Type Code align.
Attribute	regulatorApprovalDate	dateTime	1..1	Date on which the regulator approved use of the specified ingredient.

5.26 Food and Beverage Preparation Serving Module

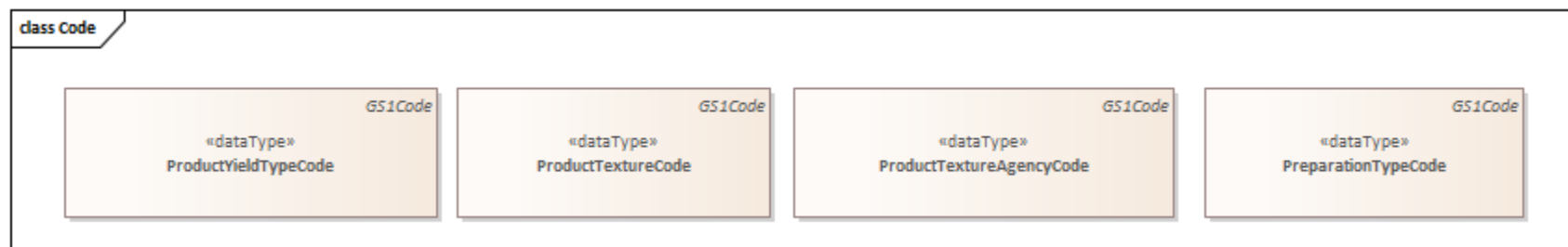
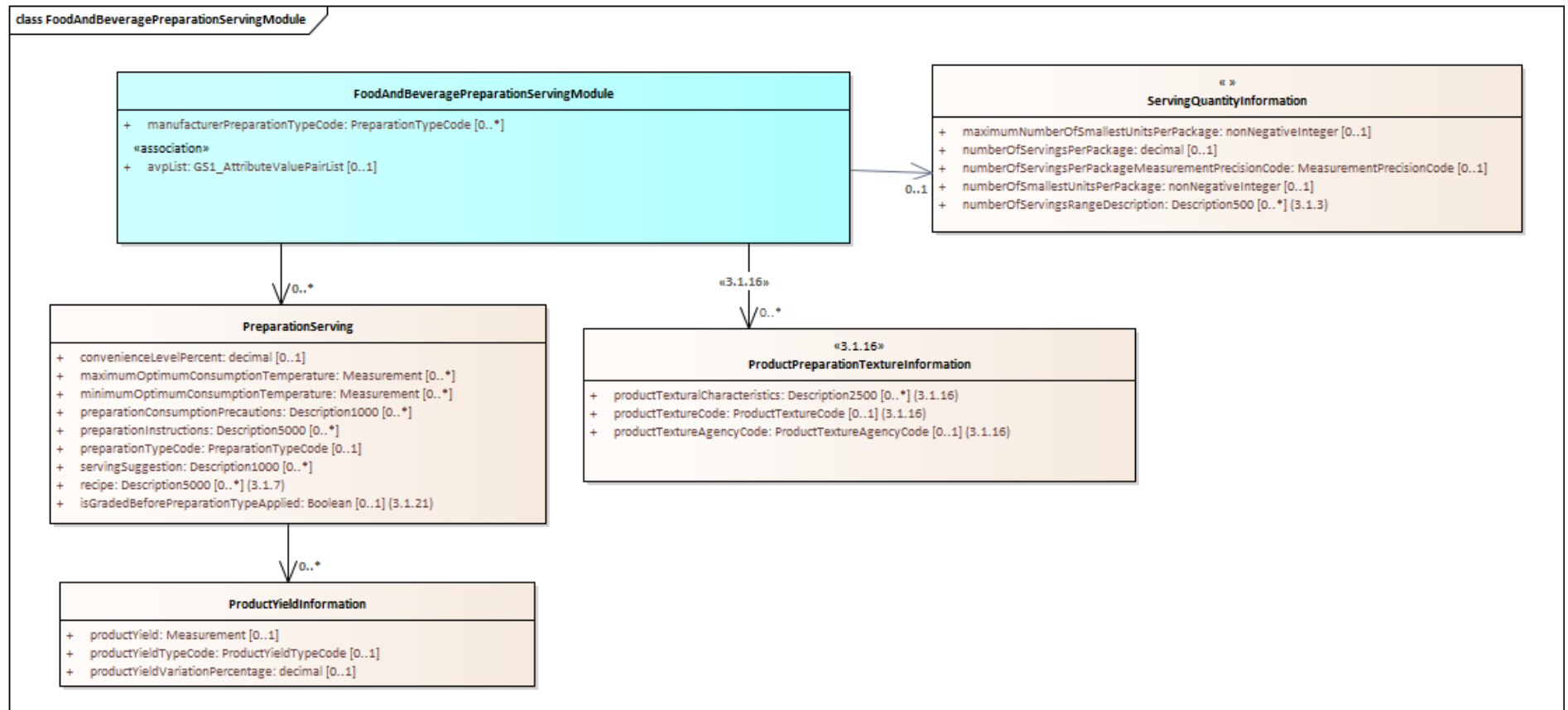

content	attribute / role	datatype /secondary class	multiplcity	definition
FoodAndBeveragePreparationServingModule				Information on way the product can be prepared or served.
Attribute	manufacturerPreparationTypeCode	PreparationTypeCode	0..*	The code specifying the preparation methods the manufacturer has used on the product during the manufacturing process.
Association		PreparationServing	0..*	Preparation and serving information for a food and beverage item.
Association		ServingQuantityInformation	0..1	Information on the number of servings and units contained in the package.
Association	avpList	GS1_AttributeValuePairList	0..1	The transmission of non-standard data done in a simple, flexible, and easy to use method.
PreparationServing				Information on way the product can be prepared or served.
Association		ProductYieldInformation	0..*	Information on the yield of a product.
Attribute	convenienceLevelPercent	decimal	0..1	An indication of the ease of preparation for semi-prepared products. The convenience level indicates the level of preparation in percentage required to prepare and helps the consumer to assess how long it will take to prepare the meal.
Attribute	maximumOptimumConsumptionTemperature	Measurement	0..*	The upper limit drinking temperature of the optimum range of the drinking temperature. The optimum range of the drinking temperature is a recommendation and is based on the experience of the individual producer.
Attribute	minimumOptimumConsumptionTemperature	Measurement	0..*	The lower limit drinking temperature of the optimum range of the drinking temperature. The optimum range of the drinking temperature is a recommendation and is based on the experience of the individual producer.
Attribute	preparationConsumptionPrecautions	Description1000	0..*	Specifies additional precautions to be taken before preparation or consumption of the product.
Attribute	preparationInstructions	Description5000	0..*	Textual instruction on how to prepare the product before serving.

content	attribute / role	datatype /secondary class	multipl city	definition
Attribute	preparationTypeCode	PreparationTypeCode	0..1	A code specifying the technique used to make the product ready for consumption. For example: baking, boiling.
Attribute	recipe	Description5000	0..*	A description of how the product is used with other ingredients to yield a new result different than the trade item.
Attribute	servingSuggestion	Description1000	0..*	Free text field for serving suggestion.
Attribute	isGradedBeforePreparationTypeApplied	Boolean	0..1	An indicator specifying that a product is graded prior to a manufacturer applying a preparation method.
ProductPreparation TextureInformation				A group of attributes that explain a product's texture during and/or after preparation.
Attribute	productTextureAgencyCode	ProductTextureAgencyCode	0..1	The code for the agency which maintains the food and drinks texture or thickness code list. For example, International Dysphagia Diet Standardisation Initiative (IDSSI)
Attribute	productTextureCode	ProductTextureCode	0..1	Specify the texture or thickness of the contained product as a code.
Attribute	productTexturalCharacteristics	Description2500	0..*	Statement by the brand owner as noted on the product packaging to describe and confirm the flow or textural characteristics of a particular product at the time of testing.
ProductYieldInformation				Information on the yield of a product.
Attribute	productYield	Measurement	0..1	Product quantity after preparation.
Attribute	productYieldTypeCode	ProductYieldTypeCode	0..1	Code indicating the type of yield measurement. Examples: After dilution, Drained weight, After cooking, etc.
Attribute	productYieldVariationPercentage	decimal	0..1	Indication of range in percent of the given cooking / roasting loss. Percentage that the actual weight of the trade item differs upward or downward from the average or estimated product yield.
ServingQuantityInformation				Information on the number of servings and units contained in the package.

content	attribute / role	datatype /secondary class	multiplcity	definition
Attribute	maximumNumberOfSmallestUnitsPerPackage	nonNegativeInteger	0..1	The maximum number of the smallest units contained in the package. This attribute is to be used in conjunction with numberOfSmallestUnitsPerPackage in order to enter a minimum and maximum value. For example for a package of meatballs where the smallest units per package could be from 56-60, the maximumNumberOfSmallestUnitsPerPackage would be 60.
Attribute	numberOfServingsPerPackage	decimal	0..1	The total number of servings contained in the package.
Attribute	numberOfServingsPerPackageMeasurementPrecisionCode	MeasurementPrecisionCode	0..1	Code indicating whether the number of servings per package is exact or approximate. One should follow local regulatory guidelines when selecting a precision.
Attribute	numberOfSmallestUnitsPerPackage	nonNegativeInteger	0..1	The total number of smallest units contained in the product. The smallest unit cannot be further divided without breaking or slicing the product. The smallest units may be uniform or may include a variety of items.
Attribute	numberOfServingsRangeDescription	Description500	0..*	A text description describing the range of servings/portions contained within a trade item. Some items may contain a variance in the number of units or a range, therefore the servings could also vary for the trade item. This attribute should only be used when there is a range of servings. If servings is an exact amount, this should not be used. An example of its use would be a bag of meatballs may contain 18-20 meatballs. If the serving size is 2 meatballs then the numberOfServingsRange would be 9-10 servings or portions.

5.27 Food and Beverage Properties Information Module

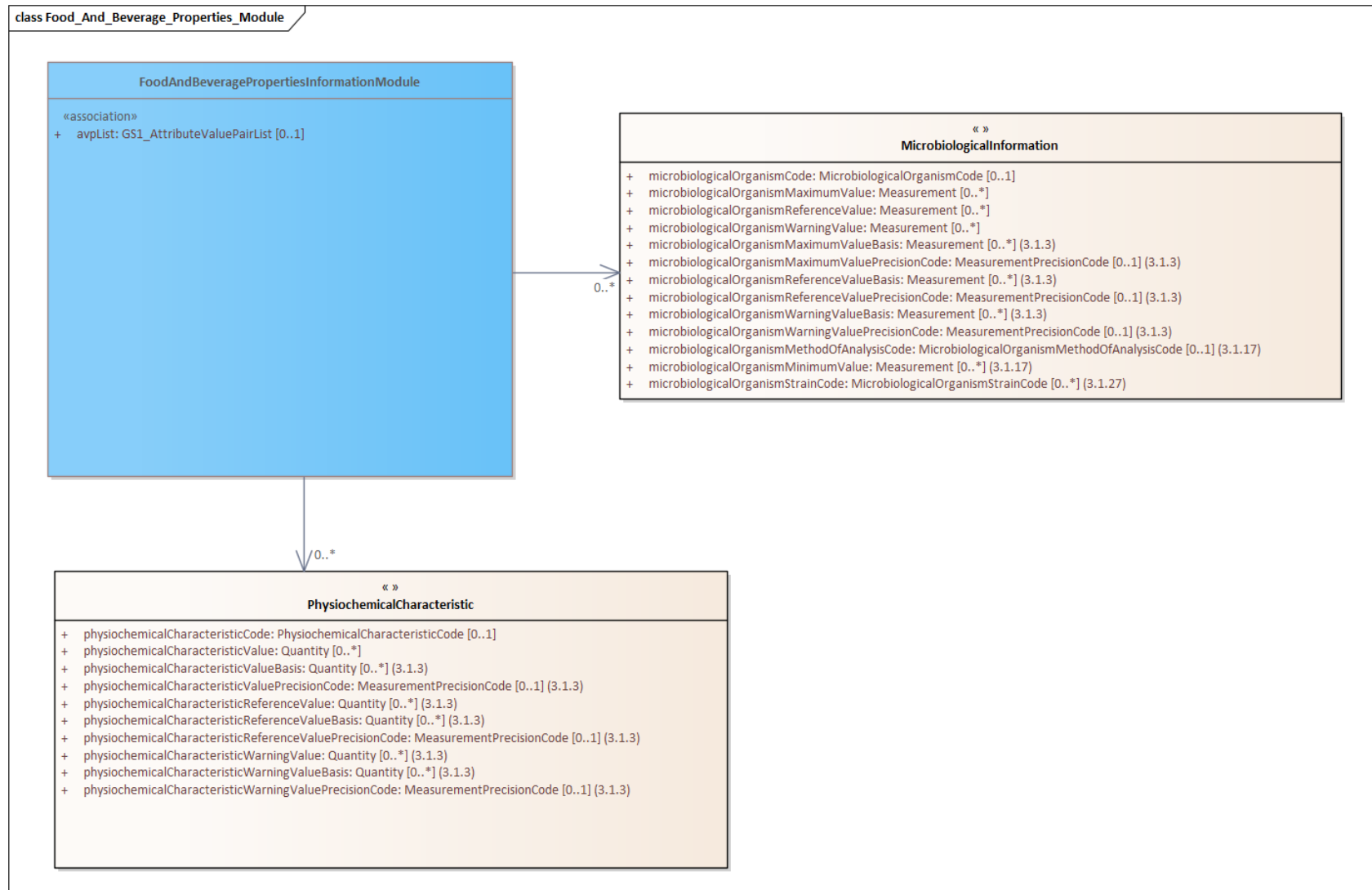

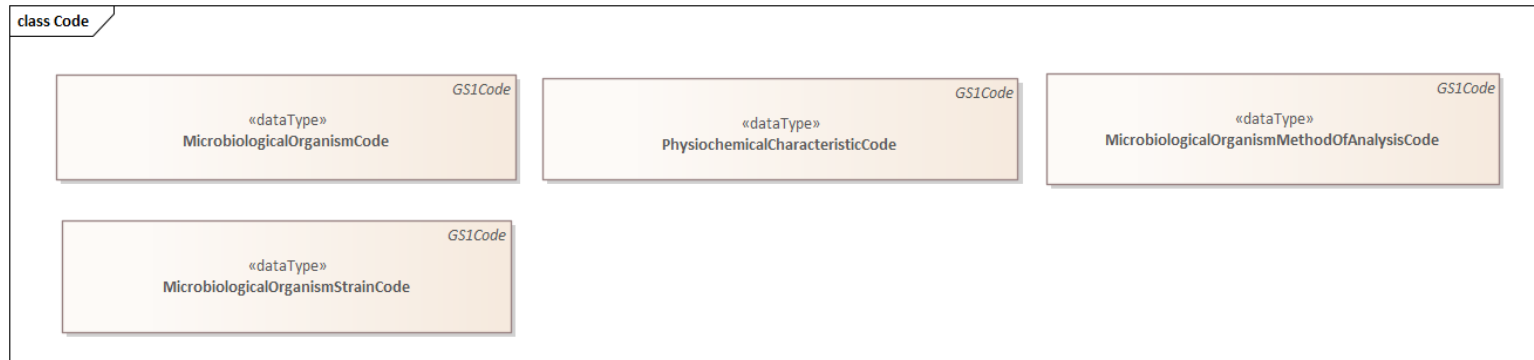

content	attribute / role	datatype /secondary class	multiplcity	definition
FoodAndBeverage PropertiesInformationModule				Information on physiochemical or other properties of food and beverage products.
Association	avpList	GS1_AttributeValuePairList	0..1	The transmission of non-standard data done in a simple, flexible, and easy to use method.
Association		MicrobiologicalInformation	0..*	Information on the maximum allowable presence of certain micro-organisms as guaranteed by the manufactures upon receipt of the goods.
Association		PhysiochemicalCharacteristic	0..*	Information on the product's physicochemical characteristics.
MicrobiologicalInformation				Information on the maximum allowable presence of certain micro-organisms as guaranteed by the manufactures upon receipt of the goods.
Attribute	microbiologicalOrganismCode	MicrobiologicalOrganismCode	0..1	Code indicating the type of microbiological organism.
Attribute	microbiologicalOrganismMaximumValue	Measurement	0..*	The maximum allowable value of the microbiological organism per weight or volume in a specific environment.

content	attribute / role	datatype /secondary class	multiplcity	definition
Attribute	microbiologicalOrganismMethodOfAnalysisCode	MicrobiologicalOrganismMethodOfAnalysisCode	0..1	Method of analysis used to determine quantity of the specified microbiological organism (E.g. probiotic live microbe) in the product. Example: Aerobic plate count, Flow cytometry.
Attribute	microbiologicalOrganismMinimumValue	Measurement	0..*	The minimum allowable value of the microbiological organism per weight or volume in a specific environment.
Attribute	microbiologicalOrganismReferenceValue	Measurement	0..*	Reference values give an indication of which product specific ranges of micro organisms are to be expected and which micro organism contents in the appropriate food products are acceptable due to hygiene rules. Per definition this value reflects a microbiological limit which in a 2-class plan, separates good quality from defective quality or in a 3-class plan, separates good quality from marginally acceptable quality. With regard to the audit of the production processes exceeding the microbiological reference limit means, it indicates there are leak points in the production process and the hygienic situation needs to be increased.
Attribute	microbiologicalOrganismWarningValue	Measurement	0..*	A microbiological limit which, in a 3-class plan, separates marginally acceptable quality from defective quality. Exceeding the limits of the allowed content of micro-organisms defined as warning values indicating there is a poor quality of the hygiene standard in the food production. This would probably lead to health hazards.
Attribute	microbiologicalOrganismMaximumValueBasis	Measurement	0..*	Used to express the analytical circumstances in which the maximum value was measured (e.g. in 10 g or 200 mg/kg).
Attribute	microbiologicalOrganismMaximumValuePrecisionCode	MeasurementPrecisionCode	0..1	The measurement precision used for the measurement of the organism maximum value for example UNDETECTABLE.
Attribute	microbiologicalOrganismReferenceValueBasis	Measurement	0..*	Used to express the analytical circumstances in which the reference value was measured (e.g. in 10 g or 200 mg/kg).
Attribute	microbiologicalOrganismReferenceValuePrecisionCode	MeasurementPrecisionCode	0..1	A code specifying the precision of the measurement of the organism reference value for example EXACT.
Attribute	microbiologicalOrganismWarningValueBasis	Measurement	0..*	Used to express the analytical circumstances in which the warning value was measured (e.g. in 10 g or 200 mg/kg).
Attribute	microbiologicalOrganismWarningValuePrecisionCode	MeasurementPrecisionCode	0..1	A code specifying the precision of the measurement of the organism warning value for example EXACT.

content	attribute / role	datatype /secondary class	multipl city	definition
Attribute	microbiologicalOrganis mStrainCode	MicrobiologicalOrg anismStrainCode	0..*	The code indicating the strain of microbiological organism found in the product.
PhysiochemicalCh aracteristic				Information on the product's physicochemical characteristics.
Attribute	physiochemicalCharact eristicCode	PhysiochemicalCha racteristicCode	0..1	Code indicating the type of physiochemical characteristic.
Attribute	physiochemicalCharact eristicValue	Quantity	0..*	Measurement value of the physicochemical characteristic.
Attribute	physiochemicalCharact eristicValueBasis	Quantity	0..*	Used to express the analytical circumstances in which the value was measured (e.g. in 10 g or 200 mg/kg). This is to specify the circumstance of the metric a foundation of the measure values has to be.
Attribute	physiochemicalCharact eristicValuePrecisionCo de	MeasurementPrci sionCode	0..1	A code specifying the precision of the measurement of the physiochemical characteristic for example EXACT.
Attribute	physiochemicalCharact eristicReferenceValue	Quantity	0..*	The measured value of the physiochemical characteristic or a value which results of several tests during the production process.
Attribute	physiochemicalCharact eristicReferenceValueB asis	Quantity	0..*	Used to express the analytical circumstances in which the reference value was measured (e.g. in 10 g or 200 mg/kg). This is to specify the circumstance of the metric a foundation of the measure values has to be.
Attribute	physiochemicalCharact eristicReferenceValueP recisionCode	MeasurementPrci sionCode	0..1	A code specifying the precision of the reference value of the physiochemical characteristic for example EXACT.
Attribute	physiochemicalCharact eristicWarningValue	Quantity	0..*	A warning limit according to a regulation (e.g. regulation EG 2073/2005). This value can differ from the value and the characteristic reference value.
Attribute	physiochemicalCharact eristicWarningValueBa sis	Quantity	0..*	Used to express the analytical circumstances in which the warning value was measured (e.g. in 10 g or 200 mg/kg). This is to specify the circumstance of the metric a foundation of the measure values has to be.
Attribute	physiochemicalCharact eristicWarningValuePrc sionCode	MeasurementPrci sionCode	0..1	A code specifying the precision of the warning value of the physiochemical characteristic for example EXACT.

5.28 Health Related Information Module

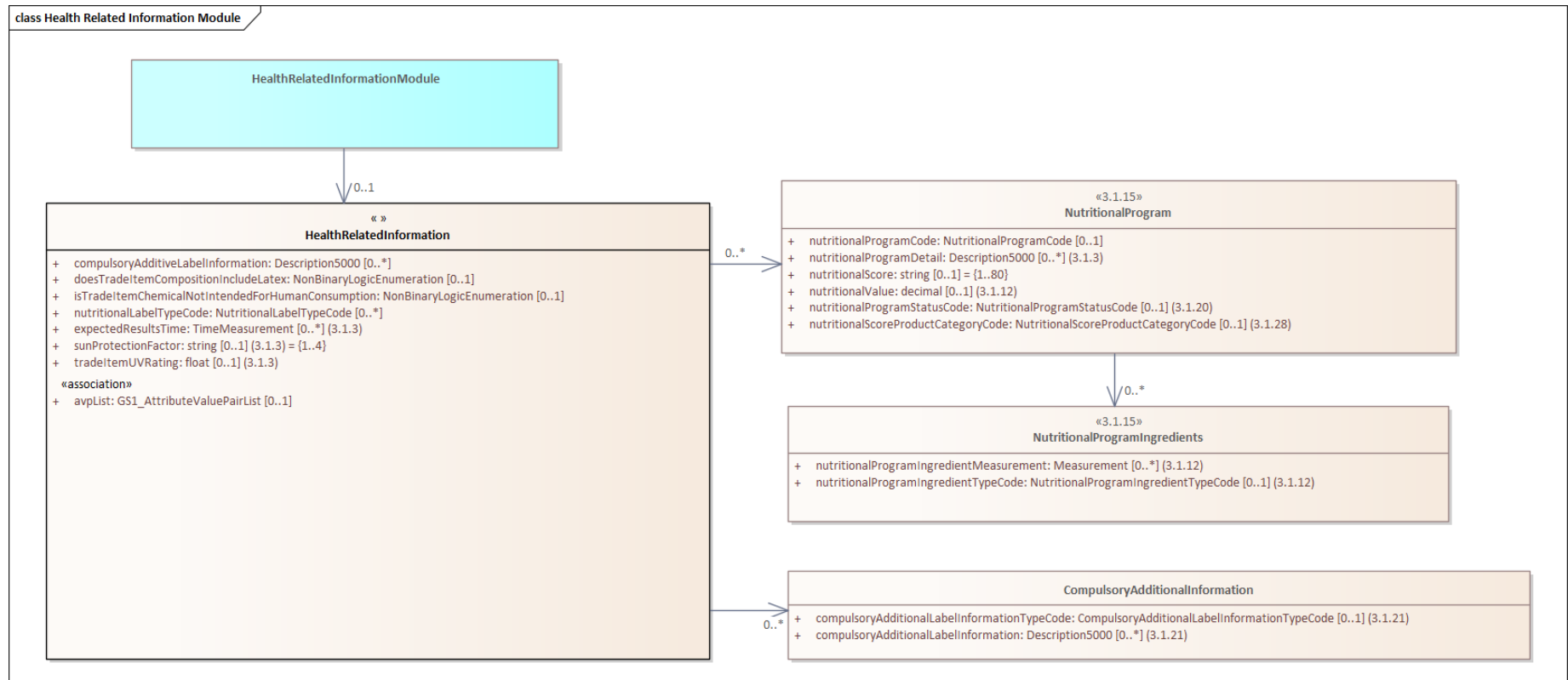



Content	Attribute / Role	Datatype /Secondary class	Multipli city	Definition
HealthRelatedInfor mationModule				A module containing marketing or regulatory information specific to health or safety.
Association		HealthRelatedInfor mation	0..1	A module containing marketing or regulatory information specific to health or safety.
HealthRelatedInfor mation				Marketing or regulatory information specific to health or safety.
Association	avpList	GS1_AttributeValu ePairList	0..1	The transmission of non-standard data done in a simple, flexible, and easy to use method.
Attribute	compulsoryAdditiveLab elInformation	Description5000	0..*	A description of any compulsory label information on the product. For example, the German additives regulation (ZzulV), for products such as meats and sausages, meat products, bread and bread products is needed for the serving counter.
Attribute	doesTradeItemComposi tionIncludeLatex	NonBinaryLogicEnu meration	0..1	Identifies if any of the trade item’s components or pieces contain latex.

Content	Attribute / Role	Datatype /Secondary class	Multiplcity	Definition
Attribute	isTradeItemChemicalNotIntendedForHumanConsumption	NonBinaryLogicEnumeration	0..1	Indicates that the trade item is or contains a Liquid, Gel, Paste, Powder, or Flammable solid not intended for human consumption (ingested).
Attribute	nutritionalLabelTypeCode	NutritionalLabelTypeCode	0..*	Code indicating that the trade item is eligible for certain nutritional labelling programs according to a specific regulation
Attribute	expectedResultsTime	TimeMeasurement	0..*	The amount of time the consumer can expect to see the results as described on the product for example 10 days.
Attribute	sunProtectionFactor	string	0..1	It is a measure of Ultra Violet B (UVB) radiation protection and ranges from 1 to 90.
Attribute	tradeItemUVRating	float	0..1	The ultra violet rays protection rating of the product for example 400 or 300. Usually used for eyewear.
CompulsoryAdditionalInformation				The group of compulsory information about a product.
Attribute	compulsoryAdditionalLabelInformation	Description5000	0..*	The legally required/compulsory additional label information as stated on the product packaging or label.
Attribute	compulsoryAdditionalLabelInformationTypeCode	CompulsoryAdditionalLabelInformationTypeCode	0..1	The code indicating the type of the legally required/compulsory additional information that is stated on the product packaging or label.
NutritionalProgram				Information on Nutritional Programs
Attribute	nutritionalProgramCode	NutritionalProgramCode	0..1	Programs designed to encourage people to eat a certain way
Attribute	nutritionalScoreProductCategoryCode	NutritionalScoreProductCategoryCode	0..1	The code indicating the product category of the trade item that is used to calculate the nutritional score.
Attribute	nutritionalProgramDetail	Description5000	0..*	Information providing more detail as to the level or value relevant for the nutritionalProgramCode. For example, 5 points as applicable to the Weight Watchers program. This value should be expressed as text and be as is presented on the item or its packaging.
Attribute	nutritionalProgramStatusCode	NutritionalProgramStatusCode	0..1	A code specifying the status of the brand or product with the nutritional program. Example: REGISTERED - the brand of a product is registered for Nutri-Score at the French Health Ministry.
Attribute	nutritionalScore	string	0..1	A score points or ratings, associated with a nutritional program e.g. A - E for Nutri-Score.
Attribute	nutritionalValue	decimal	0..1	Indicates the exact value of the score points or ratings, associated with a nutritional program e.g. "-1" or "13" for Nutri-Score.



Content	Attribute / Role	Datatype /Secondary class	Multipli city	Definition
NutritionalProgramI nredients				Information on nutritional Program Ingredients
Attribute	nutritionalProgramIngr edientMeasurement	Measurement	0..*	Value and unit of measure associated to the attribute nutritionalProgramIngredientTypeCode
Attribute	nutritionalProgramIngr edientTypeCode	NutritionalProgram IngredientTypeCod e	0..1	Allows to identify the groups of main ingredients contained in the product to better highlight them for the consumer.

5.29 Health Wellness Packaging Marking Module

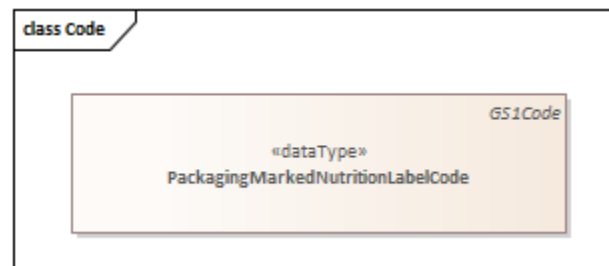
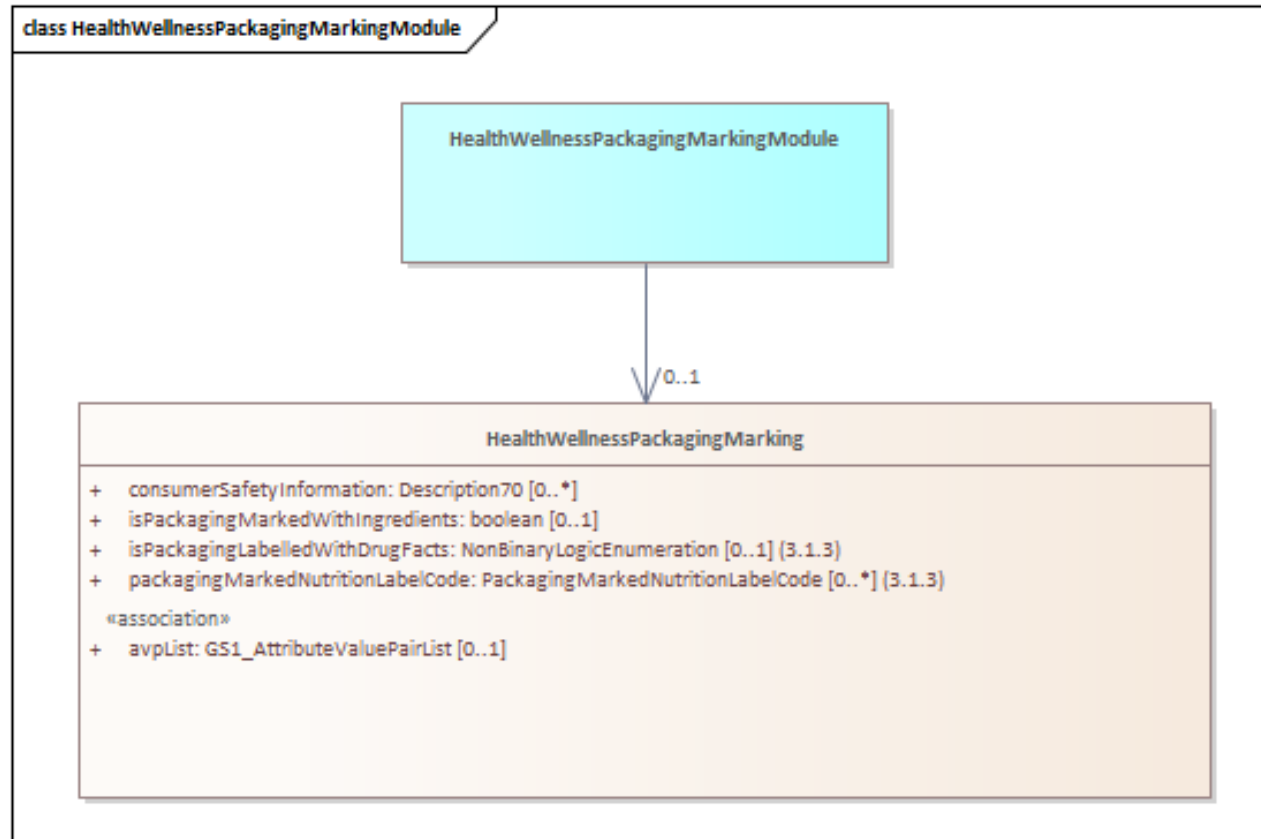

content	Attribute / Role	Datatype /Secondary class	Multipli city	Definition
HealthWellnessPack agingMarkingModule				Indicates any marking on the packaging of a trade item, including labelling of information related to allergens, suitable diet, safety and ingredients.
Association		HealthWellnessPacka gingMarking	0..1	Indicates any marking on the packaging of a trade item, including labelling of information related to allergens, suitable diet, safety and ingredients.
HealthWellnessPack agingMarking				Indicates any marking on the packaging of a trade item, including labelling of information related to allergens, suitable diet, safety and ingredients.
Association	avpList	GS1_AttributeValueP airList	0..1	The transmission of non-standard data done in a simple, flexible, and easy to use method.
Attribute	consumerSafetyInfor mation	Description70	0..*	Information on consumer safety regarding the trade item.
Attribute	isPackagingMarkedWi thIngredients	Boolean	0..1	Trade item packaging contains information pertaining to its ingredients. trade item ingredients are required to be shown on the trade item (normally at base trade item level). This is a yes/no (Boolean) where yes equals marked with ingredients.
Attribute	isPackagingLabelledW ithDrugFacts	NonBinaryLogicEnum eration	0..1	Indicates if the item has drug facts labelling. A drug fact panel of the trade item is a label usually contains such items as active ingredients, uses, warnings, purpose, directions, etc.
Attribute	packagingMarkedNutr itionLabelCode	PackagingMarkedNutr itionLabelCode	0..*	Indication of which nutrition call outs or highlights are on the package. A nutrition call out is a graphic which highlights some elements from the nutrition panel for the consumer to have a quick view for example, Front of Package information.

5.30 Healthcare Item Information Module

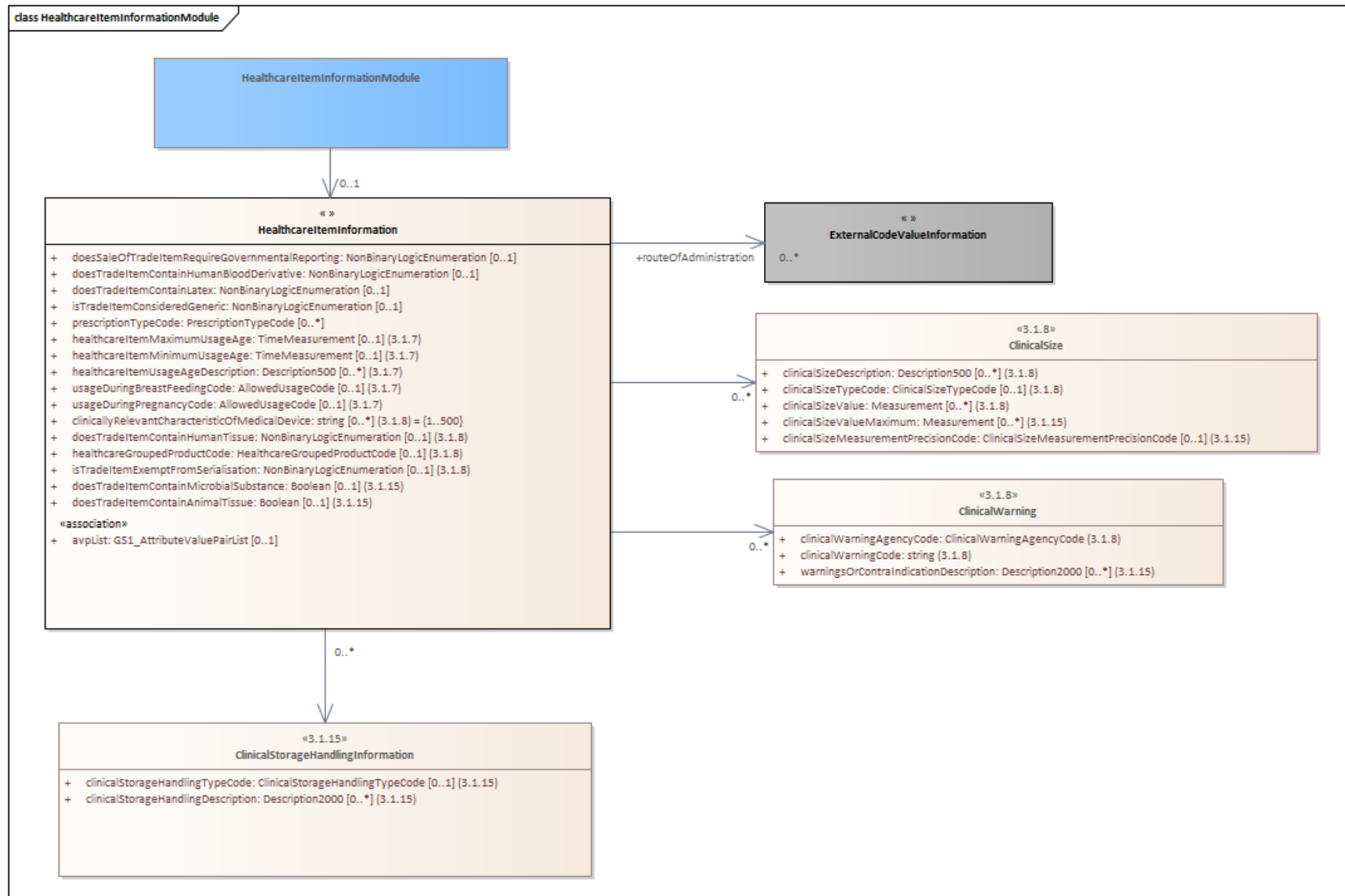

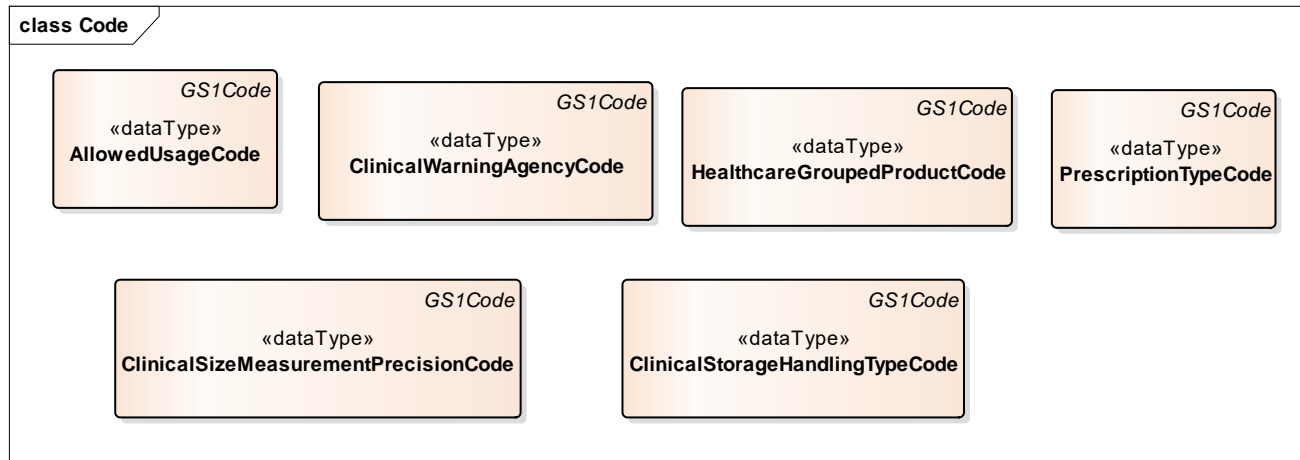

Note: Common class (in grey) is located in the GDSN Common Library.

Content	Attribute / Role	Datatype /Secondary class	Multiplicity	Definition
HealthcareItemInformationModule				Information relevant to all classifications of healthcare items.
Association		HealthcareItemInformation	0..1	Information relevant to all classifications of healthcare items.
ClinicalSize				The dimensional size which is clinically relevant for the use of the trade item by the clinical user.
Attribute	clinicalSizeDescription	Description500	0..*	This is the text used to to denote the dimensional size which is clinically relevant for the use of the trade item by the clinical user. Use when the clinicalSizeType is coded as "DEVICE_SIZE_TEXT_SPECIFY".

Content	Attribute / Role	Datatype /Secondary class	Multi plicity	Definition
Attribute	clinicalSizeTypeCode	ClinicalSizeTypeCode	0..1	The qualifier to denote the dimensional size which is clinically relevant for the use of the trade item by the clinical user. For example "NEEDLE_GAUGE" for a 16 gauge needle, or "VOLUME" for a 200 cc syringe.
Attribute	clinicalSizeValue	Measurement	0..*	The value to denote the dimensional size which is clinically relevant for the use of the trade item by the clinical user. For example 16 gauge for a needle, or 200 cc for a syringe.
Attribute	clinicalSizeMeasurementPrecisionCode	ClinicalSizeMeasurementPrecisionCode	0..1	The precision of the clinical size measures.
Attribute	clinicalSizeValueMaximum	Measurement	0..*	The maximum dimensional size which is clinically relevant for the use of the trade item by the clinical user. For example 16 gauge for a needle, or 200 cc for a syringe.
ClinicalStorageHandlingInformation				
Attribute	clinicalStorageHandlingDescription	Description2000	0..*	Description of the storage or handling conditions or the Critical warnings as clinically relevant for the product
Attribute	clinicalStorageHandlingTypeCode	ClinicalStorageHandlingTypeCode	0..1	The type of Clinical Storage Handling of the medical device.
ClinicalWarning				Clinical warning information is additional information which outlines special requirements, warning and caution information printed on the package.
Attribute	clinicalWarningAgencyCode	clinicalWarningAgencyCode	1..1	The agency which manages the clinical warning codings for example FDA.
Attribute	clinicalWarningCode	string	1..1	Clinical warning information is additional information which outlines special requirements, warning and caution information printed on the package.
Attribute	warningsOrContraIndicationDescription	Description2000	0..*	Description of warnings or contra-indications applicable to the product
HealthcareItemInformation				Information relevant to all classifications of healthcare items.
Association	avpList	GS1_AttributeValuePairList	0..1	Attribute value pair information.

Content	Attribute / Role	Datatype /Secondary class	Multi plicit y	Definition
Association		ClinicalSize	0..*	The dimensional size which is clinically relevant for the use of the trade item by the clinical user.
Association		ClinicalStorageHandlin gInformation	0..*	Group of attributes to provide Storage and Handling information for use of the item in a Clinical Setting.
Association		ClinicalWarning	0..*	Clinical warning information is additional information which outlines special requirements, warning and caution information printed on the package.
Association	routeOfAdministratio n	ExternalCodeValueInfo rmation	0..*	Route of Administration expresses the method(s) of administering the product. In pharmacology and toxicology, a route of administration is the path by which a drug, fluid, or other substance is brought into contact with the body.
Attribute	clinicallyRelevantChar acteristicOfMedicalDe vice	string	0..*	Terms used to describe the clinical characteristics which are relevant for the trade item. These terms will refer to measurement or size appropriate for the trade item, for example 8F Catheter.
Attribute	doesSaleOfTradeItem RequireGovernmental Reporting	NonBinaryLogicEnumer ation	0..1	Indicates whether the government requires the reporting of sale of the trade item.
Attribute	doesTradeItemContai nAnimalTissue	Boolean	0..1	Indication the product has presence of animal tissues or cells or their derivatives.
Attribute	doesTradeItemContai nHumanBloodDerivati ve	NonBinaryLogicEnumer ation	0..1	The use of this attribute indicates that the trade item is a product that contains blood, blood components or blood products used in the manufacturing.
Attribute	doesTradeItemContai nLatex	NonBinaryLogicEnumer ation	0..1	An indication that the trade item has a positive natural rubber latex reference on the trade item's labelling.
Attribute	doesTradeItemContai nHumanTissue	NonBinaryLogicEnumer ation	0..1	Determines whether the trade item has, as a component or ingredient, human tissue. The amount of tissue is not limited to a certain amount, any amount will cause a flag of TRUE.
Attribute	doesTradeItemContai nMicrobialSubstance	Boolean	0..1	Indication the product contains substances of microbial origin.
Attribute	healthcareGroupedPr oductCode	HealthcareGroupedPro ductCode	0..1	A code representing whether a healthcare item is considered by the manufacturer to be more than a single item or for example: kit or combination for FDA 21CFR 830.

Content	Attribute / Role	Datatype /Secondary class	Multiplicity	Definition
Attribute	healthcareItemMaximumUsageAge	TimeMeasurement	0..1	Note: This attribute is being deprecated in a future release. Use targetConsumerUsageTypeCode with the value AGE and targetConsumerMaximumUsage from TargetConsumerUsage class in MarketingInformationModule. The maximum age to which the healthcare item may be used. For example 6 MON or 18 ANN.
Attribute	healthcareItemMinimumUsageAge	TimeMeasurement	0..1	Note: This attribute is being deprecated in a future release. Use targetConsumerUsageTypeCode with the value AGE and targetConsumerMinimumUsage from TargetConsumerUsage class in MarketingInformationModule. The minimum age to which the healthcare item may be used. For example 6 MON or 18 ANN.
Attribute	healthcareItemUsageAgeDescription	Description500	0..*	Note: This attribute is being deprecated in a future release. Use targetConsumerAge from TargetConsumer class in MarketingInformationModule. Additional information regarding the usage age for a healthcare item for example "This product is not indicated for use in children under 6 years of age unless it is advised by a physician."
Attribute	isTradeItemConsideredGeneric	NonBinaryLogicEnumeration	0..1	An indication that the trade item is being produced by someone other than the Brand Innovator of the product. A value of no indicates that it is not considered a "Generic Substitution" of another product.
Attribute	isTradeItemExemptFromSerialisation	NonBinaryLogicEnumeration	0..1	Indicator that a trade item is exempt from current serialisation requirements, for example US requirements. Serialization and traceability requirements may vary by product and country. In some existing instances, certain products have been granted an exception to these regulatory requirements. This attribute will indicate to supply chain participants (wholesalers and dispensers) clearly if a product is expected to be in compliance with serialisation and traceability requirements in their country.
Attribute	prescriptionTypeCode	PrescriptionTypeCode	0..*	Providing a value to this code list indicates the type of prescription that is required. The prescription type may indicate that it is a product that can only be prescribed under the direction of a specialist such as an oncologist, dentist, or other specialist.

Content	Attribute / Role	Datatype /Secondary class	Multiplicity	Definition
Attribute	usageDuringBreastFeedingCode	AllowedUsageCode	0..1	Indicates if the trade item can be used or not during breast feeding.
Attribute	usageDuringPregnancyCode	AllowedUsageCode	0..1	Indicates if the trade item can be used or not during pregnancy.

5.31 Lighting Device Module

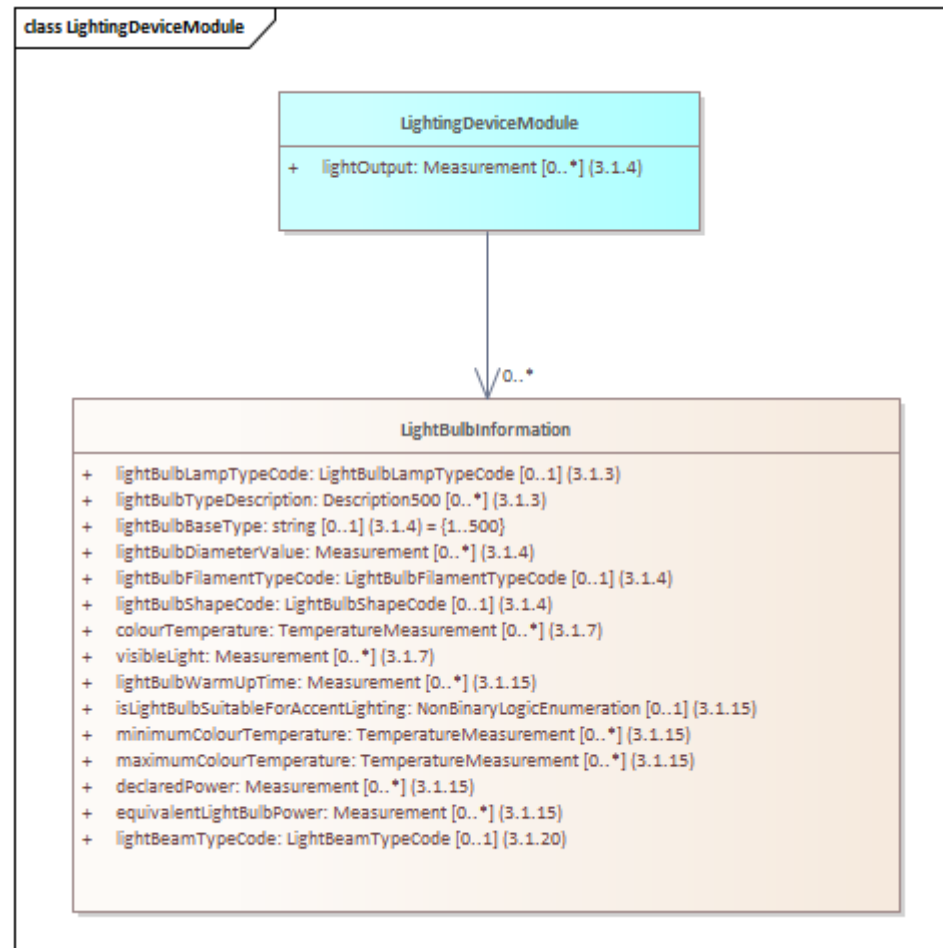

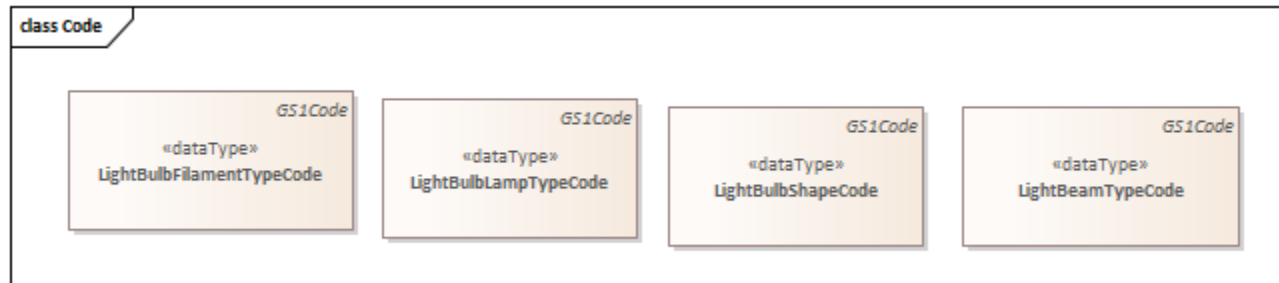

content	Attribute / Role	Datatype /Secondary class	Multipli city	Definition
LightBulbInformatio n				Information related to the capabilities and characteristics of light bulbs.
Attribute	colourTemperature	TemperatureMeasure ment	0..*	Colour temperature is a way to describe the light appearance provided by a light bulb for example 2700 KEL.
Attribute	declaredPower	Measurement	0..*	The declared power of a light bulb defines how much electricity the bulb can transform into light and heat over a given amount of time. If left on for one hour, a 25 Watt light bulb will use 25 Watt-hours (Wh) of energy.
Attribute	equivalentLightBulbP ower	Measurement	0..*	Indicates the equivalent light bulb power that is defined as the power of the replaced light bulb, if the light bulb is claimed to be equivalent to the replaced light bulb type.
Attribute	isLightBulbSuitableFo rAccentLighting	NonBinaryLogicEnum eration	0..1	Indicates the light bulb is suitable for accent lighting. For directional lamps only, and if the angle of the light beam of the lamp $\geq 90^\circ$ and its useful luminous flux must be measured in a cone of 120° .
Attribute	lightBeamTypeCode	LightBeamTypeCode	0..1	The code that specifies the type of light beam emitted by a light bulb.
Attribute	lightBulbBaseType	String	0..1	Light bulb sockets, lamp sockets or lamp holders provide electrical connections to the lighting fixture and support it in the lighting fixture. Examples: G4, G5, GU5.3, GU10, G13, Bi PiN T-3/4, Flanged T-3/4, BA75, BA95, BA150, BAY150, BA155, BA220.

content	Attribute / Role	Datatype /Secondary class	Multiplcity	Definition
Attribute	lightBulbDiameterValue	Measurement	0..*	The maximum diameter of the light bulb, either in 1/8 of an inch, or in millimetres, depending on the shape and the region. For example, 63 mm reflectors are designated R63, but in the US, they are known as R20 (2.5 in). However, in both regions, a PAR38 reflector is known as PAR38.
Attribute	lightBulbFilamentTypeCode	LightBulbFilamentTypeCode	0..1	The type of filament used in the light bulb. A filament is the threadlike conductor, often of tungsten, in the bulb that is heated to incandescence by the passage of current. Additional details on the types of light bulb filament types can be found on such sites as http://www.lightopedia.com/bases-filament-types .
Attribute	lightBulbShapeCode	LightBulbShapeCode	0..1	Light bulbs come in a range of shapes and sizes. The names of the shapes vary somewhat from region to region. Many of these shapes have a designation consisting of one or more letters followed by one or more numbers, e.g. A55 or PAR38. The letters represent the shape of the bulb. The numbers represent the maximum diameter, either in 1/8 of an inch, or in millimetres, depending on the shape and the region. For example, 63 mm reflectors are designated R63, but in the US, they are known as R20 (2.5 in). However, in both regions, a PAR38 reflector is known as PAR38. Additional details on light bulb shapes can be found at sites such as http://www.eaglelight.com/category/lighting_tutorials.bulb_shapes/ .
attribute	lightBulbLampTypeCode	LightBulbLampTypeCode	0..1	A code describing the type of light bulb whether it is the trade item or is contained in the trade item for example HALOGEN or LED.
attribute	lightBulbTypeDescription	Description500	0..*	A description of the type of light bulb whether it is the trade item or is contained in the trade item for example Incandescent or Halogen
Attribute	lightBulbWarmUpTime	Measurement	0..*	Indicates the maximum time in seconds the light bulb is warmed up to 60% of the full light output.
Attribute	maximumColourTemperature	TemperatureMeasurement	0..*	Indicates the maximum colour temperature that is a way to describe the maximum light appearance provided by a light bulb for example 2700 KEL.
Attribute	minimumColourTemperature	TemperatureMeasurement	0..*	Indicates the minimum colour temperature that is a way to describe the minimum light appearance provided by a light bulb for example 1800 KEL.

content	Attribute / Role	Datatype /Secondary class	Multipl city	Definition
Attribute	visibleLight	Measurement	0..*	Total quantity of visible light emitted by a light source for example 1200 LUM.
LightingDeviceModule				A module including attributes related to lighting devices such as lamps.
Association		LightBulbInformation	0..*	Light bulb information relating to a lighting device.
Attribute	lightOutput	Measurement	0..*	The amount of light a fixture produces and how the fixture emits and distributes that light. This is usually measured in lumens or lux for example 450 LUM.

5.32 Marketing Information Module

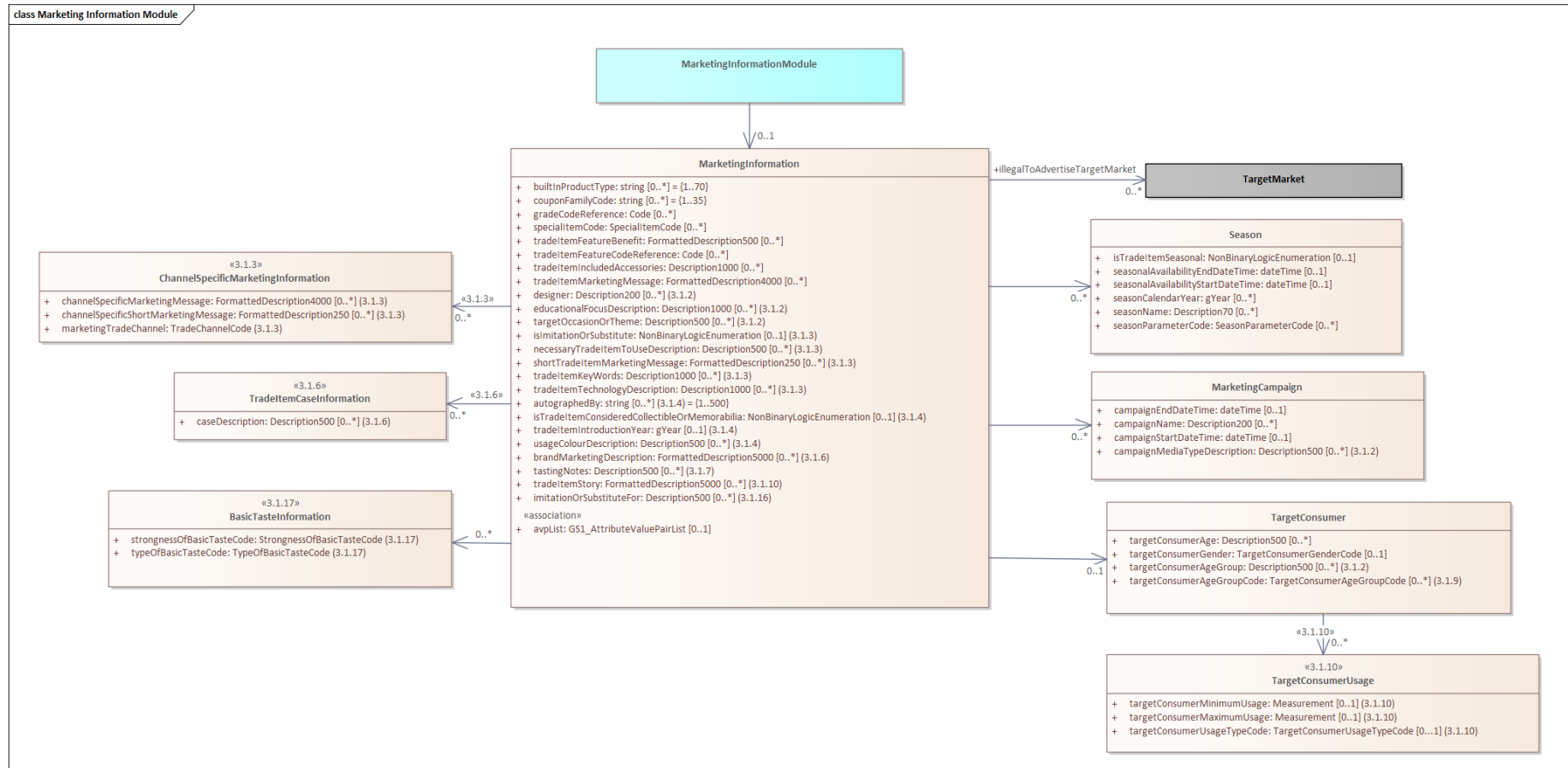

Note: Common class (in grey) is located in the GDSN Common Library.

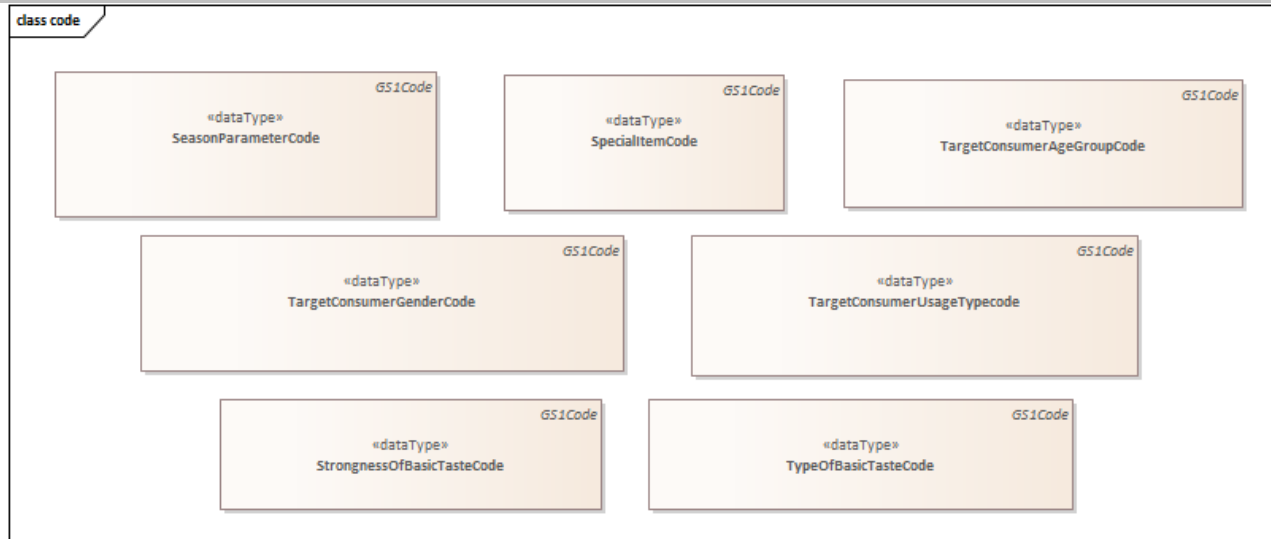

content	attribute / role	datatype /secondary class	multiplcity	definition
MarketingInforma tionModule				A module containing information on a trade item meant to convey features and benefits and targeted customer.
Association		MarketingInformati on	0..1	Information on a trade item meant to convey features and benefits and targeted customer.
BasicTasteInform ation				A group of attributes that describe a product's basic taste information
Attribute	strongnessOfBasicTas teCode	StrongnessOfBasic TasteCode	1..1	Indicates the descriptive term that is used by the product manufacturer to identify the strongness of basic taste of the product.
Attribute	typeOfBasicTasteCod e	TypeOfBasicTasteC ode	1..1	Indicates a basic taste of a product, and together with strongnessOfBasicTaste this indicates the level of the basic taste in a product.
MarketingInforma tion				Information on a trade item meant to convey features and benefits.
Association		ChannelSpecificMar ketingInformation	0..*	Provides marketing information that can differ per trade channel.

content	attribute / role	datatype /secondary class	multipl city	definition
Association		MarketingCampaign	0..*	Details on a sales or marketing campaign for a trade item.
Association	illegalToAdvertiseTargetMarket	TargetMarket	0..*	The target market where it is prohibited by law to advertise a trade item. An example of this is France where laxatives are illegal to advertise.
Association		TradeItemCaseInformation	0..*	Information on cases that come with a trade item.
Association		Season	0..*	Information on whether or not the trade item is only offered during certain parts of the year or targeted to different seasons.
Association		TargetConsumer	0..1	Target consumer details for a trade item.
Association	avpList	GS1_AttributeValuePairList	0..1	The transmission of non-standard data done in a simple, flexible, and easy to use method.
Attribute	autographedBy	String	0..*	The person's name who signed or autographed the trade item for example John Hancock.
Attribute	brandMarketingDescription	FormattedDescription5000	0..*	A marketing description which focuses on the brand of the trade item. For example the history of the brand.
Attribute	builtInProductType	string	0..*	The type of product that the trade item is combined with for example a VCR in the case that a television is combined with a VCR.
Attribute	couponFamilyCode	string	0..*	A code assigned by the vendor to a single trade item or to families of consumer trade items that can be used by in store scanners in conjunction with a U.P.C. coupon value code for coupon value discount when the proper trade item has been purchased.
attribute	designer	Description200	0..*	The person or company that designed the product. This may or may not be the brand name as designers. Guess jeans designers were Paul and Maurice Marciano.
attribute	educationalFocusDescription	Description1000	0..*	A description of the educational benefit the trade item is designed to provide for example: shape identification, language, motor skills, pretend play, color identification, science.
Attribute	gradeCodeReference	Code	0..*	A code indicating the degree of refinement, features, or capabilities for a trade item for example the quality grade of a ceramic tile or of a food item such as eggs.

content	attribute / role	datatype /secondary class	multiplcity	definition
Attribute	imitationOrSubstituteFor	Description500	0..*	The name of the imitated or substitute product. Example: The GTIN product name is Ketchup type sauce, this value would be Ketchup.
Attribute	isImitationOrSubstitute	NonBinaryLogicEnumeration	0..1	Determines whether the trade item is an imitation or substitute product resembling the real product for example imitation eggs or milk substitute non-dairy.
Attribute	isTradeItemConsideredCollectibleOrMemorabilia	NonbinaryLogicEnumeration	0..1	Is the trade item considered collectible by consumer or evokes memories to the end consumer.
Attribute	necessaryTradeItemToUseDescription	Description500	0..*	A description used to differentiate the stand alone trade items from the trade items that cannot be used on their own for example an add-on for SIMS video game or accessories for i-phone.
Attribute	shortTradeItemMarketingMessage	FormattedDescription250	0..*	A short marketing message associated to the Trade item.
Attribute	specialItemCode	SpecialItemCode	0..*	This element identifies specific items for promotional, purchase eligibility and/or special tracking
Attribute	tradeItemFeatureBenefit	FormattedDescription500	0..*	The description of features and benefits of the individual product, service, brand or seller.
attribute	targetOccasionOrTheme	Description500	0..*	The particular target time, event, theme, or holiday for the product for example Mother's Day, baby shower, birthday, etc.
attribute	tastingNotes	Description500	0..*	Written testimony about a products aroma, flavour, texture for example fruity.
Attribute	tradeItemFeatureCodeReference	Code	0..*	A code depicting a distinctive functionality offered as a special attraction to the trade item for example BUILT_IN_ALARM_CLOCK. Use FeatureCode.
Attribute	tradeItemIncludedAccessories	Description1000	0..*	Any included object or device not part of the core product itself but which adds to its functionality or use.
Attribute	tradeItemIntroductionYear	gYear	0..1	The date the GTIN and/or trade item is introduced into the marketplace. Once established this does not change.
Attribute	tradeItemMarketingMessage	FormattedDescription4000	0..*	Marketing message associated to the Trade item.
Attribute	tradeItemKeyWords	Description1000	0..*	Words or phrases that enables web search engines to find trade items on the internet for example Shampoo, Lather, Baby.
Attribute	tradeItemStory	FormattedDescription5000	0..*	Allows suppliers to tell the back story of the product and inform their consumers.

content	attribute / role	datatype /secondary class	multiplcity	definition
Attribute	tradeItemTechnologyDescription	Description1000	0..*	The type(s) of marketing name technologies contained in the appliance for example Smart Technology.
Attribute	usageColourDescription	Description500	0..*	A description of the usage of colour(s) the trade item offers such as pens, markers, ink pads, printer cartridges and other implements that provide colour. Examples include black, white.
ChannelSpecificMarketingInformation				Provides marketing information that can differ per trade channel.
Attribute	channelSpecificMarketingMessage	FormattedDescription4000	0..*	A marketing message for the trade item relating to a specific trade channel such as CONVENIENCE.
Attribute	channelSpecificShortMarketingMessage	FormattedDescription250	0..*	A short marketing message associated to the Trade item for a specific trade channel.
Attribute	marketingTradeChannel	TradeChannelCode	1..1	The trade channel associated with the marketing information.
MarketingCampaign				Details on a sales or marketing campaign for a trade item.
Attribute	campaignEndDateTime	dateTime	0..1	The date suggested by the supplier for the campaign to end. It indicates the end of a marketing campaign.
Attribute	campaignMediaTypeDescription	Description500	0..*	Describes the type of advertising mechanism, example TV, radio, magazine, newspaper.
Attribute	campaignName	Description200	0..*	Name of the sales or marketing campaign, for which the trade item is intended. Input of user-defined text in order to assign the item to a specific marketing campaign.
Attribute	campaignStartTime	dateTime	0..1	The date suggested by the supplier for the campaign to start. It indicates the beginning of a marketing campaign.
Season				Information on whether or not the trade item is only offered during certain parts of the year or targeted to different seasons.
Attribute	isTradeItemSeasonal	NonBinaryLogicEnumeration	0..1	An indicator whether or not the trade item is only offered during certain parts of the year or targeted to different seasons.
Attribute	seasonalAvailabilityEndTime	dateTime	0..1	Indicates the end date of the trade item's seasonal availability.
Attribute	seasonalAvailabilityStartTime	dateTime	0..1	Indicates the start date of the trade item's seasonal availability.
Attribute	seasonCalendarYear	gYear	0..*	This element indicates the calendar year in which the trade item is seasonally available.

content	attribute / role	datatype /secondary class	multiplcity	definition
Attribute	seasonName	Description70	0..*	Element defines the season applicable to the item.
Attribute	seasonParameterCode	SeasonParameterCode	0..*	Indication of the season, in which the trade item is available, i.e. assignment to one of the following collection periods: spring/summer, autumn/ winter or all year around.
TargetConsumer				The type of consumer the trade item is marketed towards for example gender or age.
Attribute	targetConsumerAge	Description500	0..*	Identifies the target consumer age range for which a trade item has been designed.
Attribute	targetConsumerAgeGroup	Description500	0..*	A description of a general age group the product is designed for. This would not include the actual age ranges. For example Infant, Toddler, Child, Teen, Adult.
Attribute	targetConsumerGender	TargetConsumerGenderCode	0..1	Identifies the target consumer gender for which a product has been designed.
Attribute	targetConsumerAgeGroupCode	TargetConsumerAgeGroupCode	0..*	A code depicting the general age group the product is designed for example BABY.
Association		TargetConsumerUsage	0..*	The type of consumer usage.
Attribute	targetConsumerMinimumUsage	Measurement	0..1	Measurement of the minimum usage criteria for the target consumer that will use the product for example minimum age, height, etc.
Attribute	targetConsumerMaximumUsage	Measurement	0..1	Measurement of the maximum usage criteria for the target consumer that will use the product for example maximum age, height, etc.
Attribute	targetConsumerUsageTypeCode	TargetConsumerUsageTypecode	0..1	A code identifying the type of usage criteria for the target consumer that will use the product for example AGE, HEIGHT.
TradeItemCaseInformation				Information on any case that is included with a trade item for example material, size, features.
Attribute	caseDescription	Description500	0..*	Describes the shape and characteristics of the case the trade item will be inside. For example watches come in unique cases. Examples include leather bound case, designer matching case, velvet lined box.

5.33 Material Module

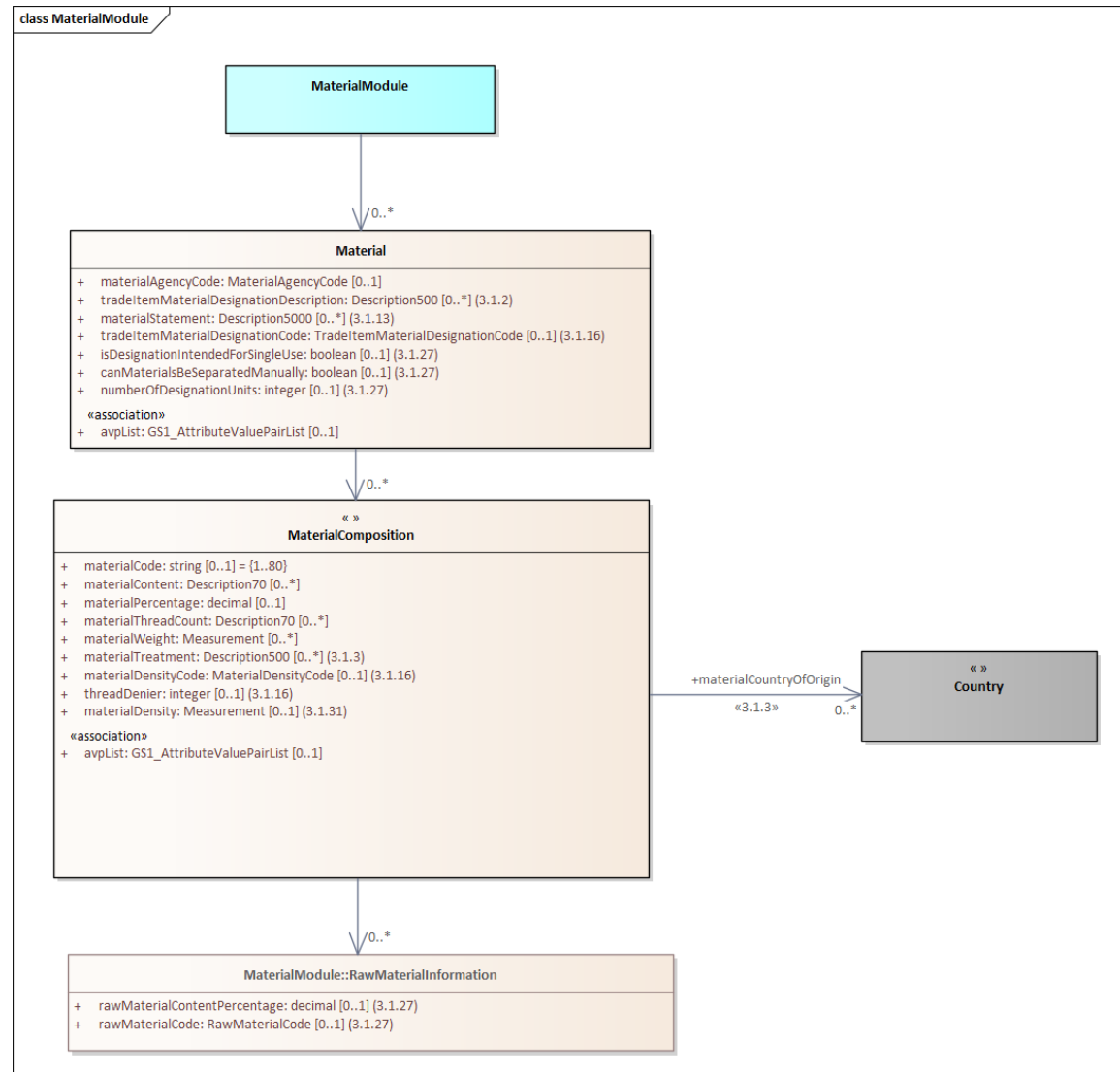

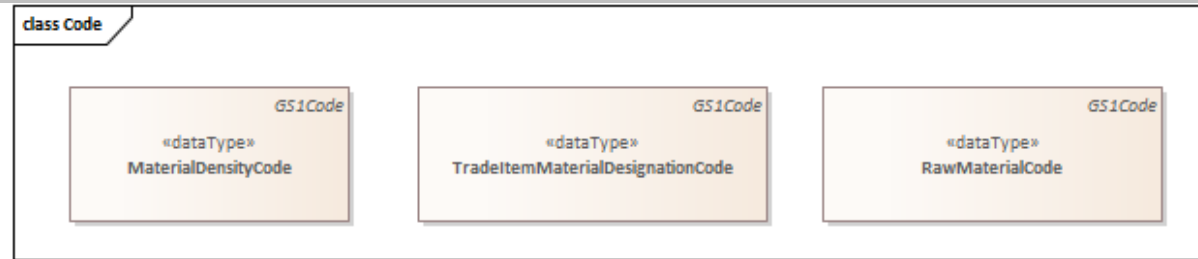

content	attribute / role	datatype /secondary class	multiplicity	definition
MaterialModule				A module expressing details on the composition of any materials used to make a trade item using textiles for example clothing or furniture.
Material				Details on the composition of any materials used to make a trade item using textiles.
Association		MaterialComposition	0..*	Details on the composition of any materials used to make a trade item.
Attribute	tradeItemMaterialDesignationDescription	Description500	0..*	The description of the element or place on the trade item, that the material information is being described for example: filling, outer, eyes, trim.
Association	avpList	GS1_AttributeValuePairList	0..1	Attribute value pair information.
Attribute	materialAgencyCode	MaterialAgencyCode	0..1	This element indicates the agency that is maintaining the Trade Item Material codes. This may include a specific code list.
Attribute	isDesignationIntendedForSingleUse	Boolean	0..1	The indicator that specifies whether the product or packaging is disposable and intended to only be used once before being thrown away or recycled.
Attribute	canMaterialsBeSeparatedManually	Boolean	0..1	The indicator that specifies whether the packaging materials can be separated manually without the help of tools.
Attribute	numberOfDesignationUnits	Integer	0..1	The number of designation units in the product that the material is associated to.
Attribute	tradeItemMaterialDesignationCode	TradeItemMaterialDesignationCode	0..1	Code indicating the part of the trade item that the material attributes are associated to.
Attribute	materialStatement	Description5000	0..*	Used to indicate the materials that are used in durable products. Material Statement is written as it is on the product or its label.
MaterialComposition				Details on the composition of any materials used to make the trade item.

content	attribute / role	datatype /secondary class	multiplicity	definition
Attribute	materialCode	string	0..1	This element indicates the product material code that gives the composition of the trade item's first main material up to six material short codes that can be given in descending order of their respective percentages.
Attribute	materialContent	Description70	0..*	This element is used to indicate the material composition. This element is used in conjunction with the percentage.
Attribute	materialDensity	Measurement	0..1	The density of the material expressed as its mass per unit volume, e.g., kilograms per cubic metre or pounds per cubic foot.
Attribute	materialDensityCode	MaterialDensityCode	0..1	A code that specifies the weight and thickness of the material.
Attribute	materialPercentage	Decimal	0..1	Net weight percentage of a product material of the first main material. The percentages must add up to 100.
Attribute	materialThreadCount	Description70	0..*	This element is used to specify the quality of material (fabric) of a trade item.
Attribute	materialWeight	Measurement	0..*	The measured weight of the material.
Attribute	materialTreatment	Description500	0..*	Indicates how the material is treated for example natural (un-treated), painted, dyed, bleach, coloured, etc.
Association	materialCountryOfOrigin	Country	0..*	The country from which the material was sourced for production purposes.
Attribute	threadDenier	integer	0..1	Denier is a measurement for fabric and threads. It is the mass in grams per 9,000 meters (9 kilometres) of the fibre/thread. The denier is based on a natural reference: a single strand of silk is approximately one denier; a 9000-meter strand of silk weighs about one gram (1 denier= 1 g / 9000 m).
RawMaterialInformation				A set of attributes describing the raw material(s) information of a particular product material
Attribute	rawMaterialContentPercentage	Decimal	0..1	The percentage of the type of raw or recycled material the product material is made from, as specified by the Raw Material Code.
Attribute	rawMaterialCode	RawMaterialCode	0..1	The code describing the type of raw or recycled material the product material is made from.
Association	avpList	GS1_AttributeValuePairList	0..1	Attribute value pair information.

5.34 Medical Device Trade Item Module

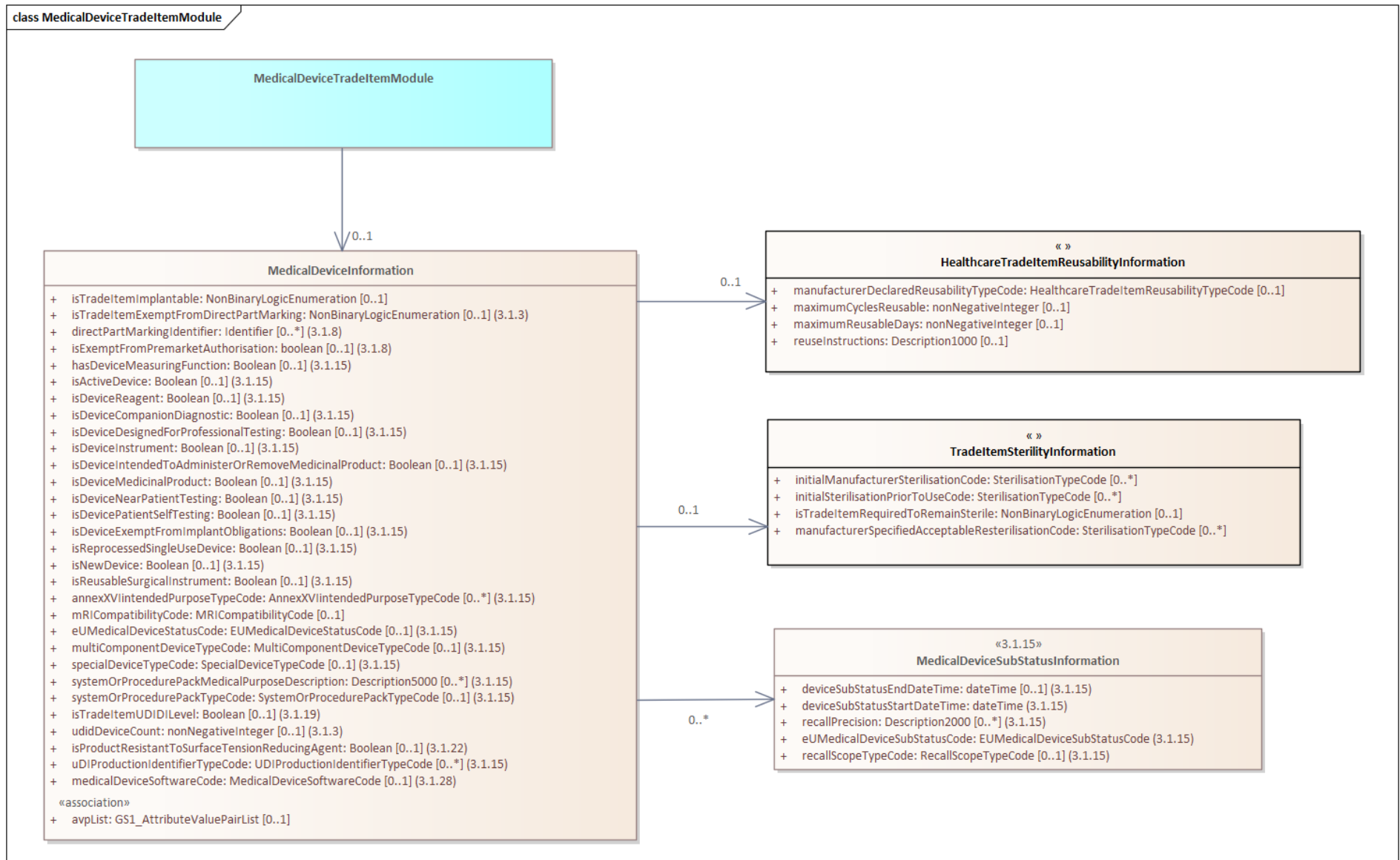



content	attribute / role	datatype /secondary class	multiplcity	definition
MedicalDeviceTradeItemModule				A module containing information on medical device and in vitro diagnostic trade items.
Association		MedicalDeviceInformation	0..1	Information on medical device and in vitro diagnostic trade items.
MedicalDeviceInformation				Information on medical device trade items.

content	attribute / role	datatype /secondary class	multiplcity	definition
MedicalDeviceTradeItemModule				A module containing information on medical device and in vitro diagnostic trade items.
Association		MedicalDeviceInformation	0..1	Information on medical device and in vitro diagnostic trade items.
Association		TradeItemSterilityInformation	0..1	Information regarding sterility of Healthcare trade items.
Association		HealthCareTradeItemReusabilityInformation	0..1	Provides the ability to specify details about the reusability of a healthcare trade item.
Association		MedicalDeviceSubStatusInformation	0..*	Group of attributes to denote the market sub-status of a Medical Device
Association	avpList	GS1_AttributeValuePairList	0..1	The transmission of non-standard data done in a simple, flexible, and easy to use method.
Attribute	annexXVIIntendedPurposeTypeCode	AnnexXVIIntendedPurposeTypeCode	0..*	All intended purposes other than for medical uses which apply to the product (EUDAMED Annex XVI).
Attribute	directPartMarkingIdentifier	Identifier	0..*	A number or marking placed directly on the medical device for example DLC-2200.
Attribute	eUMedicalDeviceStatusCode	EUMedicalDeviceStatusCode	0..1	The market status of the medical device for the EU Market. Example: On the Market, No Longer Placed on the Market.
Attribute	hasDeviceMeasuringFunction	Boolean	0..1	Indication if the device has a function which measures any type of patient metrics.
Attribute	isActiveDevice	Boolean	0..1	Indication if the Basic UDI-DI (Global Model Number) is an Active device. 'Active' means any device, the operation of which depends on a source of energy other than that generated by the human body for that purpose, or by gravity, and which acts by changing the density of or converting that energy. Devices intended to transmit energy, substances or other elements between an active device and the patient, without any significant change, shall not be deemed to be active devices. Software shall also be deemed to be an active device.
Attribute	medicalDeviceSoftwareCode	MedicalDeviceSoftwareCode	0..1	The code that identifies if the medical device is itself software, or if the device contains software.

content	attribute / role	datatype /secondary class	multipl city	definition
MedicalDeviceTradeItemModule				A module containing information on medical device and in vitro diagnostic trade items.
Association		MedicalDeviceInformation	0..1	Information on medical device and in vitro diagnostic trade items.
Attribute	isDeviceCompanionDiagnostic	Boolean	0..1	Indication the device has a role as a Companion Diagnostic. 'Companion diagnostic' means a device which is essential for the safe and effective use of a corresponding medicinal product to: <ul style="list-style-type: none"> - identify, before and/or during treatment, patients who are most likely to benefit from the corresponding medicinal product - identify, before and/or during treatment, patients likely to be at increased risk of serious adverse reactions as a result of treatment with the corresponding medicinal product.
Attribute	isDeviceDesignedForProfessionalTesting	Boolean	0..1	Indication the device is designed to be used for Professional Testing. Professional testing are tests to be conducted by a medical professional and not by a patient themselves.
Attribute	isDeviceExemptFromImplantObligations	Boolean	0..1	Indication the medical device is exempted from specific obligations imposed on implantable devices by the regulation. Refer to EU MDR Article 18/3 Implant Card and Information to be supplied to the patient with an implanted device.
Attribute	isDeviceInstrument	Boolean	0..1	Indication the device is an Instrument to be used in a procedure.
Attribute	isDeviceIntendedToAdministerOrRemoveMedicinalProduct	Boolean	0..1	Indication the device is intended to administer or remove medicinal product.
Attribute	isDeviceMedicinalProduct	Boolean	0..1	Indication the device contains substances which may be considered medicinal product.
Attribute	isDeviceNearPatientTesting	Boolean	0..1	Indication the device is for Near Patient testing. 'Device for near-patient testing' means the device is not intended for self-testing but is intended to perform testing outside a laboratory environment, generally near to, or at the side of, the patient by a health professional.

content	attribute / role	datatype /secondary class	multipl city	definition
MedicalDeviceTradeItemModule				A module containing information on medical device and in vitro diagnostic trade items.
Association		MedicalDeviceInformation	0..1	Information on medical device and in vitro diagnostic trade items.
Attribute	isDevicePatientSelfTesting	Boolean	0..1	Indication the device is for self patient testing. 'Device for self-testing' means any device intended by the manufacturer to be used by lay persons, including devices used for testing services offered to lay persons by means of information society services.
Attribute	isDeviceReagent	Boolean	0..1	Indication the device is a reagent.
Attribute	isNewDevice	Boolean	0..1	Indication that the product is considered a new device in the European Union market. A device shall be considered to be 'new' if: (a) there has been no such device continuously available on the EU market during the previous three years for the relevant analyte or other parameter; (b) the procedure involves analytical technology not continuously used in connection with a given analyte or other parameter on the Union market during the previous three years. EU IVDR Annex VI a 2.13
Attribute	isProductResistantToSurfaceTensionReducingAgent	Boolean	0..1	The indicator that specifies whether the product is resistant to a surface tension reducing agent.
Attribute	isReprocessedSingleUseDevice	Boolean	0..1	Indication the device is a single use device which has been Reprocessed. Rules for reprocessing are governed by local market regulations.
Attribute	isReusableSurgicalInstrument	Boolean	0..1	Indication the device is a Reusable Surgical Instrument. 'Reusable surgical instrument' means an instrument intended for surgical use in cutting, drilling, sawing, scratching, scraping, clamping, retracting, clipping or similar procedures, without a connection to an active device and which is intended by the Manufacturer to be reused after appropriate procedures such as cleaning, disinfection and sterilisation have been carried out.

content	attribute / role	datatype /secondary class	multiplcity	definition
MedicalDeviceTradeItemModule				A module containing information on medical device and in vitro diagnostic trade items.
Association		MedicalDeviceInformation	0..1	Information on medical device and in vitro diagnostic trade items.
Attribute	isExemptFromPremarketAuthorisation	NonBinaryLogicEnumeration	0..1	Indicates whether the medical device is exempt from premarket regulations. For the FDA, Premarket approval (PMA) is the process of scientific and regulatory review to evaluate the safety and effectiveness of Class III medical devices. Class III devices are those that support or sustain human life, are of substantial importance in preventing impairment of human health, or which present a potential, unreasonable risk of illness or injury. Due to the level of risk associated with Class III devices, FDA has determined that general and special controls alone are insufficient to assure the safety and effectiveness of class III devices. Therefore, these devices require a premarket approval (PMA) application under section 515 of the FD&C Act in order to obtain marketing clearance. Please note that some Class III preamendment devices may require a Class III 510(k).
Attribute	isTradeItemExemptFromDirectPartMarking	NonBinaryLogicEnumeration	0..1	Indicator signifying the trade item is exempt from direct identification marking according to regulation or regulatory filings within the target market.
Attribute	isTradeItemImplantable	NonBinaryLogicEnumeration	0..1	Implantable devices are defined as devices that are partly or totally inserted into the human body, as determined by local regulations.
Attribute	isTradeItemUDIDLevel	Boolean	0..1	An indicator used in the context of medical device trade item hierarchies. It signifies that the identifier (GTIN) of the trade item is the access key to the device's record in Unique Device Identification Databases.
Attribute	mRICompatibilityCode	MRICompatibilityCode	0..1	This is an identification of the compatibility of a trade item for use in the presence of a Magnetic Resonance Imaging (MRI) system.
Attribute	multiComponentDeviceTypeCode	MultiComponentDeviceTypeCode	0..1	The device is either a system which is a device in itself, a procedure pack which is a device in itself or kit (only applicable in case of IVDR Devices). This is applicable for standard devices (not systems or procedure packs). For example in the EU (in accordance with the Art. 22(4) MDR).

content	attribute / role	datatype /secondary class	multiplcity	definition
MedicalDeviceTradeItemModule				A module containing information on medical device and in vitro diagnostic trade items.
Association		MedicalDeviceInformation	0..1	Information on medical device and in vitro diagnostic trade items.
Attribute	specialDeviceTypeCode	SpecialDeviceTypeCode	0..1	The type of special medical device the product is. Example: Orthopaedic, Rigid Gas Permeable (RGP) & Made-to-Order Soft Contact Lenses, Software
Attribute	systemOrProcedurePackMedicalPurposeDescription	Description5000	0..*	Descriptive terms to denote the Medical Purpose of the System or Procedure Pack. Applicable for System and Procedure Packs and refers to the indication of the specific medical purpose of the System or Procedure Pack.
Attribute	systemOrProcedurePackTypeCode	SystemOrProcedurePackTypeCode	0..1	The Medical Device is a System or Procedure Pack as defined by Target Market rules.
Attribute	udidDeviceCount	nonNegativeInteger	0..1	The count of medical devices which are contained inside the base item for regulatory purposes." This information is part of the UDID regulatory requirements and would be populated at the lowest level of a hierarchy. Device count is not the same as net content as a single device can contain multiple uses.
Attribute	uDIProductionIdentifierTypeCode	UDIProductionIdentifierTypeCode	0..*	The Production Identifiers which are used to control the product as relevant for Unique Device Identification (UDI) rules. Example: Expiry Date, Manufacturing Date, Serial Number, Lot (or batch) Number, etc.
MedicalDeviceSubStatusInformation				Group of attributes to denote the market sub-status of a Medical Device
Attribute	deviceSubStatusEndDateTime	DateTime	0..1	The date time when the sub-status of the medical device ends for the EU Market.
Attribute	deviceSubStatusStartDateTime	DateTime	1..1	The date time when the sub-status of the medical device begins for the EU Market.
Attribute	eUMedicalDeviceSubStatusCode	EUMedicalDeviceSubStatusCode	1..1	The market sub-status of the medical device for the EU Market. Example: Field Safety Corrective Action (FSCA), Recall.

content	attribute / role	datatype /secondary class	multiplcity	definition
MedicalDeviceTradeItemModule				A module containing information on medical device and in vitro diagnostic trade items.
Association		MedicalDeviceInformation	0..1	Information on medical device and in vitro diagnostic trade items.
Attribute	recallPrecision	Description2000	0..*	The precision of the Recall or Field Safety Corrective Action (FSCA). Information about the Recall of FSCA should include the details of the recalled elements (batch numbers, lots numbers , etc.) of the Device. This information is applicable when the scope of a recall is entered manually by the user (not by referencing an Field Safety Notice (FSN))
Attribute	recallScopeTypeCode	RecallScopeTypeCode	0..1	The scope of the Recall or FSCA. Example: Brain electrostimulation, Contact Lenses, etc.
HealthcareTradeItemReusabilityInformation				Provides the ability to specify details about the reusability of a healthcare trade item.
Attribute	manufacturerDeclaredReusabilityTypeCode	HealthcareTradeItemReusabilityTypeCode	0..1	Determines if the product is intended for single or multiple uses, including the number of validated cycles and the number of times a product can be used according to the manufacturer specifications. It is suggested that medical providers consult the device manufacturer's Instruction For Use (IFU) for full reusability instructions.
Attribute	maximumCyclesReusable	nonNegativeInteger	0..1	Maximum number of times this Trade Item can be reused.
Attribute	maximumReusableDays	nonNegativeInteger	0..1	The maximum number of days this product can be reused based upon the re-use instructions, local regulations or other manufacturer documentation.
Attribute	reuseInstructions	Description1000	0..1	Additional instructions that advise the customer on the reusability limitations of this product.
TradeItemSterilityInformation				Information regarding sterility of Healthcare trade items.

content	attribute / role	datatype /secondary class	multipl city	definition
MedicalDeviceTradeItemModule				A module containing information on medical device and in vitro diagnostic trade items.
Association		MedicalDeviceInformation	0..1	Information on medical device and in vitro diagnostic trade items.
Attribute	initialManufacturerSterilisationCode	SterilisationTypeCode	0..*	Declaration of sterilisation, including not sterilised, which may have been performed by the manufacturer. Sterilisation refers to any process that effectively kills or eliminates transmissible agents (such as fungi, bacteria, viruses, prions and spore forms etc.) from a surface, equipment, foods, medications, or biological culture medium. Some methods of sterilization are through the application of heat, radiation, and ethylene.
Attribute	initialSterilisationPriorToUseCode	SterilisationTypeCode	0..*	This is an indication of the type(s) of sterilisation that is required to be completed by a healthcare provider prior to initial use of the healthcare trade item. Sterilisation refers to any process that effectively kills or eliminates transmissible agents (such as fungi, bacteria, viruses, prions and spore forms etc.) from a surface, equipment, foods, medications, or biological culture medium. Some methods of sterilisation are through the application of heat, radiation, and ethylene.
Attribute	isTradeItemRequiredToRemainSterile	NonBinaryLogicEnumeration	0..1	An indication that the products sterile status must be maintained from the point in time of sterilisation until point of administration.
Attribute	manufacturerSpecifiedAcceptableResterilisationCode	SterilisationTypeCode	0..*	This is a list of the type(s) of acceptable sterilisation that a reusable trade item can undergo by a healthcare provider if a trade item is reusable. Sterilisation refers to any process that effectively kills or eliminates transmissible agents (such as fungi, bacteria, viruses, prions and spore forms etc.) from a surface, equipment, foods, medications, or biological culture medium. Some methods of sterilisation are through the application of heat, radiation, and ethylene.

5.35 Movie Revenue Information Module

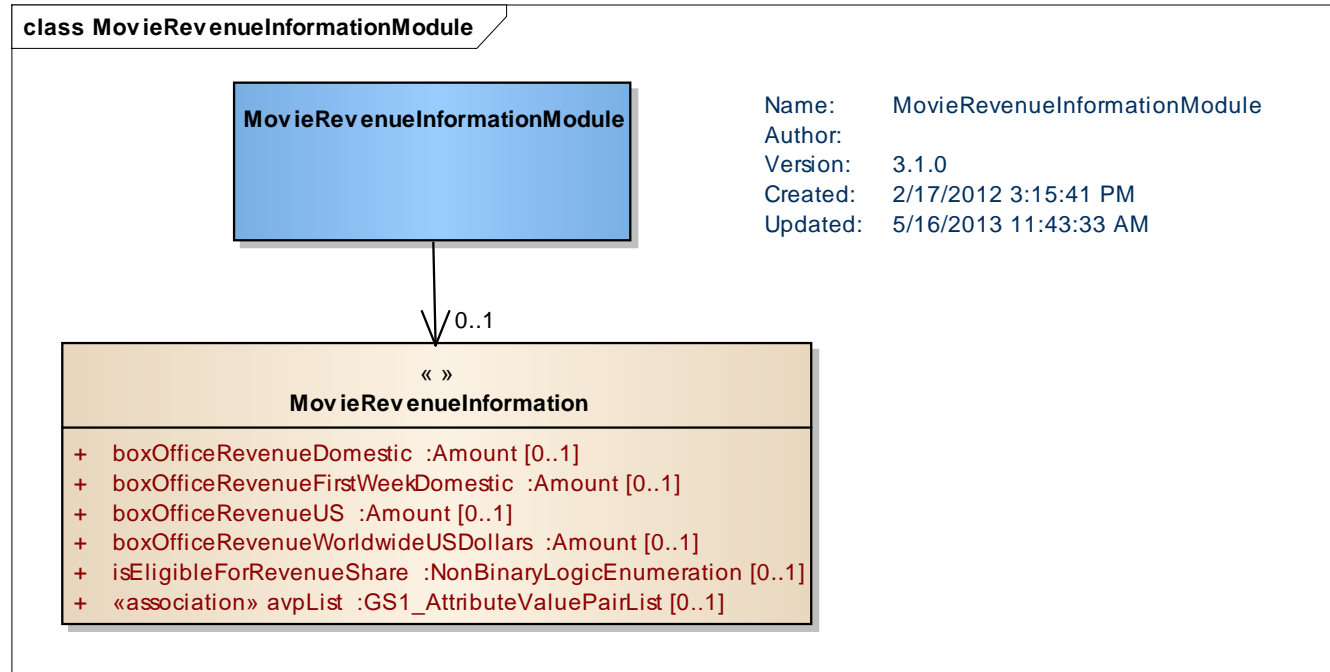

Content	Attribute / Role	Datatype /Secondary class	Multiplicity	Definition
MovieRevenueInformationModule				A module containing attributes relating to the revenue of a film.
Association		MovieRevenueInformation	0..1	Logical grouping of attributes relating to the revenue of a film.
MovieRevenueInformation				Logical grouping of attributes relating to the revenue of a film.
Association	avpList	GS1_AttributeValuePairList	0..1	The transmission of non-standard data done in a simple, flexible, and easy to use method.

Content	Attribute / Role	Datatype /Secondary class	Multiplicity	Definition
Attribute	boxOfficeRevenueDomestic	Amount	0..1	The revenue the film earned on the target market expressed in local currency.
Attribute	boxOfficeRevenueFirstWeek Domestic	Amount	0..1	The revenue the film earned on the target market for the first week expressed in local currency.
Attribute	boxOfficeRevenueUS	Amount	0..1	The revenue the film earned on the US market expressed in US dollars.
Attribute	boxOfficeRevenueWorldwideUSDollars	Amount	0..1	The revenue the film earned on all the markets expressed in US dollars.the revenue the film earned on all the markets expressed in US dollars.
Attribute	isEligibleForRevenueShare	NonBinaryLogic Enumeration	0..1	A boolean that indicates if the film is available for revenue share or not.

5.36 Nonfood Ingredient Module

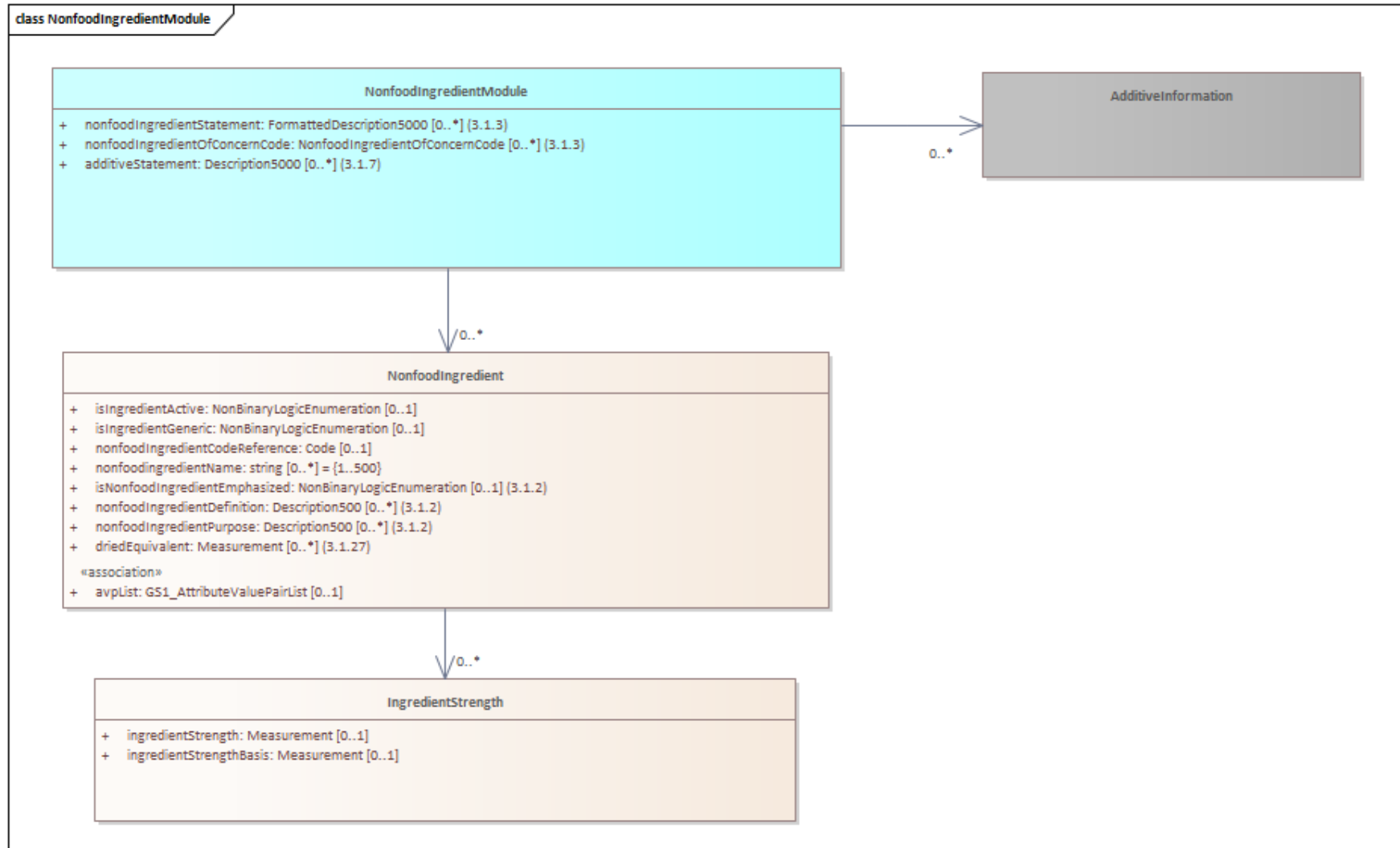

 **Note:** Common class (in grey) is located in the GDSN Common Library.

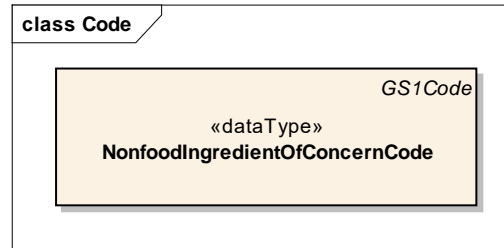

content	attribute / role	datatype /secondary class	multiplcity	definition
NonfoodIngredient				Information on ingredients for items that are not food for example detergents, medicines.
Association	avpList	GS1_AttributeValuePairList	0..1	The transmission of non-standard data done in a simple, flexible, and easy to use method.
association		IngredientStrength	0..*	Information on the strength of a nonfood ingredient.
Attribute	isIngredientActive	NonBinaryLogicEnumeration	0..1	Determines whether the ingredient helps directly in achieving the objectives of the trade item.
Attribute	isIngredientGeneric	NonBinaryLogicEnumeration	0..1	Determines whether the ingredient is classified as being generic.
Attribute	isNonfoodIngredientEmphasized	NonBinaryLogicEnumeration	0..1	Denotes the nonfood ingredient that should have its text emphasised in some fashion on the item's packaging.
Attribute	nonfoodIngredientCodeReference	Code	0..1	A code from a specific code list for a nonFood ingredient.
Attribute	nonfoodIngredientDefinition	Description500	0..*	A definition associated with the value in the nonfoodIngredientName. The definition should explain to the end user what the nonfood ingredient is.
Attribute	nonfoodIngredientName	String	0..*	The name of the non-food ingredient for example ammonia.
Attribute	nonfoodIngredientPurpose	Description500	0..*	A description of the primary purpose that an ingredient serves for example for sunscreen the ingredient may have the purpose of being a UVB Blocker.

content	attribute / role	datatype /secondary class	multiplcity	definition
Attribute	driedEquivalent	Measurement	0..*	The equivalent quantity amount of dried ingredient to an ingredient found in the product. The determination of this is made by the supplier and is subject to target market regulations or trade organization guidelines.
NonfoodIngredientModule				A module providing Information on ingredients for items that are not food for example detergents, medicines.
Association		NonfoodIngredient	0..*	Information on ingredients for items that are not food for example detergents, medicines.
Association		AdditiveInformation	0..*	Information on presence or absence of additives or genetic modifications contained in the trade item.
Attribute	additiveStatement	Description5000	0..*	Statement on presence or absence of additives or genetic modification contained in the trade item for example "Contains no preservatives, no artificial colours or flavours and no artificial flavours".
Attribute	nonfoodIngredientStatement	FormattedDescription5000	0..*	Information on the constituent ingredient make-up of the product as specified for non-food items.
Attribute	nonfoodIngredientOfConcernCode	NonfoodIngredientOfConcernCode	0..*	Specifies a non-food ingredient of concern for a trade item as a code.
IngredientStrength				Information on the strength of a nonfood ingredient.
Attribute	ingredientStrength	Measurement	0..1	Used to define the strength of each ingredient in a trade item or unit volume of non-food trade items.
Attribute	ingredientStrengthBasis	Measurement	0..1	The basis amount for an ingredient strength for example 1000 millilitres in the case of 400 milligrams per 1000 millilitres.

5.37 NonGTIN Logistics Unit Information Module

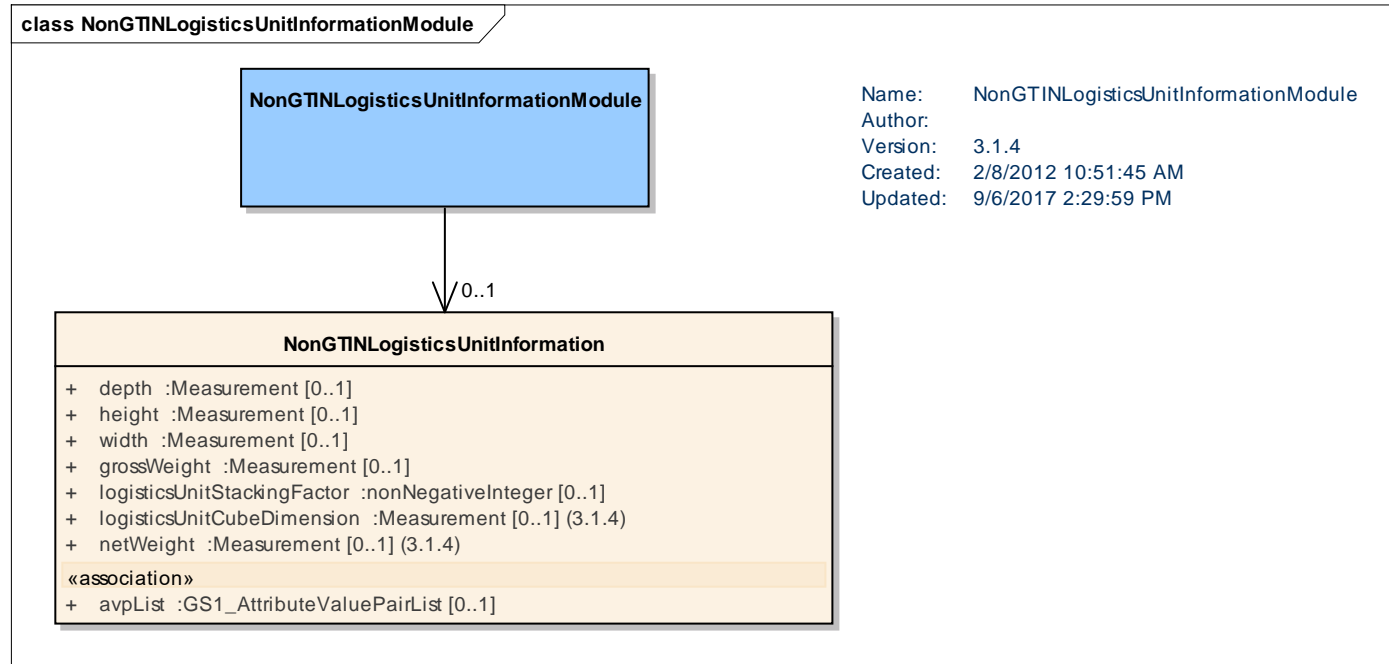

content	attribute / role	datatype /secondary class	multipl city	definition
NonGTINLogisticsUnitInformationModule				A module detailing information on a logistics item without a GTIN.
Association		NonGTINLogisticsUnitInformation	0..1	Details on a logistics item without a GTIN.
NonGTINLogisticsUnitInformation				Details on a logistics item without a GTIN.
Association	avpList	GS1_AttributeValuePairList	0..1	The transmission of non-standard data done in a simple, flexible, and easy to use method.

content	attribute / role	datatype /secondary class	multipl city	definition
Attribute	depth	Measurement	0..1	The depth of the unit load, as measured according to the GS1 Package and Product Measurement Standard, including the shipping platform unless it is excluded according to the platformTypeCode chosen.
Attribute	height	Measurement	0..1	The height of the unit load, as measured according to the GS1 Package and Product Measurement Standard, including the shipping platform unless it is excluded according to the platformTypeCode chosen.
Attribute	grossWeight	Measurement	0..1	The weight of both the unit load (content) and the platform upon which the goods are carried if there is one.
Attribute	logisticsUnitCubeDimension	Measurement	0..1	The dimensions of an imaginary cube which can be drawn around both the unit load (content) and the platform upon which the goods are carried if there is one, as defined in the formula of H X W X D (the linear dimensions multiplied to get a cubic result).
Attribute	netWeight	Measurement	0..1	The weight of both the unit load (content) and the platform upon which the goods are carried if there is one, excluding all packaging materials.
Attribute	width	Measurement	0..1	The width of the unit load, as measured according to the GS1 Package and Product Measurement Standard, including the shipping platform unless it is excluded according to the platformTypeCode chosen.
Attribute	logisticsUnitStackingFactor	nonNegativeInteger	0..1	The stacking factor of both the unit load (content) and the platform upon which the goods are carried, if there is one. A stacking factor determines the maximum stacking for the product. Indicates the number of levels the product may be stacked.

5.38 Nutritional Information Module

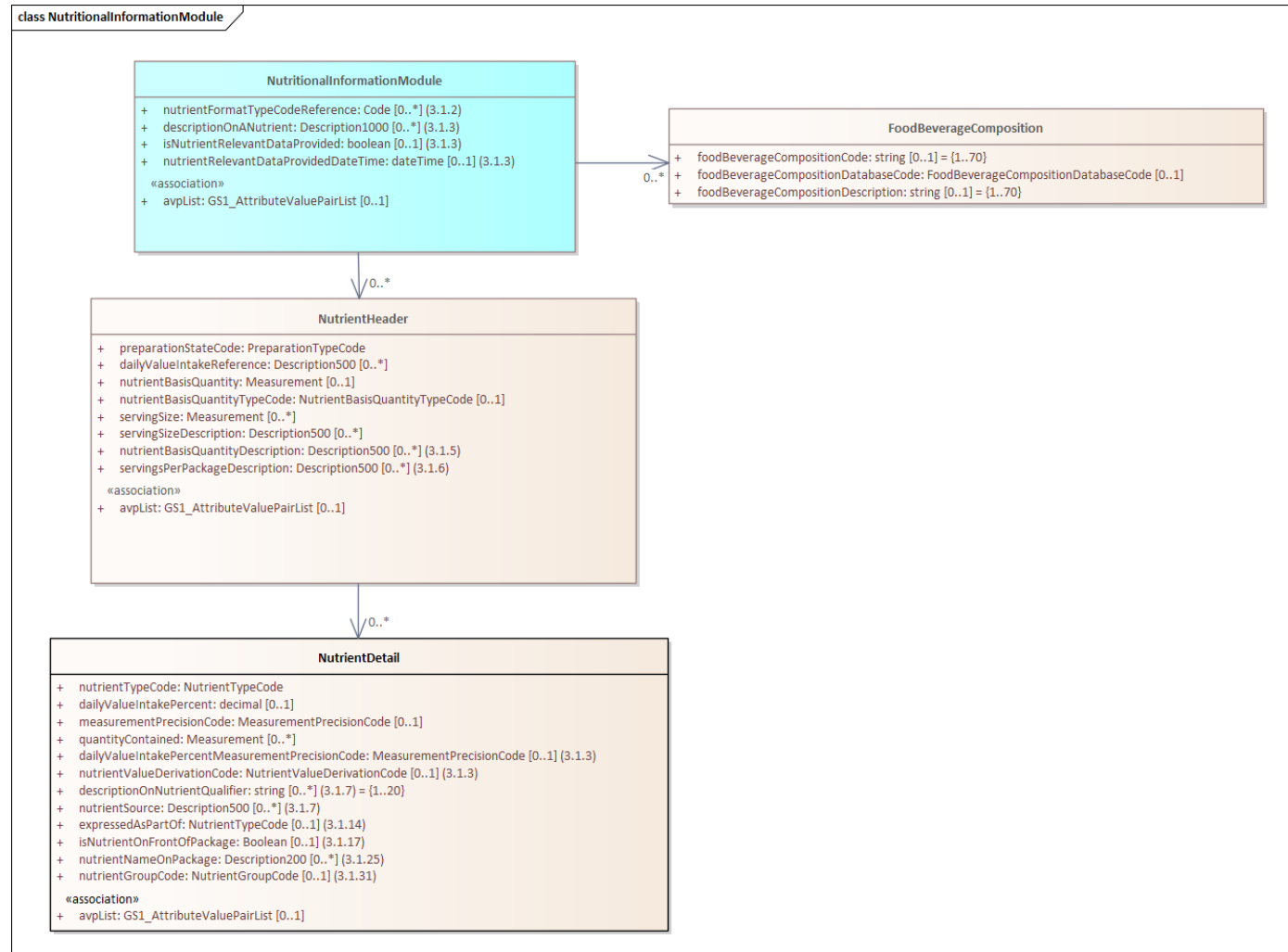

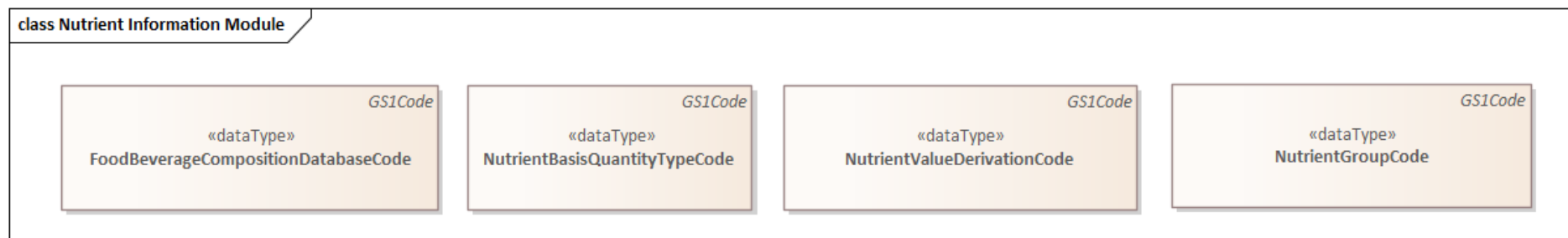

content	attribute / role	datatype /secondary class	multiplcity	definition
FoodBeverageComposition				Information on the nutritional composition of foods and beverages from food composition databases.
Attribute	foodBeverageCompositionCode	string	0..1	A value assigned by the agency for the lookup of food composition information that applies to regulatory nutrition information e.g. R851011.
Attribute	foodBeverageCompositionDatabaseCode	FoodBeverageCompositionDatabaseCode	0..1	A code depicting an agency which manages a food composition database that applies to regulatory nutrition information, for example, the Government of Canada.
Attribute	foodBeverageCompositionDescription	string	0..1	A text description of either the associated value or the actual database entry lookup for example chicken soup clear instant.
NutritionalInformationModule				Information about content of nutrients. Multiple sets of nutrient information can be specified with varying state, serving size and daily value intake base.
Attribute	nutrientFormatTypeCodeReference	Code	0..*	Specifies how nutrition information is displayed or provided for each prepackaged food for different nutrition layouts for example NFT.
Attribute	descriptionOnANutrient	Description1000	0..*	Any description on a nutrient which can not expressed by using in INFOODS code value.
Attribute	isNutrientRelevantDataProvided	boolean	0..1	Nutrient Information is populated for those values which are relevant or required to be populated on the product label or label equivalent. All values not populated are not relevant or not required to be populated on the product label by local regulations.

content	attribute / role	datatype /secondary class	multipl city	definition
Attribute	nutrientRelevantDataProvidedDateTim e	dateTime	0..1	The date upon which the isNutrientRelevantDataProvided indicator was last updated.
Association	avpList	GS1_AttributeValu ePairList	0..1	The transmission of non-standard data done in a simple, flexible, and easy to use method.
Association		NutrientHeader	0..*	Nutrient information for a trade item.
Association		FoodBeverageCom position	0..*	Information on the nutritional composition of foods and beverages from food composition databases.
NutrientHeader				Information about content of nutrients. Multiple sets of nutrient information can be specified with varying state, serving size and daily value intake base.
Association		NutrientDetail	0..*	Nutrient detail for a trade item.
Association	avpList	GS1_AttributeValu ePairList	0..1	The transmission of non-standard data done in a simple, flexible, and easy to use method.
Attribute	dailyValueIntakeRef erence	Description500	0..*	Free text field specifying the daily value intake base for on which the daily value intake per nutrient has been based. Example: "Based on a 2000 calorie diet."
Attribute	nutrientBasisQuanti ty	Measurement	0..1	The basis amount that a nutrient is measured against. In some markets, this is required by regulation. For example, 100 gr, 100 ml, etc. Please refer to the target markets implementation guideline on how to populate this attribute.
Attribute	nutrientBasisQuanti tyTypeCode	NutrientBasisQuant ityTypeCode	0..1	The type of quantity contained for example measurement, serving size, or container.
Attribute	nutrientBasisQuanti tyDescription	Description500	0..*	Additional free text information needed to correctly express nutrient basis quantity for example per bottle (100 ml).
Attribute	preparationStateCo de	PreparationTypeCo de	1..1	Code specifying the preparation state or type the nutrient information applies to, for example, unprepared, boiled, fried.
Attribute	servingSizeDescript ion	Description500	0..*	A free text field specifying the serving size for which the nutrient information has been stated for example: per 1/3 cup (42 g).

content	attribute / role	datatype /secondary class	multiplcity	definition
Attribute	servingSize	Measurement	0..*	Measurement value specifying the serving size or portion. In some markets, due to regulation, this information is used as the basis amount that a nutrient is measured against. Example: Per 30 grams. 1/2 cup, etc. Please refer to the target markets implementation guideline on how to populate this attribute.
Attribute	servingsPerPackage Description	Description500	0..*	The total number of servings based upon the serving size contained in the package for example about 24.
NutrientDetail				Information on the nutrients contained in the product. Examples are vitamins, minerals, different types of carbohydrates, different types of saturated fat, types of unsaturated fat, types of polyunsaturated fat.
Association	avpList	GS1_AttributeValuePairList	0..1	The transmission of non-standard data done in a simple, flexible, and easy to use method.
Attribute	dailyValueIntakePercent	decimal	0..1	The percentage of the recommended daily intake of a nutrient as recommended by authorities of the target market. Is expressed relative to the serving size and base daily value intake.
Attribute	dailyValueIntakePercentMeasurementPrecisionCode	MeasurementPrecisionCode	0..1	Code indicating whether the specified nutrient content for the Daily Value Intake % is exact or approximate or less than etc. One should follow local regulatory guidelines when selecting a precision.
Attribute	descriptionOnNutrientQualifier	string	0..*	The qualifier from the descriptionOnNutrient applies to a specific nutrient. Sometimes an actual nutrient quantity or % are not given, instead only a qualifier. Example descriptionOnNutrient = * Daily Value Intake does not apply. Then this would only be the * at the nutrient level. Examples include *, @, etc
Attribute	expressedAsPartOf	NutrientTypeCode	0..1	The nutrient type that is expressed as part of another nutrient total. This attribute represents the main nutrient. Example: Carnitine expressed as part of Protein. This attribute is Protein, total (PRO-) and the nutrientTypeCode is Carnitine (L_CARNITINE).
Attribute	isNutrientOnFrontOfPackage	Boolean	0..1	Indication the nutrient is listed on the front of package as a additional consumer declaration to the traditional nutritional fact panel.
Attribute	nutrientNameOnPackage	Description200	0..*	The name of the nutrient as it is listed on the fact panel on the package. Only used when the Nutrient Name on Package is different than the Nutrient Code (nutrientTypeCode). Frequently used for supplements.

content	attribute / role	datatype /secondary class	multipl city	definition
Attribute	measurementPrecisionCode	MeasurementPrecisionCode	0..1	Code indicating whether the specified nutrient content is exact or approximate. One should follow local regulatory guidelines when selecting a precision.
Attribute	nutrientTypeCode	NutrientTypeCode	1..1	Code from the list of the INFOODS food component tag names
Attribute	quantityContained	Measurement	0..*	Measurement value indicating the amount of nutrient contained in the product. Is expressed relative to the serving size.
Attribute	nutrientGroupCode	NutrientGroupCode	0..1	A code depicting a section in the nutrition or supplemented food facts table.
Attribute	nutrientSource	Description500	0..*	Information about the source ingredient from which the nutrient value is derived.
Attribute	nutrientValueDerivationCode	NutrientValueDerivationCode	0..1	The derivation of the values, percent of intake and quantity contained, provided in the nutrient class.

5.39 ONIX Publication File Information Module

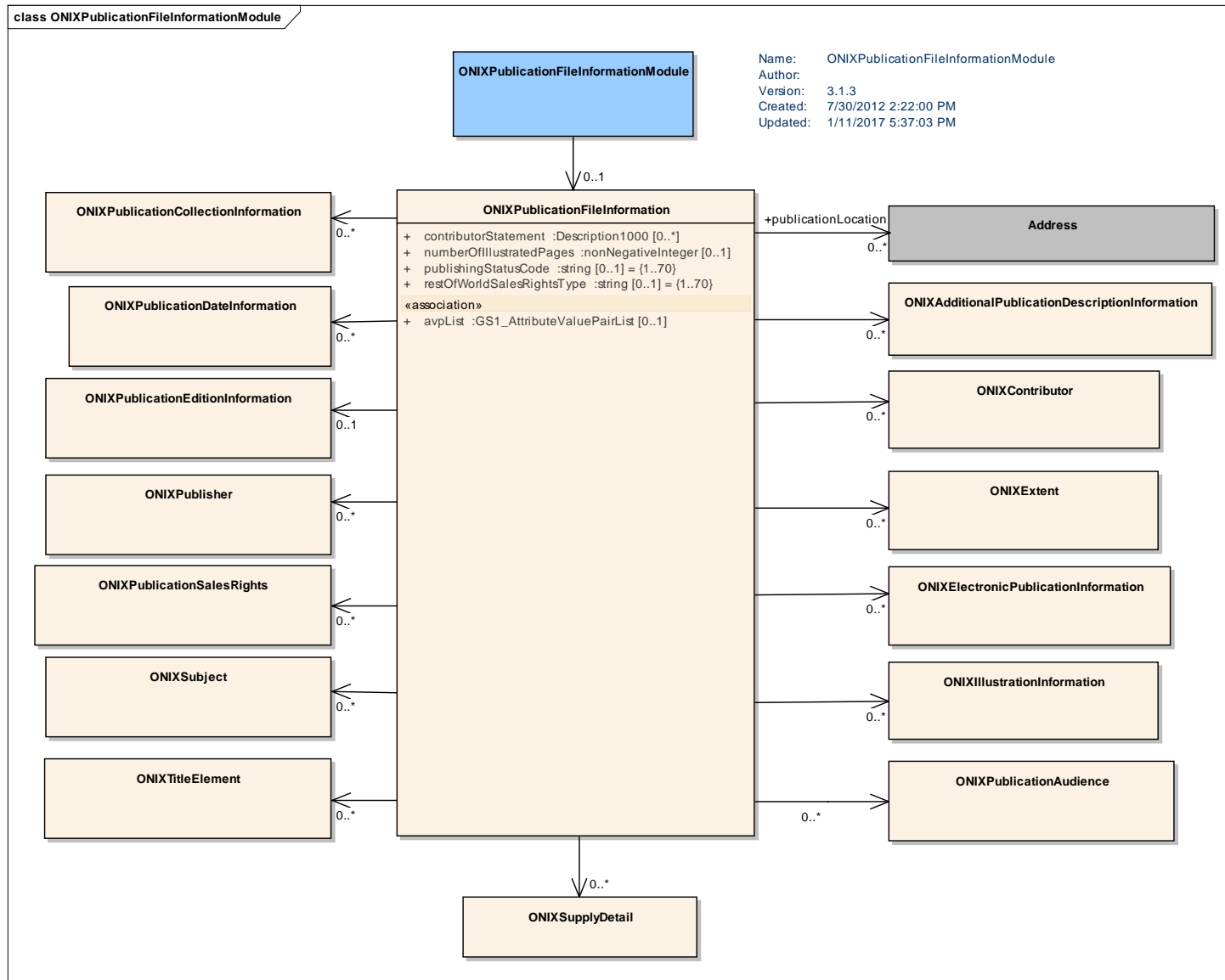

content	attribute / role	datatype /secondary class	multiplicity	definition
ONIXPublicationFileInformationModule				An extension to the trade item providing books and publication information found in ONIX files.
Association		ONIXPublicationFileInformation	0..1	Trade item information on books and publication found in ONIX files.
ONIXPublicationFileInformation				An extension to the trade item providing books and publication information found in ONIX files.
Association	publicationLocation	Address	0..*	The location (e.g. City, Country) where the item was published.
Association		ONIXAdditionalPublicationDescriptionInformation	0..*	Additional Publication Descriptions/Reviews for Publication Information
Association		ONIXContributor	0..*	information on Contributors for Publication Information
Association		ONIXExtent	0..*	Information on Extent for Publication Information
Association		ONIXElectronicPublicationInformation	0..*	Electronic publication details for a trade item.
Association		ONIXIllustrationInformation	0..*	information on Illustration Information for Publication Information
Association		ONIXPublicationAudience	0..*	Information on Target Audience for Publication Information
Association		ONIXPublisher	0..*	information on Publisher for Publication Information
Association		ONIXPublicationCollectionInformation	0..*	Information on Publication Collections for Publication Information
Association		ONIXPublicationDateInformation	0..*	Information on Publication Date Information for Publication Information
Association		ONIXPublicationEditionInformation	0..1	Information on Publication Edition Information for Publication Information
Association		OnixPublicationSalesRights	0..*	Information on Sales Rights for Publication Information
Association		ONIXSubject	0..*	This information on Subject for Publication Information

content	attribute / role	datatype /secondary class	multiplicity	definition
Association		ONIXSupplyDetail	0..*	Details for an ONIX file regarding the supply and availability of a publication.
Association		ONIXTitleElement	0..*	Information on Publication Title for Publication Information
Association	avpList	GS1_AttributeValuePairList	0..1	The transmission of non-standard data done in a simple, flexible, and easy to use method.
Attribute	contributorStatement	Description1000	0..*	Text showing how the authorship should be described in an online display, when a standard concatenation of individual contributor elements would not give a satisfactory presentation. Optional and non-repeating. When this field is sent, the receiver should use it to replace all name detail sent in the Contributor Class for display purposes only. It does not replace the biographicalNote attribute.
Attribute	numberOfIllustratedPages	nonNegativeInteger	0..1	The total number of illustrations in a book or other printed product.
Attribute	publishingStatusCode	string	0..1	Identifies the status of a published product
Attribute	restOfWorldSalesRightsType	String	0..1	A description of the sales rights applicable in territories not specifically associated with a defined sales right.

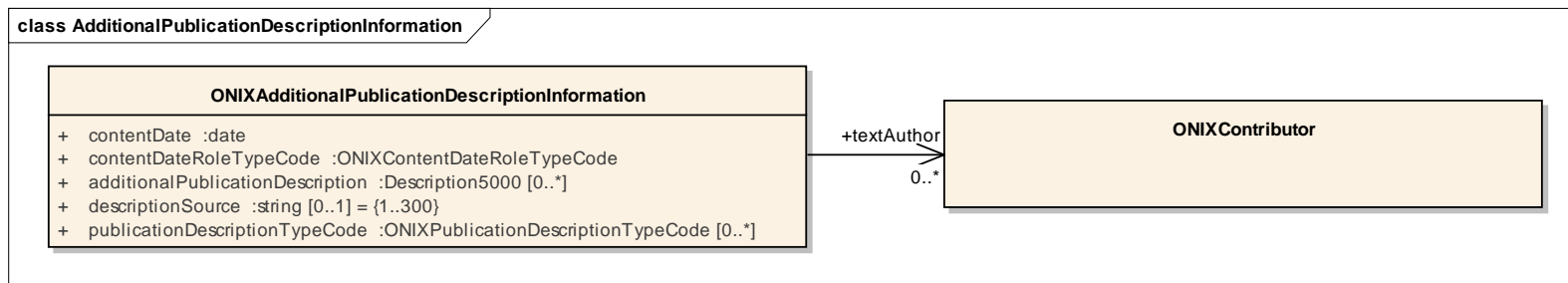

content	attribute / role	datatype /secondary class	multiplicity	definition
ONIXAdditionalPublicationDescriptionInformation				A group of data elements which together carry text related to the product.

content	attribute / role	datatype /secondary class	multiplicity	definition
Association	textAuthor	ONIXContributor	0..*	The name of an author of text
Attribute	additionalPublicationDescription	Description5000	0..*	The publication description to be used for marketing purposes (i.e. cover description, review).
Attribute	contentDate	date	1..1	Date information applicable to the Additional Description Information
Attribute	contentDateRoleTypeCode	OnixContentDateRoleTypeCode	1..1	Indicates the significance of the date in relation to the text content.
Attribute	descriptionSource	string	0..1	The name of a company or corporate body responsible for the text.
Attribute	publicationDescriptionTypeCode	ONIXPublicationDescriptionTypeCode	0..*	Identifies the type of text which is sent. This attribute uses the Description Type Code List (ONIX Code 153)

class Contributor

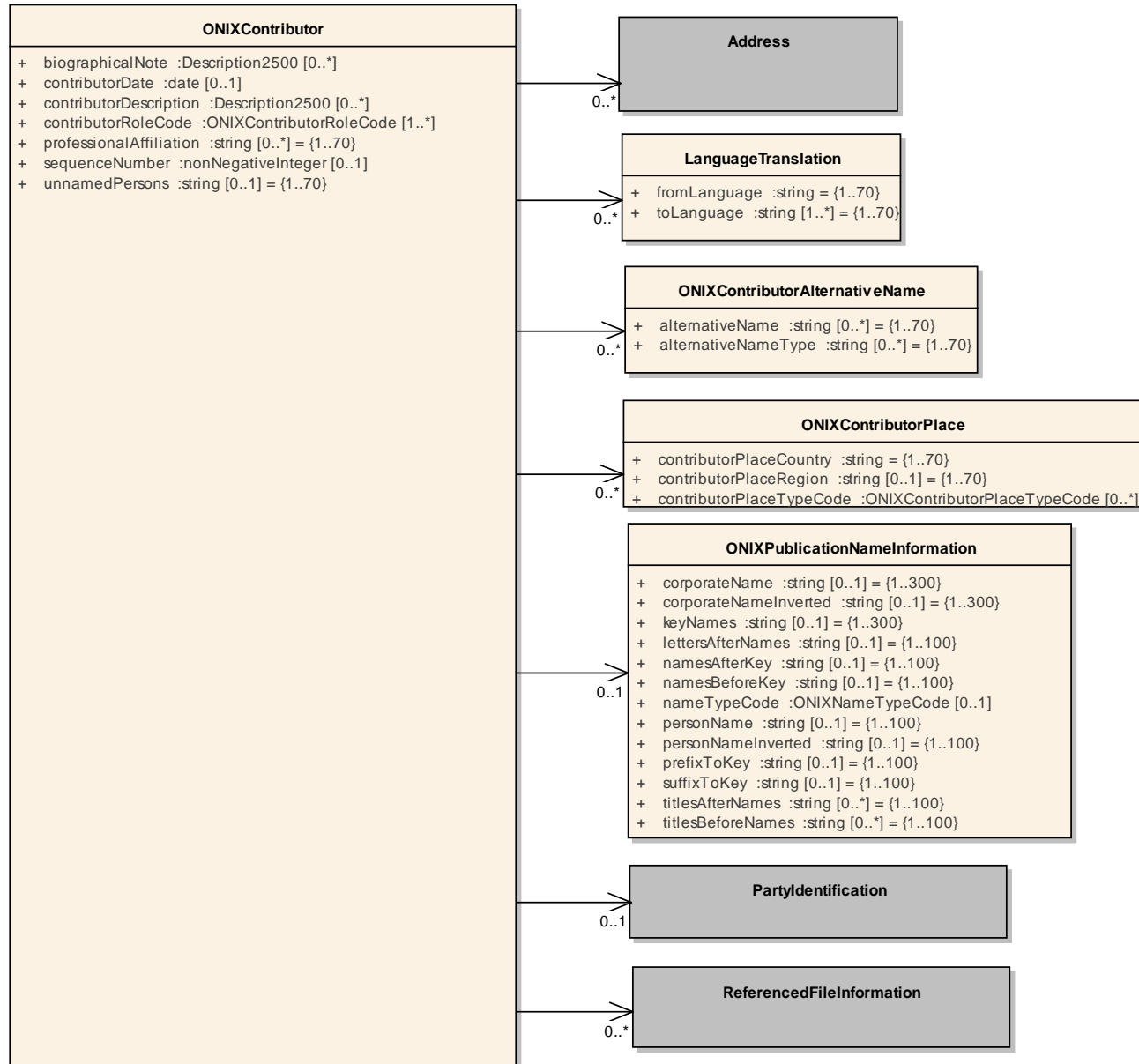

content	attribute / role	datatype /secondary class	multiplicity	definition
ONIXContributor				A group of data elements which together describe a personal or corporate contributor to a collection.
Association		Address	0..*	City and country information for a contributor.
Association		LanguageTranslation	0..*	Information on language translations performed by the contributor.
Association		ONIXContributorAlternativeName	0..*	Any alternative names for the contributor.
Association		ONIXContributorPlace	0..*	Location information for a contributor.
Association		ONIXPublicationNameInformation	0..1	Publication information for a contributor.
Association		ReferencedFileInformation	0..*	Provides the URL for the contributor website.
Association		PartyIdentification	0..1	Party identification for a contributor.
Attribute	biographicalNote	Description2500	0..*	A biographical note about a contributor to the product. May occur with a person name or with a corporate name. A biographical note should always contain the name of the person or body concerned, and it should always be presented as a piece of continuous text consisting of full sentences.
Attribute	contributorDate	date	0..1	The date specified that is associated with the person or organization identified as a contributor.
Attribute	contributorDescription	Description2500	0..*	Brief text describing a contributor to the product, at the publisher's discretion. Optional and non-repeating. It may be used with either a person or corporate name, to draw attention to any aspect of a contributor's background which supports the promotion of the book.
Attribute	contributorRoleCode	ONIXContributorRoleCode	1..*	Indicates the role played by a person or corporate body in the creation of the product. Mandatory in each occurrence of the Contributor class, and may be repeated if the same person or corporate body has more than one role in relation to the product.
Attribute	professionalAffiliation	string	0..*	An organisation to which a contributor to the product was affiliated at the time of its creation

content	attribute / role	datatype /secondary class	multiplicity	definition
Attribute	sequenceNumber	nonNegativeInteger	0..1	A number which specifies a single overall sequence of contributor names
Attribute	unnamedPersons	string	0..1	Positive indication to be given when authorship is unknown or anonymous, or when as a matter of editorial policy only a limited number of contributors are named.Utilizes Unnamed Persons Code List.
ONIXContributorPlace				Location information for a contributor.
Attribute	contributorPlaceCountry	string	1..1	A code identifying a country with which a contributor is particularly associated.
Attribute	contributorPlaceRegion	string	0..1	Identifies a region with which a contributor is particularly associated
Attribute	contributorPlaceTypeCode	ONIXContributorPlaceTypeCode	0..*	Identifies a region with which a contributor is particularly associated
ONIXPublicationNameInformation				Publication information for a contributor.
Attribute	corporateName	string	0..1	The name of a corporate body.
Attribute	corporateNameInverted	string	0..1	The inverted name of a corporate body
Attribute	keyNames	string	0..1	Part of a structured name of a person who contributed to the creation of the product: key name(s), i.e. the name elements normally used to open an entry in an alphabetical list, e.g. 'Smith' or 'Garcia Marquez' or 'Madonna' or 'Francis de Sales' (in Saint Francis de Sales).
Attribute	lettersAfterNames	string	0..1	Qualifications and honours following a person's names, e.g. 'CBE FRS'.
Attribute	namesAfterKey	string	0..1	Part of a structured name of a person who contributed to the creation of the product: name suffix, or name(s) following a person's key name(s), e.g. 'Ibrahim' (in Anwar Ibrahim).
Attribute	namesBeforeKey	string	0..1	Part of a structured name of a person who contributed to the creation of the product: name(s) and/or initial(s) preceding a person's key name(s), e.g. James J
Attribute	nameTypeCode	ONIXNameTypeCode	0..1	Indicates the type of the name

content	attribute / role	datatype /secondary class	multiplicity	definition
Attribute	personName	string	0..1	The name of a person who contributed to the creation of the product, unstructured, and presented in normal order.
Attribute	personNameInverted	string	0..1	The name of a person who contributed to the creation of the product, presented in inverted order, with the element used for alphabetical sorting placed first.
Attribute	prefixToKey	string	0..1	Part of a structured name of a person who contributed to the creation of the product: a prefix which precedes the key name(s) but which is not to be treated as part of the key name, e.g. 'van' in Ludwig van Beethoven. This element may also be used for titles that appear after given names and before key names, e.g. 'Lord' in Alfred, Lord Tennyson.
Attribute	suffixToKey	string	0..1	Part of a structured name of a person who contributed to the creation of the product: a suffix following a person's key name(s), e.g. 'Jr' or 'III'.
Attribute	titlesAfterNames	string	0..*	Part of a structured name of a person who contributed to the creation of the product: titles following a person's names, e.g. 'Duke of Edinburgh'.
Attribute	titlesBeforeNames	string	0..*	Part of a structured name of a person who contributed to the creation of the product: qualifications and/or titles preceding a person's names, e.g. 'Professor' or 'HRH Prince' or 'Saint'.
LanguageTranslation				Information on any language translations (from and to) that apply to the published trade item.
Attribute	fromLanguage	string	1..1	Used only when the code value is B06, B08 or B10 indicating a translator, to specify the source language from which the translation was made. This element makes it possible to specify a translator's exact responsibility when a work involves translation from two or more languages. Optional and repeatable in the event that a single person has been responsible for translation from two or more languages.

content	attribute / role	datatype /secondary class	multiplicity	definition
Attribute	toLanguage	string	1..*	Used only when the code value is B06, B08 or B10 indicating a translator, to specify the target language into which the translation was made. This element makes it possible to specify a translator's exact responsibility when a work involves translation into two or more languages. Optional and repeatable in the event that a single person has been responsible for translation to two or more languages.
ONIXContributorAlternativeName				Any alternative names for the contributor.
Attribute	alternativeName	string	0..*	It may be used to send a pseudonym as well as a real name, where both names are on the product, eg to handle such cases as 'Ian Rankin writing as Jack Harvey'; or to send an authority-controlled form of a name; or to identify the real name of the contributor where the book is written under a pseudonym (and the real identity need not be kept private). Note that in all cases, the primary name is that used on the product, and the alternative name merely provides additional information.
Attribute	alternativeNameType	string	0..*	Indicates the type of the name sent in an occurrence of the composite.

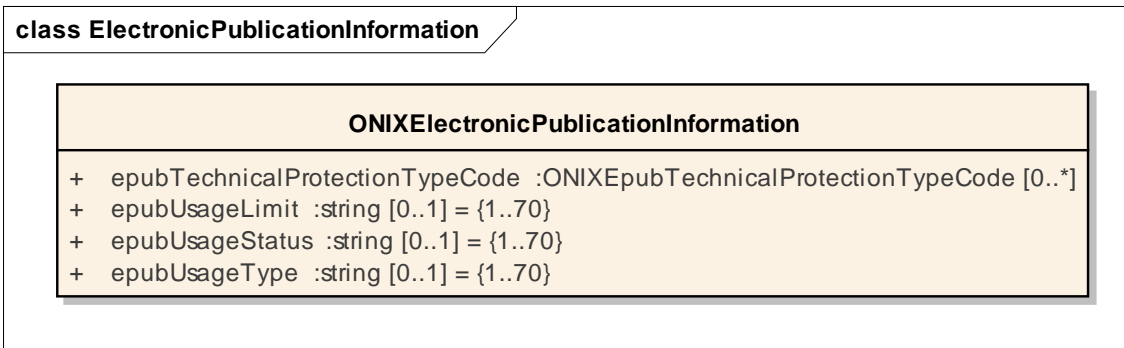

content	attribute / role	datatype /secondary class	multiplicity	definition
ONIXElectronicPublicationInformation				Describes a usage constraint on a digital product, whether imposed by DRM technical protection or inherent in the platform used (or the absence of such constraint).
Attribute	epubTechnicalProtectionTypeCode	ONIXEpubTechnicalProtectionTypeCode	0..*	Specifies whether a digital product has DRM or other technical protection features.
Attribute	epubUsageLimit	string	0..1	Specifies a quantitative limit on a particular type of usage of a digital product.
Attribute	epubUsageStatus	string	0..1	Specifies the status of a usage of a digital product, e.g. permitted without limit, permitted with limit, prohibited. Use ONIXUsageStatusCode.
Attribute	epubUsageType	string	0..1	Specifies a usage of a digital product. Use ONIXUsageTypeCode

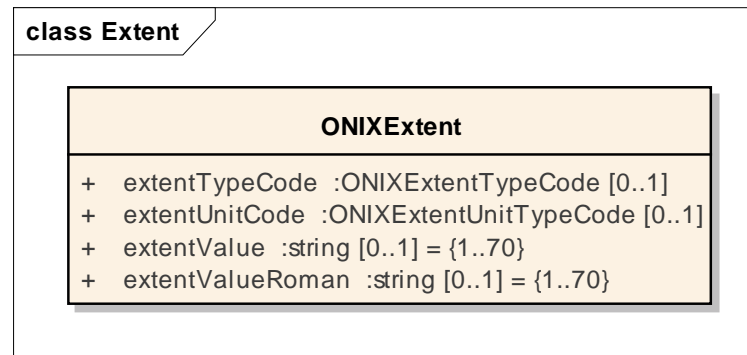

content	attribute / role	datatype /secondary class	multiplicity	definition
ONIXExtent				A repeatable group of data elements which together describe an extent pertaining to the product. Optional, but in practice required for most products, e.g. to give the number of pages in a printed book or paginated ebook, or to give the running time of an audiobook.

content	attribute / role	datatype /secondary class	multiplicity	definition
Attribute	extentTypeCode	ONIXExtentTypeCode	0..1	An ONIX code which identifies the type of extent carried in the composite, eg running time for an audio or video product. Mandatory in each occurrence of the <Extent> composite, and non-repeating. From Issue 9 of the code lists, an extended set of values for <ExtentType> has been defined to allow more accurate description of pagination.
Attribute	extentUnitCode	ONIXExtentUnitTypeCode	0..1	An ONIX code indicating the unit used for the <ExtentValue> and the format in which the value is presented. Mandatory in each occurrence of the <Extent> composite, and non-repeating. Recommended to use ONIX List 24: Extent Unit Code.
Attribute	extentValue	string	0..1	The numeric value of the extent specified in <ExtentType>. Optional, and non-repeating. However, either <ExtentValue> or <ExtentValueRoman> must be present in each occurrence of the <Extent> composite; and it is very strongly recommended that <ExtentValue> should always be included, even when the original product uses Roman numerals.
Attribute	extentValueRoman	string	0..1	The value of the extent expressed in Roman numerals. Optional, and non-repeating. Used only for page runs which are numbered in Roman.

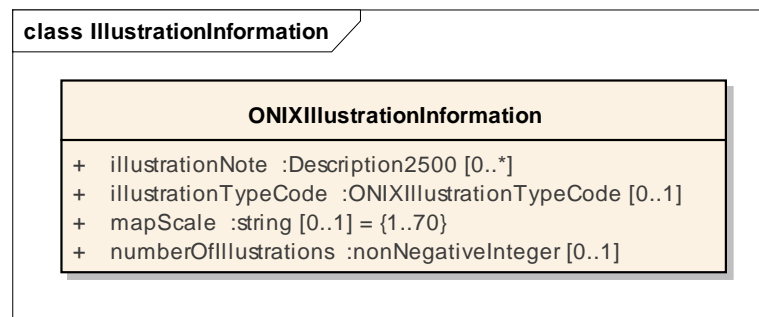

content	attribute / role	datatype /secondary class	multiplicity	definition
ONIXIllustrationInformation				A repeatable group of data elements which together specify the number of illustrations which the product carries.
Attribute	illustrationNote	Description2500	0..*	For books or other text media only, this data element carries text stating the number and type of illustrations. The text may also include other content items, eg maps, bibliography, tables, index etc. Optional and non-repeating.
Attribute	illustrationTypeCode	ONIXIllustrationTypeCode	0..1	Identifies the type of illustration or other content to which an occurrence of the composite refers. Mandatory in each occurrence
Attribute	mapScale	string	0..1	The scale of a map, expressed as a ratio 1:nnnnn; only the number nnnnn is carried in the data element, without spaces or punctuation. Optional, and repeatable if a product comprises maps with two or more different scales.
Attribute	numberOfIllustrations	nonNegativeInteger	0..1	The number of illustrations or other content items of the type specified. Optional and non-repeating.

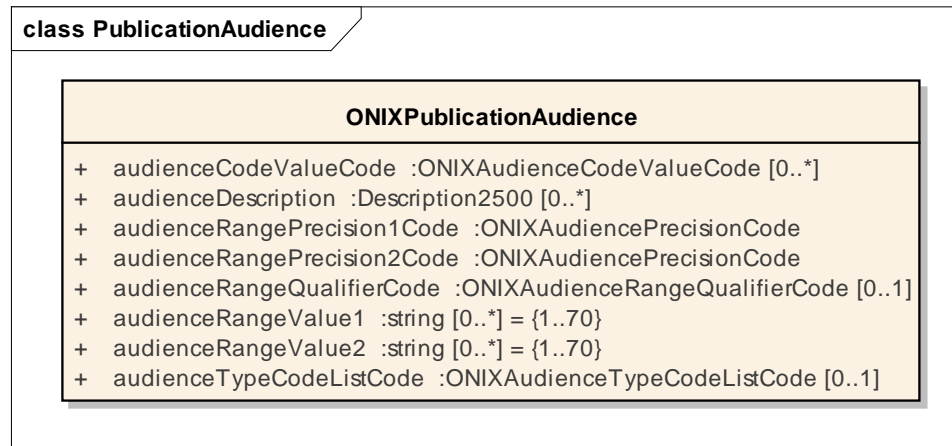

content	attribute / role	datatype /secondary class	multiplicity	definition
ONIXPublicationAudience				A repeatable group of data elements which together describe an audience to which the product is directed.
Attribute	audienceCodeValueCode	ONIXAudienceCodeValueCode	0..*	Identifies the applicable values of the appropriate audienceCodeType. For Audience Code Type 01 (Onix Type) this value should be populated with Onix Audience Code 28 (Books: Onix Audience Code Value Code)
Attribute	audienceDescription	Description2500	0..*	Free text describing the audience for which a product is intended. Optional and non-repeating.
Attribute	audienceRangePrecision1Code	ONIXAudiencePrecisionCode	1..1	Specifies the 'precision' of the value in the AudienceRange attribute which follows (From, To, Exact). Mandatory in each occurrence of the AudienceRange, and non-repeating.
Attribute	audienceRangePrecision2Code	ONIXAudiencePrecisionCode	1..1	Specifies the 'precision' of the value in AudienceRange attribute which follows. Optional and non-repeating. This second occurrence of the two elements audienceRangePrecision and audienceRange is required only when a 'From ... to ...' range is specified.
Attribute	audienceRangeQualifierCode	ONIXAudienceRangeQualifierCode	0..1	Specifies the attribute (age, school grade etc) which is measured by the value in the AudienceRange attribute.
Attribute	audienceRangeValue1	string	0..*	A value indicating an exact position within a range, or the upper or lower end of a range.
Attribute	audienceRangeValue2	string	0..*	A value indicating the upper end of a range.
Attribute	audienceTypeCodeListCode	ONIXAudienceTypeCodeListCode	0..1	Identifies the broad audience or readership for which a product is intended. Repeatable if the product is intended for two or more groups.

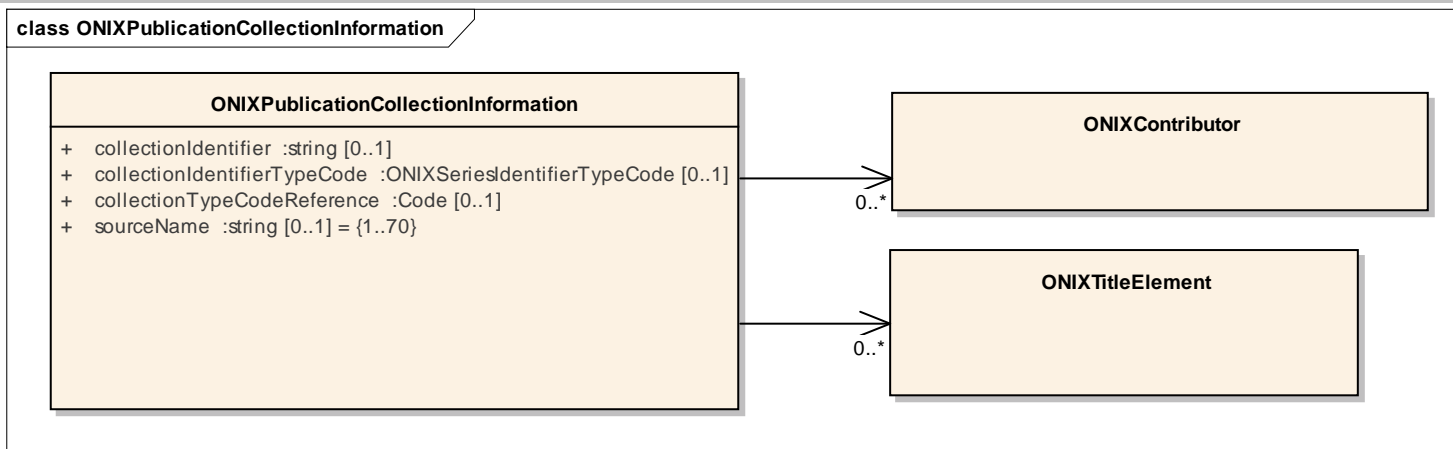

content	attribute / role	datatype /secondary class	multiplicity	definition
ONIXPublicationCollectionInformation				Carries attributes of a bibliographic collection of which the product is part.
Association		ONIXContributor	0..*	A contributor for a publication collection.
Association		ONIXTitleElement	0..*	The title element for a publication collection.
Attribute	collectionIdentifier	string	0..1	Identifier of the type specified in the collectionIDType field.
Attribute	collectionIdentifierTypeCode	ONIXSeriesIdentifierTypeCode	0..1	Identifies the scheme from which an identifier in the collectionIdentifier is taken. This attribute utilizes the Series Identifier Type Code List (Onix List 13)
Attribute	collectionTypeCodeReference	Code	0..1	Indicates the type of a bibliographic collection: publisher collection, ascribed collection, or unspecified
Attribute	sourceName	string	0..1	If the CollectionType code indicates an 'ascribed collection' (i.e. a collection which has been identified and described by a supply chain organisation other than the publisher), this element may be used to carry the name of the organisation responsible.

class ONIXPublicationDateInformation

ONIXPublicationDateInformation

- + publicationDate :date
- + publicationDateTypeCode :ONIXPublicationDateTypeCode

content	attribute / role	datatype /secondary class	multiplicity	definition
ONIXPublicationDateInformation				An optional and repeatable group of data elements which together specify a date associated with the text carried in an occurrence of the composite, e.g. date when quoted text was published.
	publicationDate	Date	1..1	The date specified in the field. Mandatory in each occurrence of the composite, and non-repeating. May carry a dateformat attribute: if the attribute is missing, then indicates the format of the date; if both dateformat attribute and element are missing, the default format is YYYYMMDD.
	publicationDateTypeCode	ONIXPublicationDateTypeCode	1..1	An ONIX code indicating the significance of the date in relation to the text content. Mandatory in each occurrence of the composite, and non-repeating. In ONIX this utilizes list 155.

class PublicationEditionInformation

ONIXPublicationEditionInformation

- + editionNumber :string [0..1] = {1..70}
- + editionStatement :Description2500 [0..*]
- + editionTypeCode :ONIXEditionTypeCode [0..*]
- + editionVersionNumber :string [0..1] = {1..70}

content	attribute / role	datatype /secondary class	multiplicity	definition
ONIXPublicationEditionInformation				Describes an edition of a work which is manifested in the product. Its use should generally be limited to describing an edition whose content is materially different from that of other editions of the same work. However, it may sometimes be used to specify a product feature (eg 'bilingual edition') without necessarily implying that another, different, edition also exists.
Attribute	editionNumber	string	0..1	The number of a numbered edition. Optional and non-repeating. Normally sent only for the second and subsequent editions of a work, but by agreement between parties to an ONIX exchange a first edition may be explicitly numbered.
Attribute	editionStatement	Description2500	0..*	A short free-text description of a version or edition. Optional and non-repeating. When used, an <EditionStatement> must be complete in itself, ie it should not be treated as merely supplementary to an <EditionType> or an <EditionNumber>. An <EditionStatement> should be strictly limited to describing features of the content of the edition, and should not include aspects such as rights or market restrictions.
Attribute	editionTypeCode	ONIXEditionTypeCode	0..*	Indicates the type of a version or edition. Optional, and repeatable if the product has characteristics of two or more types (eg 'revised' and 'annotated').

content	attribute / role	datatype /secondary class	multiplicity	definition
Attribute	editionVersionNumber	string	0..1	The number of a numbered revision within an edition number. To be used only where a publisher uses such two-level numbering to indicate revisions which do not constitute a new edition under a new ISBN or other distinctive product identifier. Optional and non-repeating. If this field is used, an <EditionNumber> must also be present.

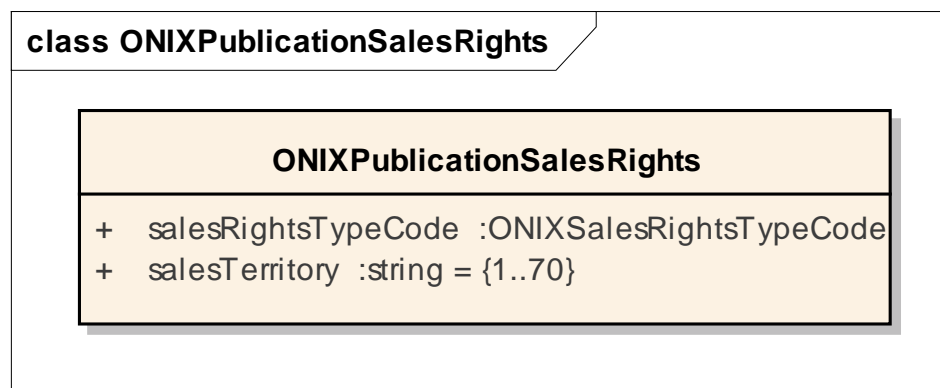

content	attribute / role	datatype /secondary class	multiplicity	definition
ONIXPublicationSalesRights				Identifies territorial sales rights a brand owner chooses to exercise in a product. When specifying a territory in which the product is not for sale, the publisher and product ID for an edition which is available in the specified territory can optionally be included.
Attribute	salesRightsTypeCode	ONIXSalesRightsTypeCode	1..1	Identifies the type of sales right or exclusion which applies in the territories which are associated with it. Mandatory in each occurrence of the <SalesRights> composite, and non-repeating. Values include: for sale with exclusive rights, for sale with non-exclusive rights, not for sale.

content	attribute / role	datatype /secondary class	multiplicity	definition
Attribute	salesTerritory	string	1..1	Identify a territory in which the rights specified in <SalesRightsType> are applicable. Mandatory in each occurrence of the <SalesRights> composite, and non-repeating.

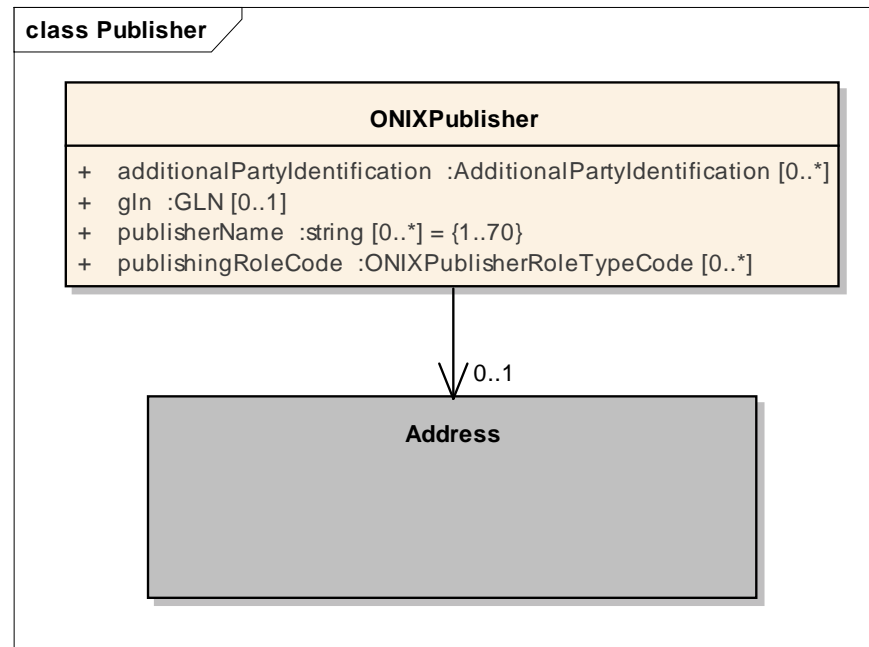

content	attribute / role	datatype /secondary class	multiplicity	definition
ONIXPublisher				A repeatable group of data elements which together identify an entity which is associated with the publishing of a product. The composite allows additional publishing roles to be introduced without adding new fields.
Association		Address	0..1	City and country information for a publisher.
Attribute	additionalPartyIdentification	AdditionalPartyIdentification	0..*	Identification of a party by use of a code other than the Global Location Number.

content	attribute / role	datatype /secondary class	multiplicity	definition
Attribute	gln	GLN	0..1	The Global Location Number (GLN) is a structured Identification of a physical location, legal or functional entity within an enterprise. The GLN is the primary party identifier. Each party identified in the trading relationship must have a primary party Identification.
Attribute	publisherName	string	0..*	A name which identifies a proprietary identifier scheme (ie a scheme which is not a standard and for which there is no individual ID type code) when, and only when, the code in the <PublisherIDType> element indicates a proprietary scheme.
Attribute	publishingRoleCode	ONIXPublisherRole TypeCode	0..*	Identifies a role played by an entity in the publishing of a product.

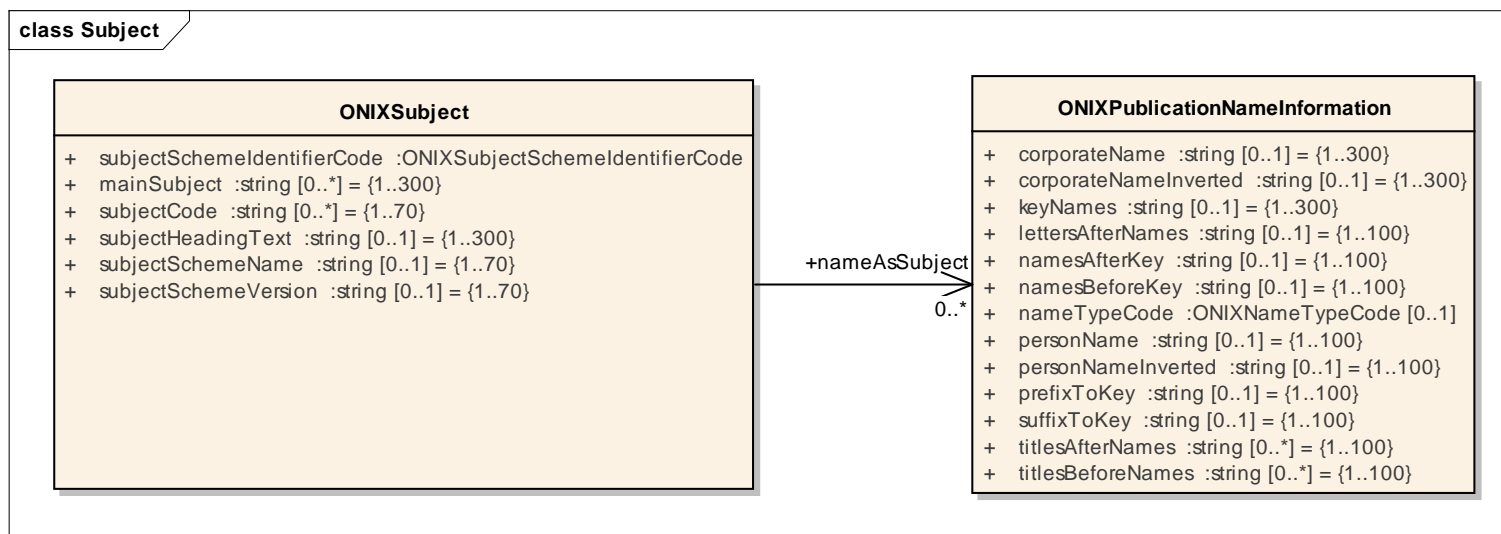

content	attribute / role	datatype /secondary class	multiplicity	definition
ONIXPublicationNameInformation				Publication information for a contributor.
Attribute	corporateName	string	0..1	The name of a corporate body.

content	attribute / role	datatype /secondary class	multiplicity	definition
Attribute	corporateNameInverted	string	0..1	The inverted name of a corporate body
Attribute	keyNames	string	0..1	Part of a structured name of a person who contributed to the creation of the product: key name(s), i.e. the name elements normally used to open an entry in an alphabetical list, e.g. 'Smith' or 'Garcia Marquez' or 'Madonna' or 'Francis de Sales' (in Saint Francis de Sales).
Attribute	lettersAfterNames	string	0..1	Qualifications and honours following a person's names, e.g. 'CBE FRS'.
Attribute	namesAfterKey	string	0..1	Part of a structured name of a person who contributed to the creation of the product: name suffix, or name(s) following a person's key name(s), e.g. 'Ibrahim' (in Anwar Ibrahim).
Attribute	namesBeforeKey	string	0..1	Part of a structured name of a person who contributed to the creation of the product: name(s) and/or initial(s) preceding a person's key name(s), e.g. James J
Attribute	nameTypeCode	ONIXNameTypeCode	0..1	Indicates the type of the name
Attribute	personName	string	0..1	The name of a person who contributed to the creation of the product, unstructured, and presented in normal order.
Attribute	personNameInverted	string	0..1	The name of a person who contributed to the creation of the product, presented in inverted order, with the element used for alphabetical sorting placed first.
Attribute	prefixToKey	string	0..1	Part of a structured name of a person who contributed to the creation of the product: a prefix which precedes the key name(s) but which is not to be treated as part of the key name, e.g. 'van' in Ludwig van Beethoven. This element may also be used for titles that appear after given names and before key names, e.g. 'Lord' in Alfred, Lord Tennyson.
Attribute	suffixToKey	string	0..1	Part of a structured name of a person who contributed to the creation of the product: a suffix following a person's key name(s), e.g. 'Jr' or 'III'.
Attribute	titlesAfterNames	string	0..*	Part of a structured name of a person who contributed to the creation of the product: titles following a person's names, e.g. 'Duke of Edinburgh'.

content	attribute / role	datatype /secondary class	multiplicity	definition
Attribute	titlesBeforeNames	string	0..*	Part of a structured name of a person who contributed to the creation of the product: qualifications and/or titles preceding a person's names, e.g. 'Professor' or 'HRH Prince' or 'Saint'.
ONIXSubject				Specifies a subject classification or subject heading.
Association	nameAsSubject	ONIXPublicationNameInformation	0..*	Name as a subject
Attribute	subjectSchemeIdentifierCode	ONIXSubjectSchemeIdentifierCode	1..1	For category schemes that use code values, use the associated element to carry the value (if so required, the element can be used simultaneously to carry the text equivalent of the code). For schemes that use text headings, use the element to carry the text of the category heading.
Attribute	mainSubject	string	0..*	Main subject category for the product
Attribute	subjectCode	string	0..*	A subject class or category code from the scheme specified in the element. Either or both must be present in each occurrence of the composite.
Attribute	subjectHeadingText	string	0..1	The text of a subject heading taken from the scheme specified in the element, or of free language keywords if the scheme is specified as 'keywords'; or the text equivalent to the value, if both code and text are sent. Either or both must be present in each occurrence of the composite.
Attribute	subjectSchemeName	string	0..1	A name identifying a proprietary subject scheme (i.e. a scheme which is not a standard and for which there is no individual identifier code) when is coded '24'.
Attribute	subjectSchemeVersion	string	0..1	A number which identifies a version or edition of the subject scheme specified in the associated element.

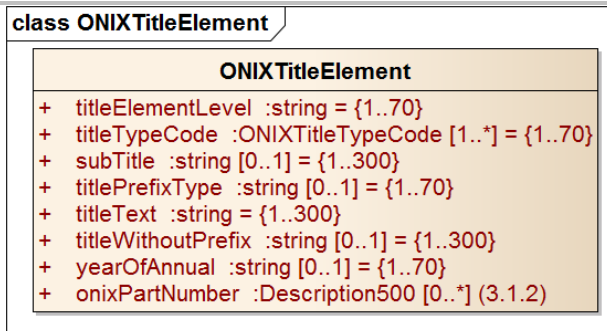

content	attribute / role	datatype /secondary class	multiplicity	definition
Attribute	titleElementLevel	string	1..1	Code indicating the level of a title element: collection level, subcollection level, or product level. Mandatory in each occurrence of the TitleElement composite.
Attribute	titleTypeCode	ONIXTitleTypeCode	1..*	Indicates the type of a title.
Attribute	subTitle	string	0..1	The text of a subtitle, if any. 'Subtitle' means any added words which appear with the title element given in an occurrence of the <TitleElement> composite, and which amplify and explain the title element, but which are not considered to be part of the title element itself.
Attribute	titlePrefixType	string	0..1	Text at the beginning of a title element which is to be ignored for alphabetical sorting. Optional and non-repeating; can only be used if the <TitleWithoutPrefix> element is also present. These two elements may be used in combination in applications where it is necessary to distinguish an initial word or character string which is to be ignored for filing purposes, eg in library systems and in some bookshop databases.
Attribute	titleText	string	1..1	The text of a title element, excluding any subtitle. Optional and non-repeating.
Attribute	titleWithoutPrefix	string	0..1	The text of a title element without the title prefix; and excluding any subtitle. Optional and non-repeating; can only be used if the TitlePrefix element is also present.
Attribute	yearOfAnnual	string	0..1	When the year of an annual is part of a title, this field should be used to carry the year (or, if required, a spread of years such as 2009-2010). Optional and non-repeating.



content	attribute / role	datatype /secondary class	multiplicity	definition
Attribute	onixPartNumber	Description500	0..*	When a title element includes a part designation within a larger whole (e.g. <i>Part I</i> , or Volume 3), this field should be used to carry the number and its 'caption' as text.

5.40 Optics Device Information Module

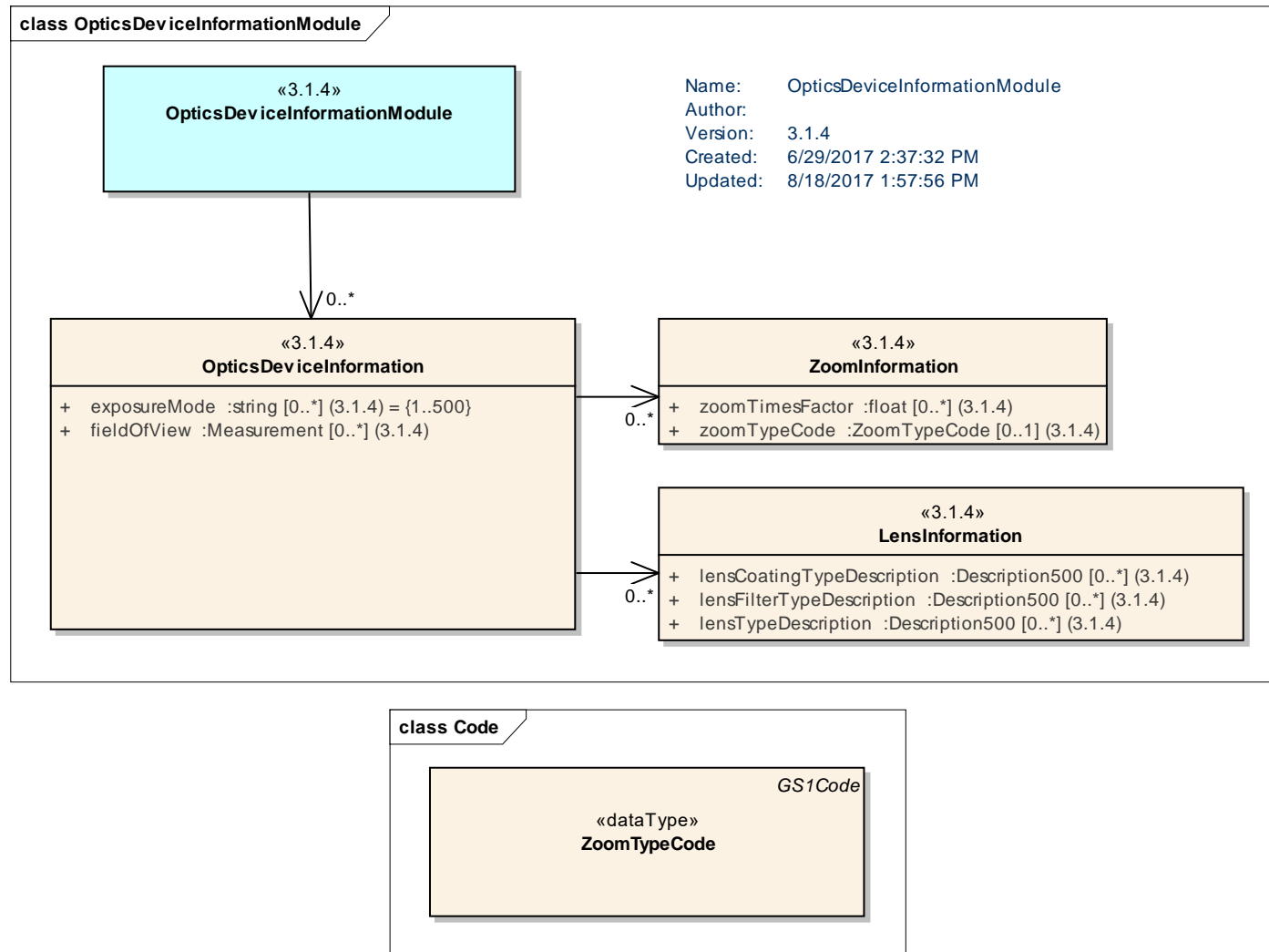

content	attribute / role	datatype /secondary class	multiplicity	definition
LensInformation				Information on a lens for an optical device.
Attribute	lensCoatingTypeDescription	Description500	0..*	A description of the type of coating either protective or other feature the coating brings to the lens. Examples anti-reflective, mirrored, tinted, scratch resistant, multicoated.
Attribute	lensFilterTypeDescription	Description500	0..*	The type of lens filter that trade item is or comes with. Examples: protective, skylight, colour tint, etc
Attribute	lensTypeDescription	Description500	0..*	Description of an optical lens or assembly of lenses used in conjunction with a camera body and mechanism to make images of objects either on photographic film or on other media capable of storing an image chemically or electronically. Examples include ultra wide angle, wide angle, standard, telephoto.
OpticsDeviceInformationModule				A module including information on optics devices for example lens for cameras, microscopes, telescopes.
Association		OpticsDeviceInformation	0..*	Details on optics devices for example lens for cameras, microscopes, telescopes.
OpticsDeviceInformation				Information on optics devices for example lens for cameras, microscopes, telescopes.
Association		LensInformation	0..*	Information on a lens for an optical device.
Association		ZoomInformation	0..*	Zoom information for a photography/optics Device.
Attribute	exposureMode	string	0..*	Description of each of the various automatic or manual exposure (shooting) modes a camera comes with for example, P (programmed auto), S (shutter-priority auto), A (aperture-priority auto), M (manual).
Attribute	fieldOfView	Measurement	0..*	Real field of view (field of vision) is the angle of the visible field, seen without moving the item, measured from the central point of the objective lens. In games the extent of the observable world that is seen at any given moment. This is used by such items as: microscope, rifle scope, cameras, binoculars are just some type of items. Measure in linear length or angular degrees for example 300 metres (MTR), 45 degrees (DD).
ZoomInformation				Information on the abilities of a product to go from long view to a close-up or vice versa.
Attribute	zoomTimesFactor	float	0..*	The distance (how far or close), the zoom is capable of for example 2, 10.5, 100.
Attribute	zoomTypeCode	ZoomTypeCode	0..1	A code depicting the type of zoom the device or lens has for example DIGITAL or OPTICAL.

5.41 Organism Classification Module

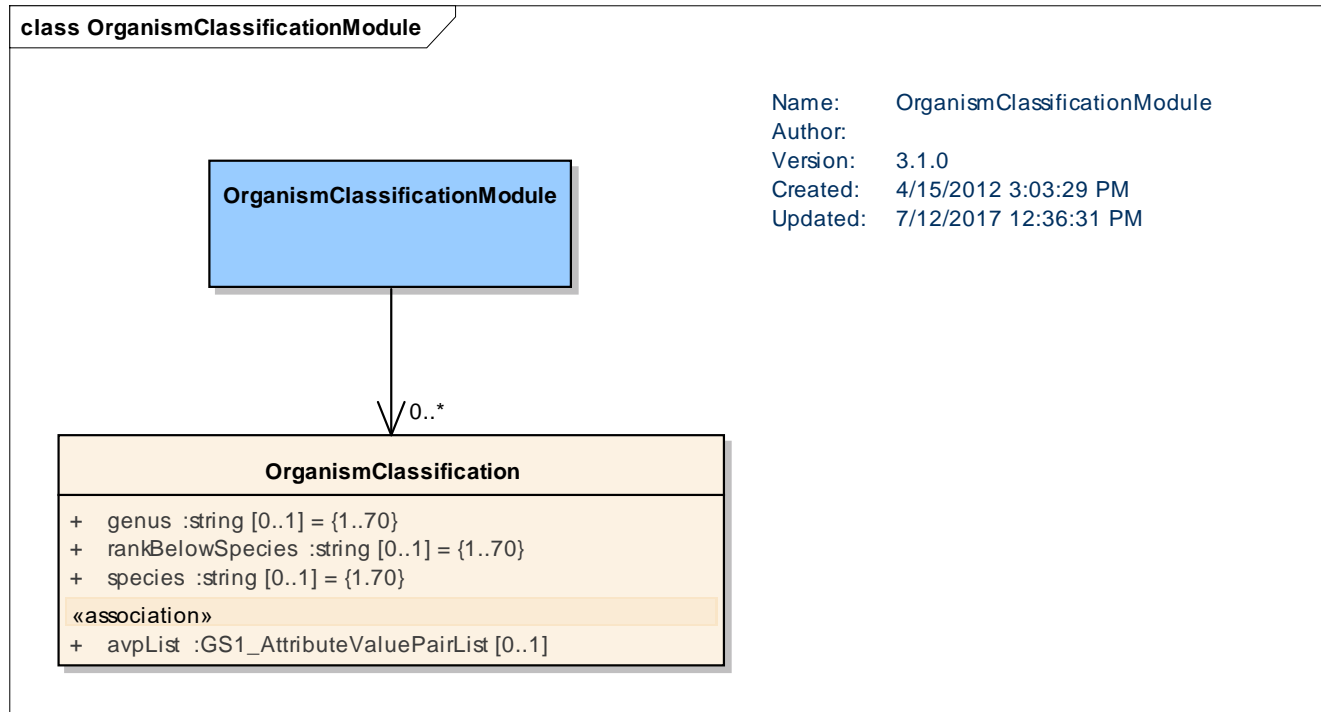

content	attribute / role	datatype /secondary class	multiplcity	definition
OrganismClassification				Hierarchical system for grouping and naming types of living organisms.
Association	avpList	GS1_AttributeValuePairList	0..1	The transmission of non-standard data done in a simple, flexible, and easy to use method.
Attribute	genus	string	0..1	A taxonomic category ranking below a family and above a species and generally consisting of a group of species exhibiting similar characteristics. In taxonomic nomenclature the genus name is used, either alone or followed by a Latin adjective or epithet, to form the name of a species.

content	attribute / role	datatype /secondary class	multipl city	definition
Attribute	rankBelowSpecies	string	0..1	<p>Either the Sub-Species, Variety, Sub-Variety, Form, and/or Sub-Form of an organism. All are taxonomic rank below that of species.</p> <ul style="list-style-type: none"> • A Sub-Species is a taxonomic rank subordinate to species. • A Variety will have an appearance distinct from other varieties, but will hybridize freely with other varieties of the same species (if brought into contact). Usually varieties will be geographically separate from each other. • A Sub-Variety is a subordinate variety, or a division of a variety. <p>A Form usually designates a group with a noticeable but minor deviation. For instance, white-flowered forms of species that usually have coloured flowers can be named a "f. alba".</p> <p>It is recommended to place an Abbreviation at the beginning of the text to clarify to what type the text belongs. The recommended abbreviations are:</p> <ul style="list-style-type: none"> • subspecies (Abbreviation not required for Animals) - - subsp or ssp • varietas (variety) -- var • subvarietas (sub-variety) -- subvar • forma (form) -- form or f • subforma (sub-forma) -- subf
Attribute	species	string	0..1	<p>A fundamental category of taxonomic classification, ranking below a genus and consisting of related organisms capable of interbreeding. An organism belonging to such a category, represented in binomial nomenclature by a lower case Latin adjective or noun following a capitalized genus name, as in <i>Ananas comosus</i>, the pineapple, and <i>Equus caballus</i>, the horse.</p>
OrganismClassificationModule				<p>Hierarchical system for grouping and naming types of living organisms.</p>
Association		OrganismClassification	0..*	<p>Hierarchical system for grouping and naming types of living organisms.</p>

5.42 Packaging Information Module

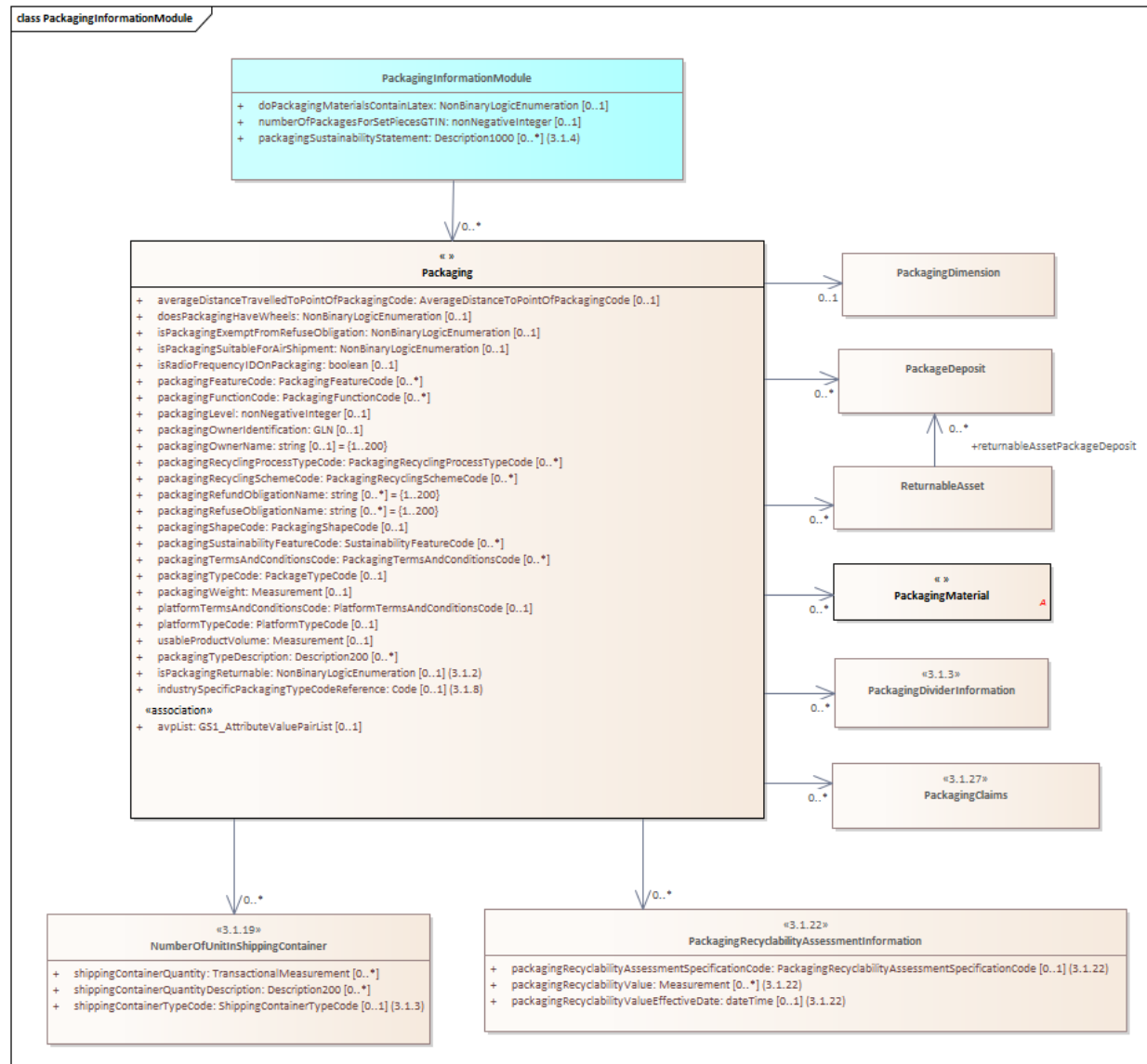

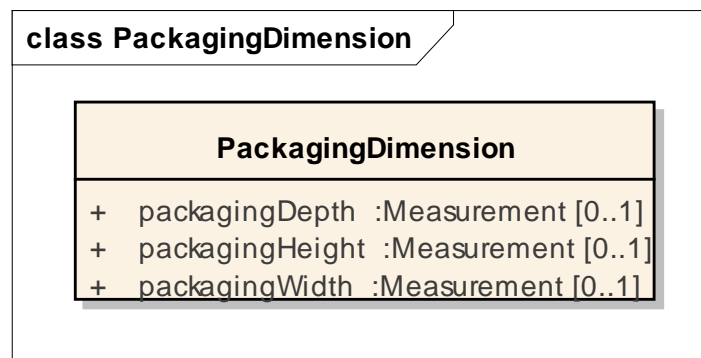
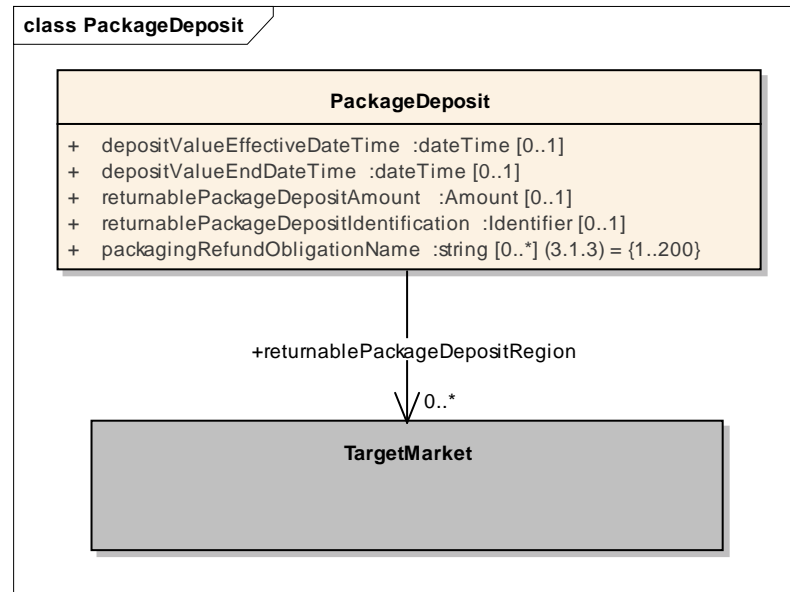

class PackagingDiv iderInformation

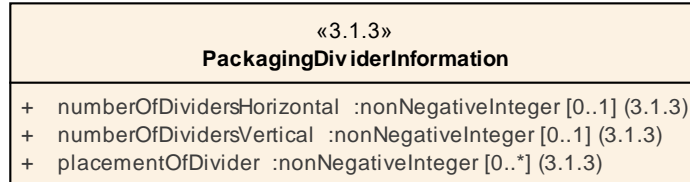

class ReturnableAsset

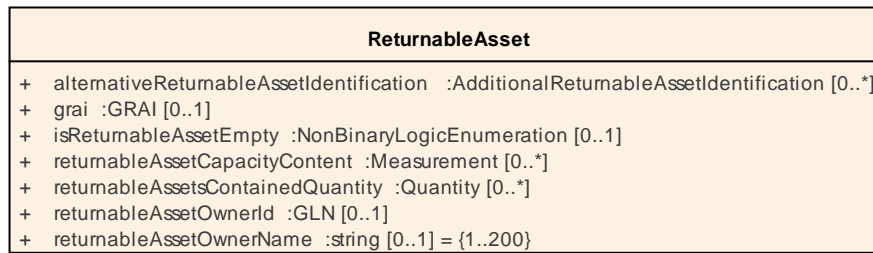

+returnableAssetPackageDeposit /0..*

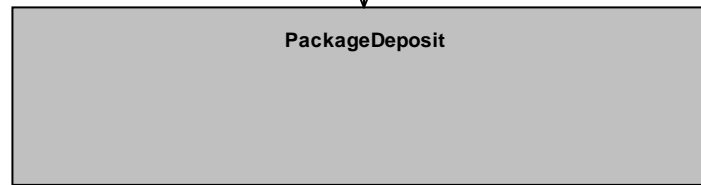

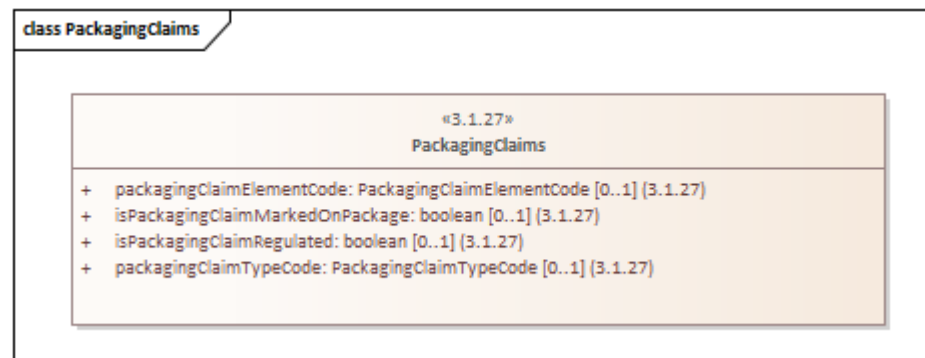
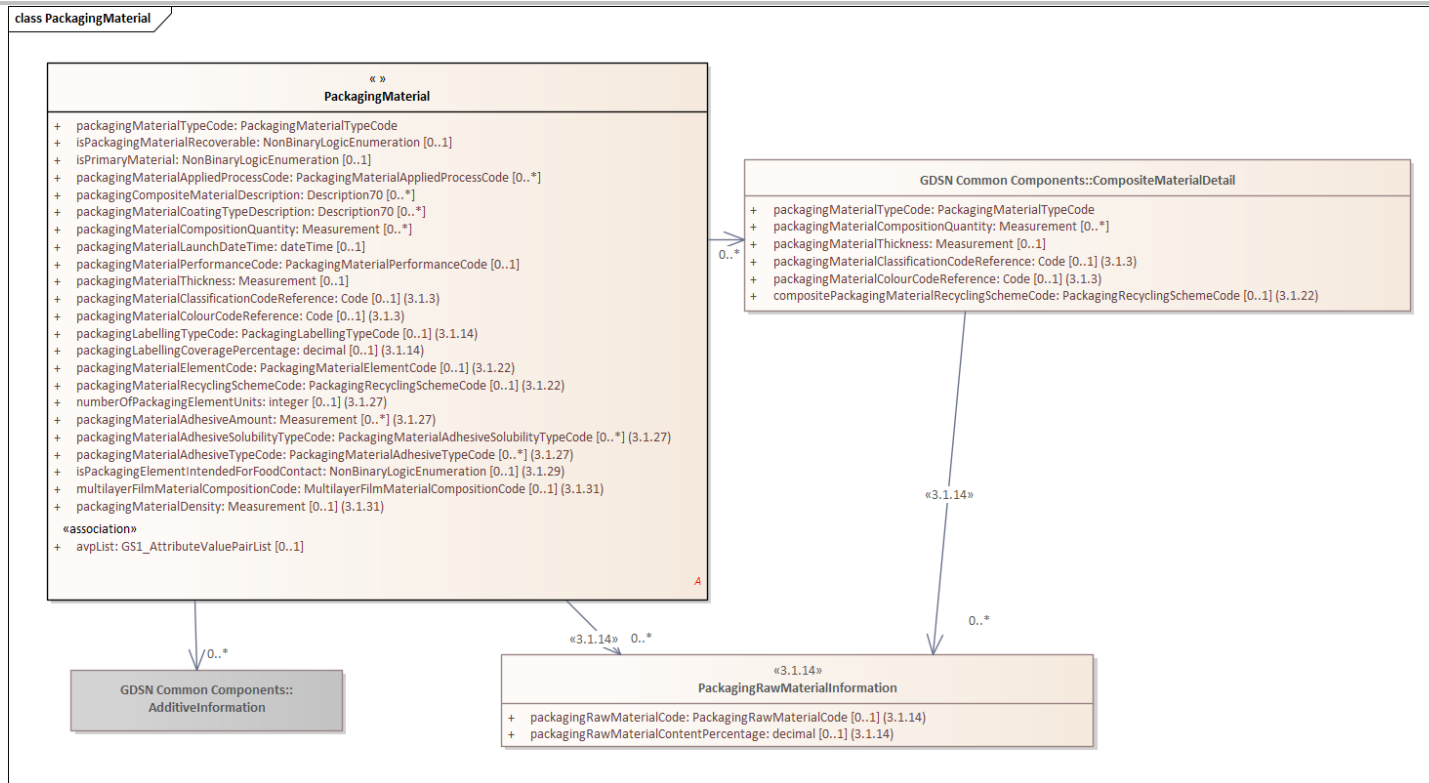

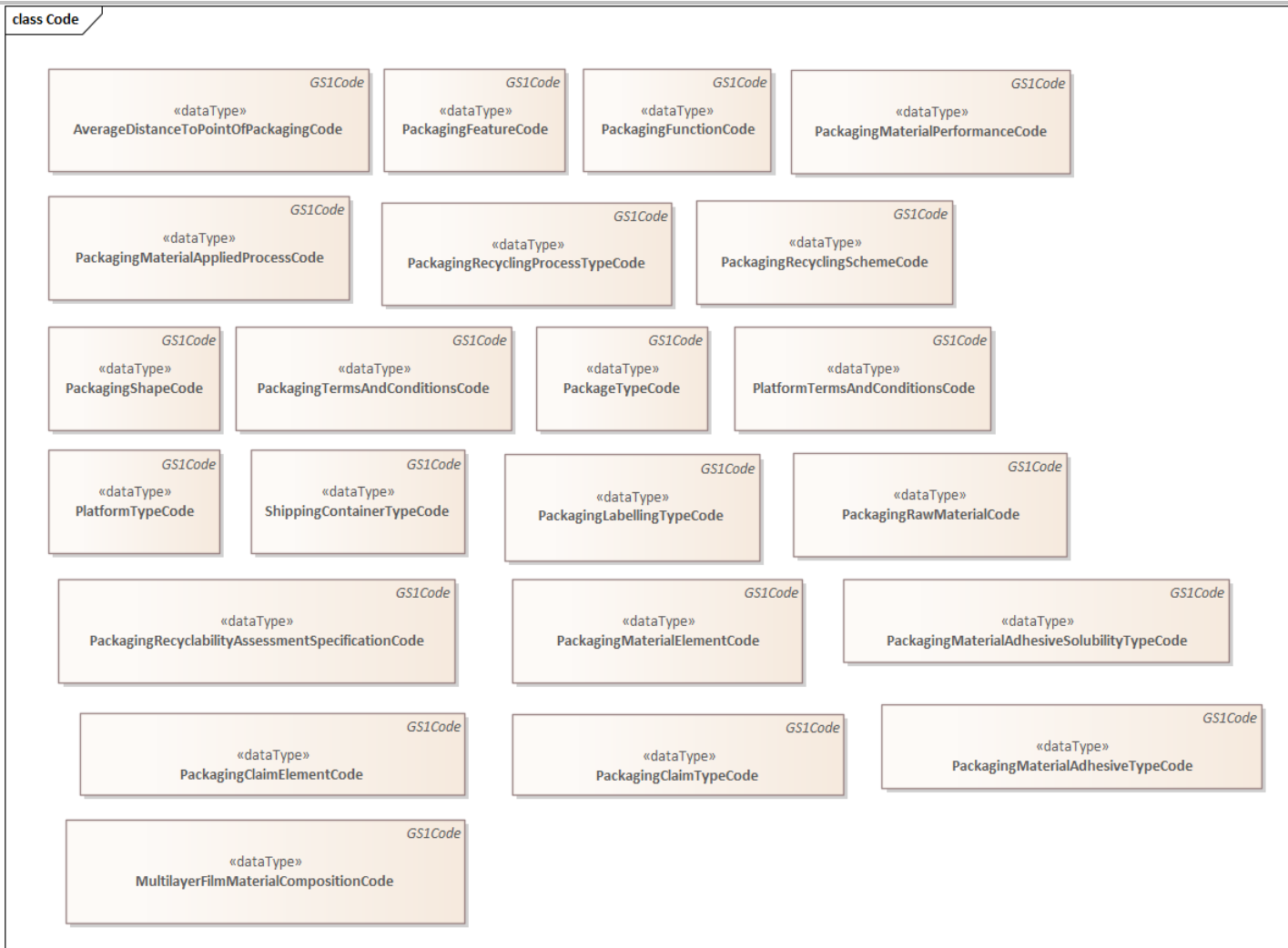

content	attribute / role	datatype /secondary class	multi plicity	definition
PackagingInformationModule				Packaging information for a trade item.
Association		Packaging	0..*	Packaging information for a trade item.
Attribute	doPackagingMaterialsContainLatex	NonBinaryLogicEnumeration	0..1	Identifies if any of the trade item's packaging contains latex.
Attribute	numberOfPackagesForSetPiecesGTIN	nonNegativeInteger	0..1	The total number of separately packaged components comprising a single trade item.
Attribute	packagingSustainabilityStatement	Description1000	0..*	A statement about the trade Item and/or packaging that makes the item sustainable. This may refer to some marketing facing information that is relative to the consumer concerning sustainability for example "Now available in plastic vs. aluminum packaging. Resulting in 15% less energy and 10% waste reduction in manufacturing".
Packaging				Details on packaging for a trade item.
Association		packagingDimension	0..1	Details on the dimensions of a packaging.
Association		PackageDeposit	0..*	Deposit information for packaging.
Association		PackagingMaterial	0..*	Details on packaging material for a trade item's packaging.
Association		ReturnableAsset	0..*	Returnable asset information for a trade item's packaging.
Association		PackagingDividerInformation	0..*	Information on the type and placements of dividers used within the packaging.
Association	avpList	GS1_AttributeValuePairList	0..1	The transmission of non-standard data done in a simple, flexible, and easy to use method.
Attribute	averageDistanceTravelledToPointOfPackagingCode	AverageDistanceToPointOfPackagingCode	0..1	The average distance each packaging material travelled from the packaging material supplier to the point where the product and packaging are combined to form the trade item.
Attribute	doesPackagingHaveWheels	NonBinaryLogicEnumeration	0..1	Indicates if packaging has wheels to facilitate its transportation. Wheels can be permanently fixed or could be detachable. This could apply to a number of packaging types such as trays, cages, boxes, etc.
Attribute	industrySpecificPackagingTypeCodeReference	Code	0..1	A code describing packaging types specific to an industry for example alcoholic beverages. This attribute is populated

content	attribute / role	datatype /secondary class	multi plicit y	definition
				using a Local Code List (LCL). Example: Growler a jug type used in the alcohol beer industry.
Attribute	isPackagingExemptFromRefuseObligation	NonBinaryLogicEnumeration	0..1	An indication for the packaging of this item that there exists an exemption from refuse (disposal) obligations.
Attribute	isPackagingReturnable	NonBinaryLogicEnumeration	0..1	Trade item has returnable packaging. True equals package can be returned. This attribute applies to returnable packaging with or without deposit.
Attribute	isPackagingSuitableForAirShipment	NonBinaryLogicEnumeration	0..1	Determines whether or not the packaging is suitable for air shipment for passenger or cargo for example has it been air pressure tested.
Attribute	isRadioFrequencyIDOnPackaging	boolean	0..1	Indicates that the packaging of the trade item is tagged with a Radio Frequency ID.
Attribute	packagingFeatureCode	PackagingFeatureCode	0..*	A packaging feature that facilitates the usage of the product by the consumer. Features do not affect the core composition of the packaging type nor modify its usage.
Attribute	packagingFunctionCode	PackagingFunctionCode	0..*	A code that is used to identify specific functionality for packaging resulting from specific processes or features present in the packaging type. These additional functionalities are not dependant on the packaging type and maybe applied to multiple different types.
Attribute	packagingLevel	nonNegativeInteger	0..1	Identifies the hierarchical level of the packaging element, i.e. 1,2,3. For example: a bottle in a cardboard box displayed on a shelf. The level 1 hierarchical level is the bottle (plastic or glass), the 2 level would be the box (cardboard), and the 3 level would be the film around the pallet.
Attribute	packagingOwnerIdentification	GLN	0..1	The GLN of the owner of the packaging.
Attribute	packagingOwnerName	string	0..1	The name of the owner of the packaging.
Attribute	packagingRecyclingProcessTypeCode	PackagingRecyclingProcessTypeCode	0..*	The process the packaging could undertake for recyclable & sustainability programs. Examples COMPOSTABLE, ENERGY_RECOVERABLE, REUSABLE.
Attribute	packagingRecyclingSchemeCode	PackagingRecyclingSchemeCode	0..*	A code determining the recycling scheme the packaging of this trade item will fall within when recycled. Applies to recyclable packaging with or without deposit.
Attribute	packagingRefundObligationName	string	0..*	The refund obligation that the packaging of this item is subject to for example the DPG = Deutsche Pfandsystem

content	attribute / role	datatype /secondary class	multi plicit y	definition
				GmbH which is a refund obligation for one way beverage packaging for beer, sparkling soft drinks and mineral water.
Attribute	packagingRefuseObligationName	string	0..*	The name of the specific refuse obligation that may apply to packaging or that the packaging may be exempt from for example ARA.
Attribute	packagingShapeCode	PackagingShapeCode	0..1	A code depicting the shape of a package for example cone.
Attribute	packagingSustainabilityFeatureCode	SustainabilityFeatureCode	0..*	A feature of the packaging that contributes to sustainability initiatives for example that it is made from renewable materials.
Attribute	packagingTermsAndConditionsCode	PackagingTermsAndConditionsCode	0..*	Indicates if the packaging given in the described packaging configuration is a rented, exchangeable, against deposit or one way/not reusable.
Attribute	packagingTypeCode	PackageTypeCode	0..1	The dominant means used to transport, store, handle or display the trade item as defined by the data source. This packaging is not used to describe any manufacturing process. Data recipients can use this data for: <ul style="list-style-type: none"> • Space Planning • Data Accuracy (Tolerances) • Supply Chain processes • Recycling process (In combination with packaging materials) • Product buying/procurement decisions • Tax calculations/fees/duties calculation
Attribute	packagingTypeDescription	Description200	0..*	A text description of the type of packaging used for the trade item.
Attribute	packagingWeight	Measurement	0..1	Used to identify the measurement of the packaging weight of the trade item
Attribute	platformTermsAndConditionsCode	platformTermsAndConditionsCode	0..1	Indicates if the platform in the prescribed pallet configuration is rented, exchangeable, against deposit or one way (not reusable).
Attribute	platformTypeCode	PlatformTypeCode	0..1	Indicates whether the described despatch unit is delivered on a pallet/platform and on which type of platform. If the despatch unit is delivered on a platform, the platform type must be given here. The range of the platform types/codes is listed in code sets.

content	attribute / role	datatype /secondary class	multi plicit y	definition
Attribute	usableProductVolume	Measurement	0..1	The cubic space occupied by the product excluding the packaging. This is measured as the smallest theoretical space the product will fit into. For example: Liquid - a 12 fluid ounce soda has a product volume of 12 fluid ounces or 21.7 cubic inches within the can. Solids by count- a 50ct bottle of tablets (where 1000 tablets requires 1000 cubic centimetre has a product volume of 50 cubic centimetres or 3.1cubic inches, Solids by weight-a 5kg bag of sugar (with a bulk density of .849 g/cubic centimetres has a product volume of 5.889 cubic centimetres or 359.4 cubic inches.
CompositeMaterialDetail				Details on the materials that make up a composite material.
Association		PackagingRawMaterialInformation	0..*	A set of attributes describing the raw material(s) information of a particular packaging material.
Attribute	compositePackagingMaterialRecyclingSchemeCode	PackagingRecyclingSchemeCode	0..1	The code that specifies the recycling scheme the packaging of this trade item will fall within when recycled. Applies to recyclable packaging with or without deposit
Attribute	packagingMaterialTypeCode	PackagingMaterialTypeCode	1..1	The materials used for the packaging of the trade item for example glass or plastic. This material information can be used by data recipients for: o Tax calculations/fees/duties calculation o Carbon footprint calculations/estimations (resource optimisation) o to determine the material used.
Attribute	packagingMaterialCompositionQuantity	Measurement	0..*	The quantity of the packaging material of the trade item. Can be weight, volume or surface, can vary by country.
Attribute	packagingMaterialThickness	Measurement	0..1	The thickness of a packaging material.
Attribute	packagingMaterialClassificationCodeReference	Code	0..1	Identifies the packing material classification used in each packaging component. It is assumed that a packaging material classification would be a broader material grouping that other packaging materials would fit under as classified

content	attribute / role	datatype /secondary class	multi plicity	definition
				by a specific agency. This attribute is populated by local code lists.
Attribute	packagingMaterialColourCodeReference	Code	0..1	Identifies the packaging material colour. This attribute is populated by local code lists.
PackagingMaterial				Information on any material used for packaging.
Association		CompositeMaterialDetail	0..*	Details on the materials that make up a composite material.
Association		PackagingRawMaterialInformation	0..*	A set of attributes describing the raw material(s) information of a particular packaging material.
Attribute	multilayerFilmMaterialCompositionCode	MultilayerFilmMaterialCompositionCode	0..1	The code that defines if the multilayered film can be considered as being composed of a mono or multi material, as determined by local regulations.
Attribute	packagingMaterialDensity	Measurement	0..1	The density of the packaging material expressed as its mass per unit volume, e.g., kilograms per cubic metre or pounds per cubic foot.
Attribute	packagingLabellingTypeCode	PackagingLabellingTypeCode	0..1	The type of text coverage of a packaging, e.g. Label, Printed on packaging.
Attribute	packagingLabellingCoveragePercentage	decimal	0..1	Percentage of the print/label or varnish coverage of the packaging.
Attribute	packagingMaterialElementCode	packagingMaterialElementCode	0..1	The code that describes the part or element of the packaging of the product associated to a material or composite material.
Attribute	packagingMaterialRecyclingSchemeCode	PackagingRecyclingSchemeCode	0..1	The code that specifies the recycling scheme the packaging of this trade item will fall within when recycled. Applies to recyclable packaging with or without deposit.

content	attribute / role	datatype /secondary class	multi plicit y	definition
Attribute	packagingMaterialTypeCode	PackagingMaterialTypeCode	1..1	The materials used for the packaging of the trade item for example glass or plastic. This material information can be used by data recipients for: <ul style="list-style-type: none"> o Tax calculations/fees/duties calculation o Carbon footprint calculations/estimations (resource optimisation) o to determine the material used.
Attribute	isPackagingElementIntendedForFoodContact	NonBinaryLogicEnumeration	0..1	The indicator that specifies if the packaging material element is intended to come into contact with food, directly or indirectly. E.g., if any of the following is true: <ul style="list-style-type: none"> • Intended to be brought into contact with food. • Is already in contact with food. • Can reasonably be expected to be brought into contact with food or to transfer their constituents to food under normal or foreseeable conditions of use.
Attribute	isPackagingMaterialRecoverable	NonBinaryLogicEnumeration	0..1	Determines whether packaging material is recoverable. Recoverable materials are those which are capable of being reused or returned to use in the form of raw materials
Attribute	isPrimaryMaterial	NonBinaryLogicEnumeration	0..1	Specifies the primary or majority material in a composite material used for packaging.
Attribute	numberOfPackagingElementUnits	Integer	0..1	The number of units of the associated material element contained in the package.
Attribute	packagingMaterialAdhesiveTypeCode	PackagingMaterialAdhesiveTypeCode	0..*	The code indicating the adhesive used in the packaging or packaging material of the product.
Attribute	packagingMaterialAdhesiveSolubilityTypeCode	PackagingMaterialAdhesiveSolubilityTypeCode	0..*	The code indicating how the adhesive can be dissolved or the adhesive strength of the adhesive is broken down.
Attribute	packagingMaterialAdhesiveAmount	Measurement	0..*	Adhesive amount refers to the quantity or volume of adhesive material that is applied or used in a particular application or process. It represents the total quantity of

content	attribute / role	datatype /secondary class	multi plicit y	definition
				adhesive substance used to bond or join two or more surfaces together.
Attribute	packagingMaterialAppliedProcessCode	PackagingMaterialAppliedProcessCode	0..*	The processes applied to the material or used in the manufacturing of the material to modify/enhance its properties.
Attribute	packagingCompositeMaterialDescription	Description70	0..*	A description of any composite material used in packaging. A composite material is a combination of different material.
Attribute	packagingMaterialCoatingTypeDescription	Description70	0..*	Specifies any coating material that is applied to the packaging material.
Attribute	packagingMaterialCompositionQuantity	Measurement	0..*	The quantity of the packaging material of the trade item. Can be weight, volume or surface, can vary by country.
Attribute	packagingMaterialLaunchDateTime	dateTime	0..1	The first date that a change in packaging material has occurred. This change does not result in a new GTIN at any level of the item hierarchy, such as, an increase or decrease in packaging material and is delivered to the retailer.
Attribute	packagingMaterialPerformanceCode	PackagingMaterialPerformanceCode	0..1	A status of packaging performance based on testing to minimize damage to Trade Items for example 3 (improved packaging performance).
Attribute	packagingMaterialThickness	Measurement	0..1	The thickness of a packaging material.
Attribute	packagingMaterialClassificationCodeReference	Code	0..1	Identifies the packing material classification used in each packaging component. It is assumed that a packaging material classification would be a broader material grouping that other packaging materials would fit under as classified by a specific agency. This attribute is populated by local code lists.
Attribute	packagingMaterialColourCodeReference	Code	0..1	Identifies the packaging material colour. This attribute is populated by local code lists.
Association	avpList	GS1_AttributeValue PairList	0..1	The transmission of non-standard data done in a simple, flexible, and easy to use method.
Association		AdditiveInformation	0..*	Information on presence or absence of additives or genetic modifications contained in the trade item.
PackagingRawMaterialInformation				A set of attributes describing the raw material(s) information of a particular packaging material.

content	attribute / role	datatype /secondary class	multi plicit y	definition
Attribute	packagingRawMaterial Code	PackagingRawMaterialCode	0..1	The code describing the type of raw or recycled material the product packaging material is made from.
Attribute	packagingRawMaterial ContentPercentage	decimal	0..1	The percentage of the type of raw or recycled material the product packaging material is made from, as specified by the Packaging Raw Material Code.
PackageDeposit				Deposit information for a package.
Association	returnablePackageDepositRegion	TargetMarket	0..*	The geographic region associated with the returnable package deposit amount.
Attribute	depositValueEffectiveDate	dateTime	0..1	First date that the deposit value is valid for the deposit code.
Attribute	depositValueEndDate	dateTime	0..1	Last date that the deposit value in the currency is valid for the deposit code.
Attribute	returnablePackageDepositAmount	Amount	0..1	The monetary amount for the individual returnable package.
Attribute	returnablePackageDepositIdentification	Identifier	0..1	In some markets the deposit information is specified by a GTIN giving the type of returnable package on which a deposit is charged. Each deposit code is associated with an amount specified elsewhere. The enumeration list is maintained externally.
attribute	packagingRefundObligationName	string	0..*	The refund obligation that the packaging of this item is subject to for example the DPG = Deutsche Pfandsystem GmbH which is a refund obligation for one way beverage packaging for beer, sparkling soft drinks and mineral water.
PackagingDivider Information				Information on the type and placements of dividers used within the packaging.
attribute	numberOfDividersHorizontal	nonNegativeInteger	0..1	Specifies the number of internal dividers that separate one layer from another in a trade item (applies to any level with multiple children (pack/case/pallet). For example, 2 means there is a total of two horizontal dividers in the configuration.
attribute	numberOfDividersVertical	nonNegativeInteger	0..1	Specifies the number of vertical internal dividers that separate trade items within a layer in the internal configuration (applies to any level with multiple children: pack/case/pallet).
attribute	placementOfDivider	nonNegativeInteger	0..*	Indicates layer number that the dividers are found. Layer dividers are always counted starting at the uppermost layer (top to bottom) or leftmost divider (Left to right). For

content	attribute / role	datatype /secondary class	multi plicit y	definition
				example "3", "5" would mean that the 2 dividers are located on the 3rd and 5th layer counting always from the top to bottom.
PackagingClaims				Details on a claim for the packaging. In some markets permitted by regulations.
Attribute	packagingClaimElementCode	PackagingClaimElementCode	0..1	The code that indicates an element in the product packaging that is subject to the claim specified by the Packaging Claim Type Code.
Attribute	isPackagingClaimMarkedOnPackage	Boolean	0..1	The indicator that specifies whether the claim specified by Packaging Claim Type Code in combination with Packaging Claim Element Code is stated/claimed on the product package.
Attribute	isPackagingClaimRegulated	Boolean	0..1	The indicator that specifies whether the claim for the packaging is regulated for the target market.
Attribute	packagingClaimTypeCode	PackagingClaimTypeCode	0..1	The code that states the type of claim relevant to the Packaging Claim Element Code.
PackagingDimension				Details on the dimensions of a packaging.
Attribute	packagingDepth	Measurement	0..1	The depth of the packaging, as measured according to the GS1 Package and Product Measurement Standard. If the packaging dimensions are for a platform or pallet, the measurements for the platform or pallet itself are provided based on the orientation and tolerances for non-consumer trade items.
Attribute	packagingHeight	Measurement	0..1	The height of the packaging, as measured according to the GS1 Package and Product Measurement Standard. If the packaging dimensions are for a platform or pallet, the measurements for the platform or pallet itself are provided based on the orientation and tolerances for non-consumer trade items.
Attribute	packagingWidth	Measurement	0..1	The width of the packaging, as measured according to the GS1 Package and Product Measurement Standard. If the packaging dimensions are for a platform or pallet, the measurements for the platform or pallet itself are provided based on the orientation and tolerances for non-consumer trade items.
ReturnableAsset				Returnable asset information for a package.
Association	returnableAssetPackageDeposit	PackageDeposit	0..*	Package deposit information for a package.

content	attribute / role	datatype /secondary class	multi plicit y	definition
Attribute	alternativeReturnable AssetIdentification	AdditionalReturnabl eAssetIdentification	0..*	An additional returnable asset identification type. Allowed code values are specified in GS1 Code List AdditionalReturnableAssetIdentificationTypeCode.
Attribute	grai	GRAI	0..1	The GS1 Identification Key used to identify Returnable Assets. The key comprises a GS1 Company Prefix, Asset Type, Check Digit, and optional serial number.
Attribute	isReturnableAssetEmp ty	NonBinaryLogicEnu meration	0..1	Determines whether the returnable asset is empty.
Attribute	returnableAssetCapaci tyContent	Measurement	0..*	A measurement of the potential capacity of a returnable asset for example how many bottles can fit into a crate. This is not the content for the full packaging but rather how much the packaging can contain.
Attribute	returnableAssetsConta inedQuantity	Quantity	0..*	The number of returnable assets contained that are allocated to the full returnable item identified by the GTIN of the returnable asset. An example would be 6 bottles of beer in a six pack (Trade Item).
Attribute	returnableAssetOwner Id	GLN	0..1	The GLN of the owner of a returnable asset.
Attribute	returnableAssetOwner Name	string	0..1	The name of the owner of a returnable asset.
NumberOfUnitIn ShippingContain er				Information on the number of units contained in a shipping container.
Attribute	shippingContainerQua ntity	TransactionalMeasur ement	0..*	The quantity of units contained in a shipping container for example 75 cases (75 CA).
Attribute	shippingContainerQua ntityDescription	Description200	0..*	The quantity of the contents of the shipping container as described on the outside of the shipping container, for example 100 .5 oz envelopes.
Attribute	shippingContainerType Code	ShippingContainerT ypeCode	0..1	The type and size of the container in which the trade items composing the standard transport load (identified by a unique GTIN) are shipped by the consignor for international transport. This attribute should be populated using the ISO 6346 recommendation to indicate size and type codes of the shipping container. This code refers to the type of container and not the items inside. The first digit is the length of the

content	attribute / role	datatype /secondary class	multi plicity	definition
				container, the second is the height of the container, and the last two are the container type.
PackagingRecyclabilityAssessmentInformation				This class includes attributes to provide the recyclability assessment of an item's packaging on the packaging level.
Attribute	packagingRecyclabilityAssessmentSpecificationCode	PackagingRecyclabilityAssessmentSpecificationCode	0..1	The code that identifies the specification that defines how the degree of recyclability of packaging is calculated during assessment. These can be an agency, a regulation or directive, a community agreement, etc.
Attribute	packagingRecyclabilityValue	Measurement	0..*	The value that indicates the degree of recyclability of an item's packaging, which is calculated on the basis of the standard chosen in packagingRecyclabilityAssessmentSpecificationCode. This can be a percentage or value and can vary by country.
Attribute	packagingRecyclabilityValueEffectiveDate	dateTime	0..1	The first date that the item with this packaging is available.

5.43 Packaging Marking Module

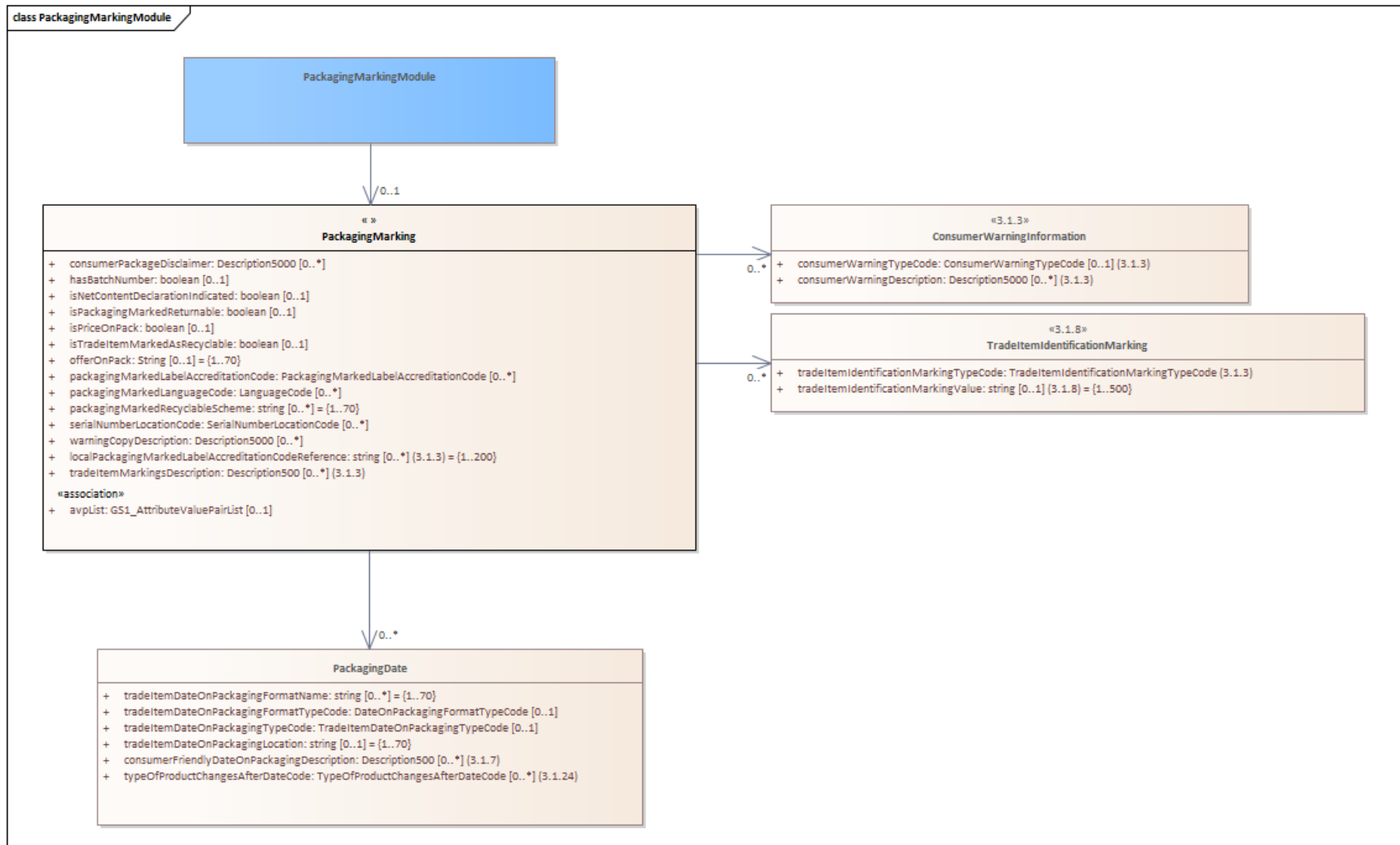

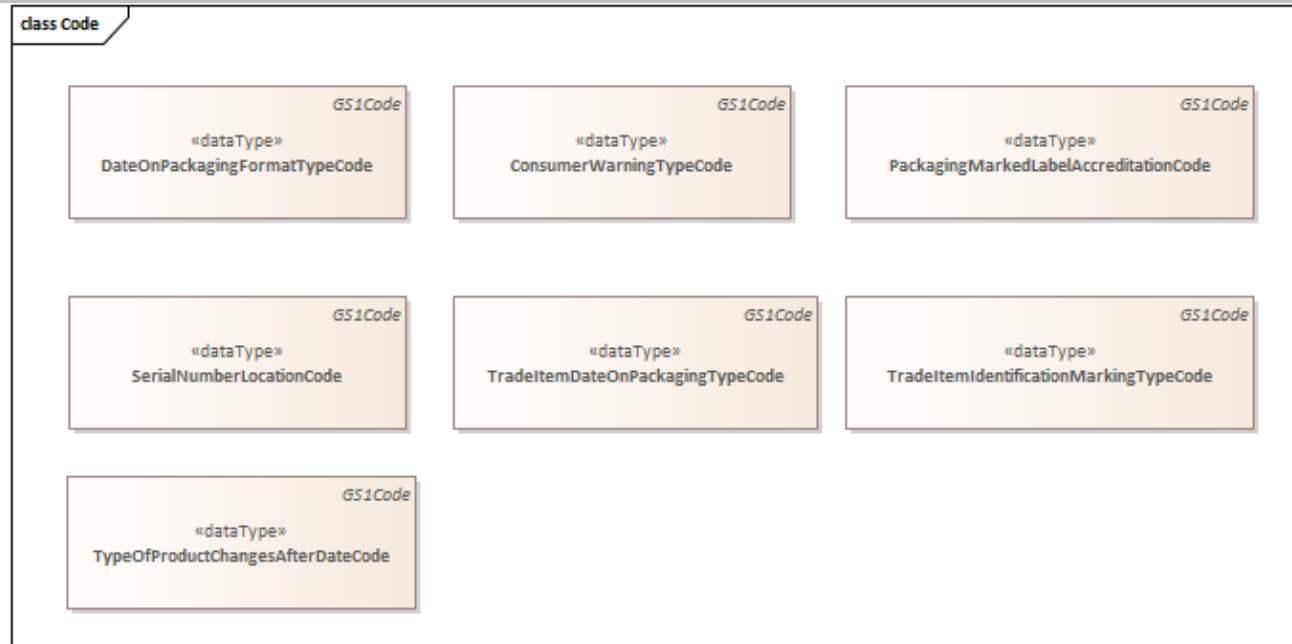

content	attribute / role	datatype /secondary class	multiplicity	definition
ConsumerWarningInformation				Information on specific warnings for consumers for example maximum weight.
Attribute	consumerWarningTypeCode	ConsumerWarningTypeCode	0..1	Indicate if the warning information given in the consumer warning description concerns a specific distinctive feature/ability of the user as age (e.g. Minimum Age 3 years) or weight (e.g. Maximum Weight 20 Kilogram).
Attribute	consumerWarningDescription	Description5000	0..*	A description associated with a specific warning type for example if the consumerWarningTypeCode is AGE, the consumerWarningDescription would be "For ages 15 and over".
PackagingDate				Details on date markings on the packaging of the trade item.
Attribute	consumerFriendlyDateOnPackagingDescription	Description500	0..*	The exact textual type of date on the packaging. Examples: Used By, Freeze By, Exp Date, Best Before, etc.

content	attribute / role	datatype /secondary class	multiplicity	definition
Attribute	typeOfProductChangesAfterDateCode	TypeOfProductChangesAfterDateCode	0..*	The code describing the changes that occur to the product after the marked date on package or item. The product may no longer be usable, provide benefit, suffer quality degradation or may still be usable but without guarantee or unable to provide all described functionality.
Attribute	tradeItemDateOnPackagingFormatName	string	0..*	The format that the date is printed on the package for example YYYY: year, YY: year in century, MM: month number, MMM: month short name, WW: week of year, DD: day of month, D: day of week (Monday=1), ' ': space and hyphen.
Attribute	tradeItemDateOnPackagingFormatTypeCode	DateOnPackagingFormatTypeCode	0..1	A category of date formats for example calendar or ordinal date.
Attribute	tradeItemDateOnPackagingTypeCode	TradeItemDateOnPackagingTypeCode	0..1	Indicates the type of date marked on the packaging for example Best Before Date.
Attribute	tradeItemDateOnPackagingLocation	string	0..1	Free text detailing the location of the date marking on the packaging.
PackagingMarkingModule				A module containing details on markings on the packaging of the trade item for example dates, environment.
Association		PackagingMarking	0..1	Details on markings on the packaging of the trade item for example dates, environment.
PackagingMarking				Details on markings on the packaging of the trade item for example dates, environment.
Association		PackagingDate	0..*	Details on date markings on the packaging of the trade item.
Association		ConsumerWarningInformation	0..*	Information on specific warnings for consumers for example maximum weight.
Association		TradeItemIdentificationMarking	0..*	The specific identification the item and/or its packaging is marked with.
Association	avpList	GS1_AttributeValuePairList	0..1	The transmission of non-standard data done in a simple, flexible, and easy to use method.
Attribute	consumerPackageDisclaimer	Description5000	0..*	Additional information that should be used in advertising and in displaying.

content	attribute / role	datatype /secondary class	multiplicity	definition
Attribute	hasBatchNumber	boolean	0..1	Indication whether the base trade item is batch or lot number requested by law, not batch or lot number requested by law but batch or lot number allocated, or not batch or lot number allocated. A batch or lot number is a manufacturer assigned code used to identify a trade item's trade item on batch or lot. Differs from Serial Number which is a manufacturer assigned code during the trade item on cycle to identify a unique trade item.
Attribute	isNetContentDeclarationIndicated	boolean	0..1	This field is used to facilitate local business rules where a declaration of a trade item's net content is not on the product label e.g.UK under 50g.legislation.
Attribute	isPackagingMarkedReturnable	boolean	0..1	Trade item has returnable packaging. This is a yes/no (Boolean) where yes equals package can be returned. Attribute applies to returnable packaging with or without deposit.
Attribute	isPriceOnPack	boolean	0..1	Indication of whether there is a retail price physically on or attached to the trade item packaging of the trade item by the manufacturer or information provider.
Attribute	isTradeItemMarkedAsRecyclable	boolean	0..1	Trade item has a recyclable indication marked on it. This may be a symbol from one of many regional agencies.
Attribute	offerOnPack	string	0..1	Contains details of any on pack product offer (consumer or traded).
Attribute	packagingMarkedLabelAccreditationCode	PackagingMarkedLabelAccreditationCode	0..*	A marking, on a label, that the trade item received recognition, endorsement, certification by following guidelines by the label issuing agency. This does not represent regulatory labels like CE, Ɂ .
Attribute	packagingMarkedLanguageCode	LanguageCode	0..*	The language in which text on the packaging is stated.
Attribute	packagingMarkedRecyclableScheme	string	0..*	The package of this GTIN is marked to indicate under which scheme it is recyclable. Applies to recyclable packaging with or without deposit. Examples: Aluminium can be marked as recyclable.

content	attribute / role	datatype /secondary class	multiplicity	definition
Attribute	serialNumberLocationCode	SerialNumberLocationCode	0..*	The location on the item or packaging of a serial number. A serial number is a code, numeric or alphanumeric, assigned to an individual instance of an entity for its lifetime for example a Microscope model AC-2 with serial number 1234568 and microscope model AC-2 with serial number 1234569.
Attribute	warningCopyDescription	Description5000	0..*	Warning information is additional information that outlines special requirements, warning and caution information printed on the package.
Attribute	localPackagingMarkedLabelAccreditationCodeReference	string	0..*	Used for markings on package that are locally managed and are not regulatory in nature. Use local code lists to populate this attribute.
Attribute	tradeItemMarkingsDescription	Description500	0..*	Describes the distinctive direct marking(s) or imprints on a trade item and the location of the markings as described by the manufacturer for example a company logo on front, value with UOM on back and scored.
TradeItemIdentificationMarking				The specific identification the item and/or its packaging is marked with.
Attribute	tradeItemIdentificationMarkingTypeCode	TradeItemIdentificationMarkingTypeCode	1..1	A code determining whether the item and/or its packaging is marked with a specific identification.
Attribute	tradeItemIdentificationMarkingValue	string	0..1	The specific identification the item and/or its packaging is marked with.

5.44 Packaging Sustainability Module

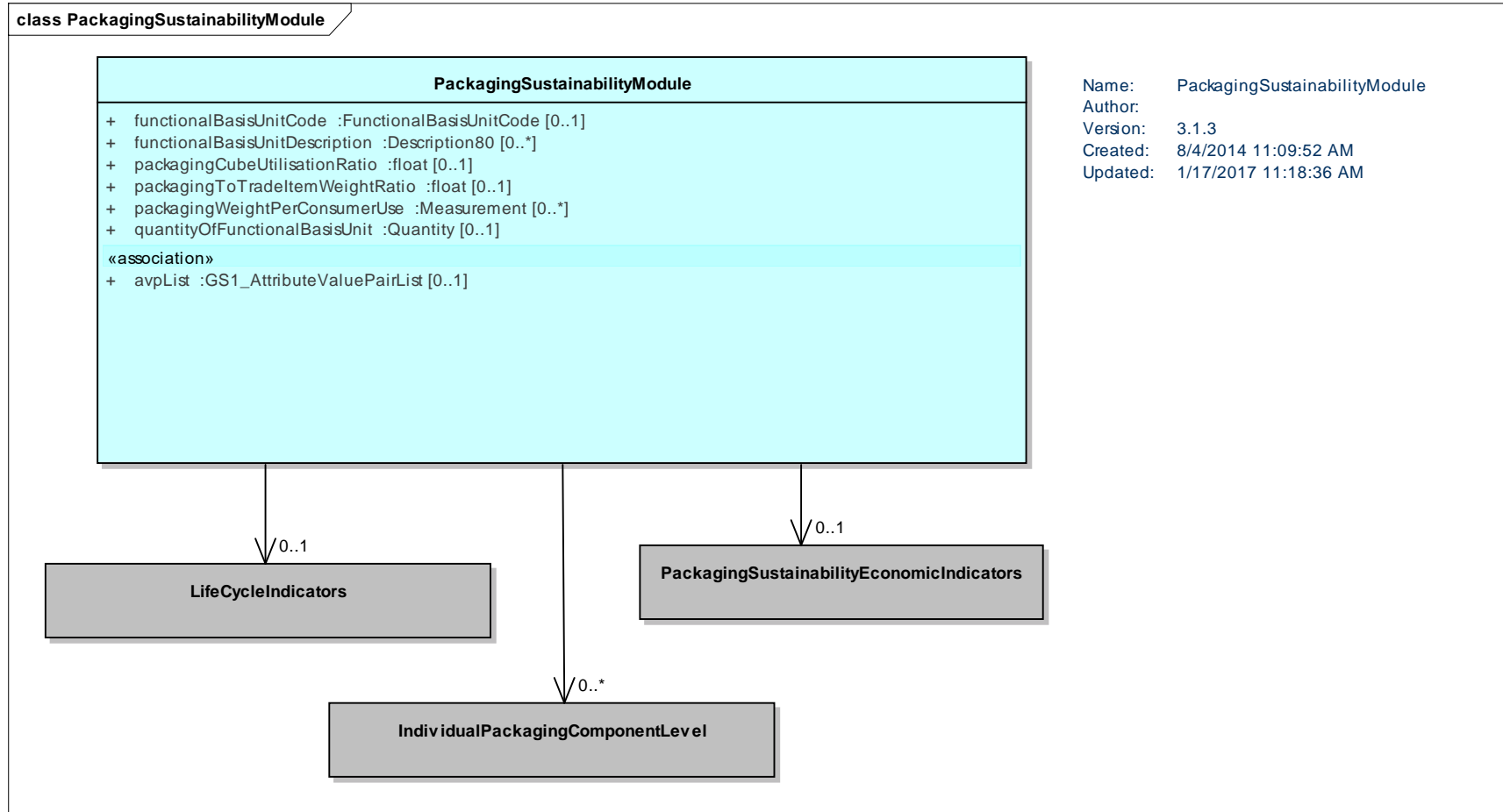

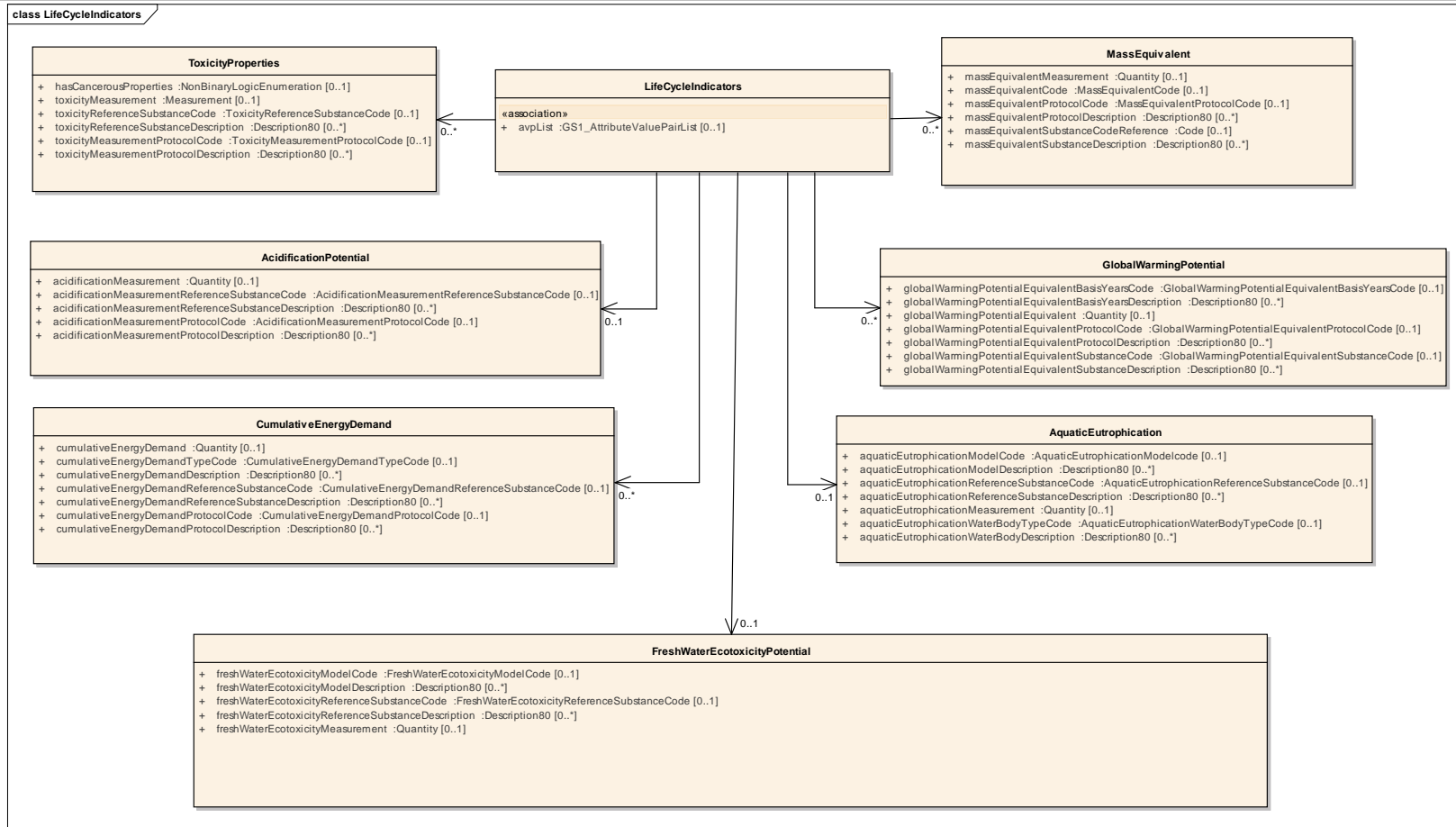

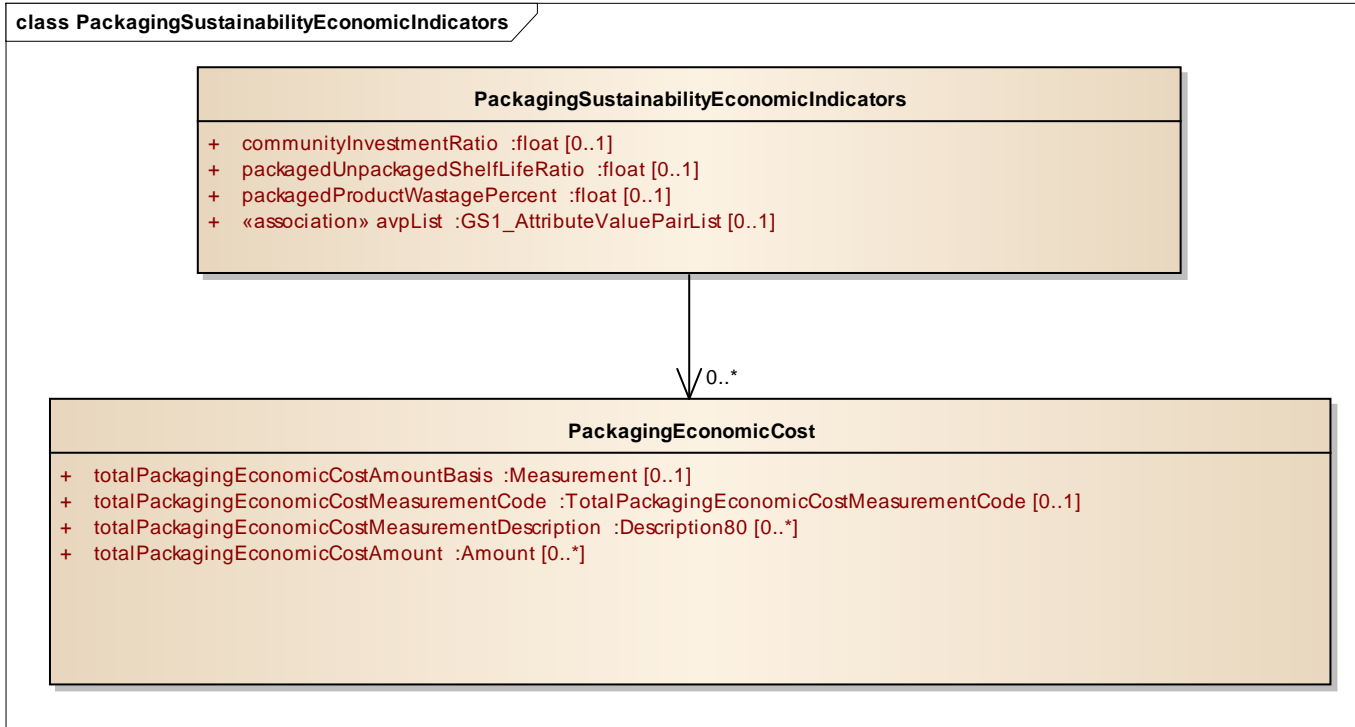

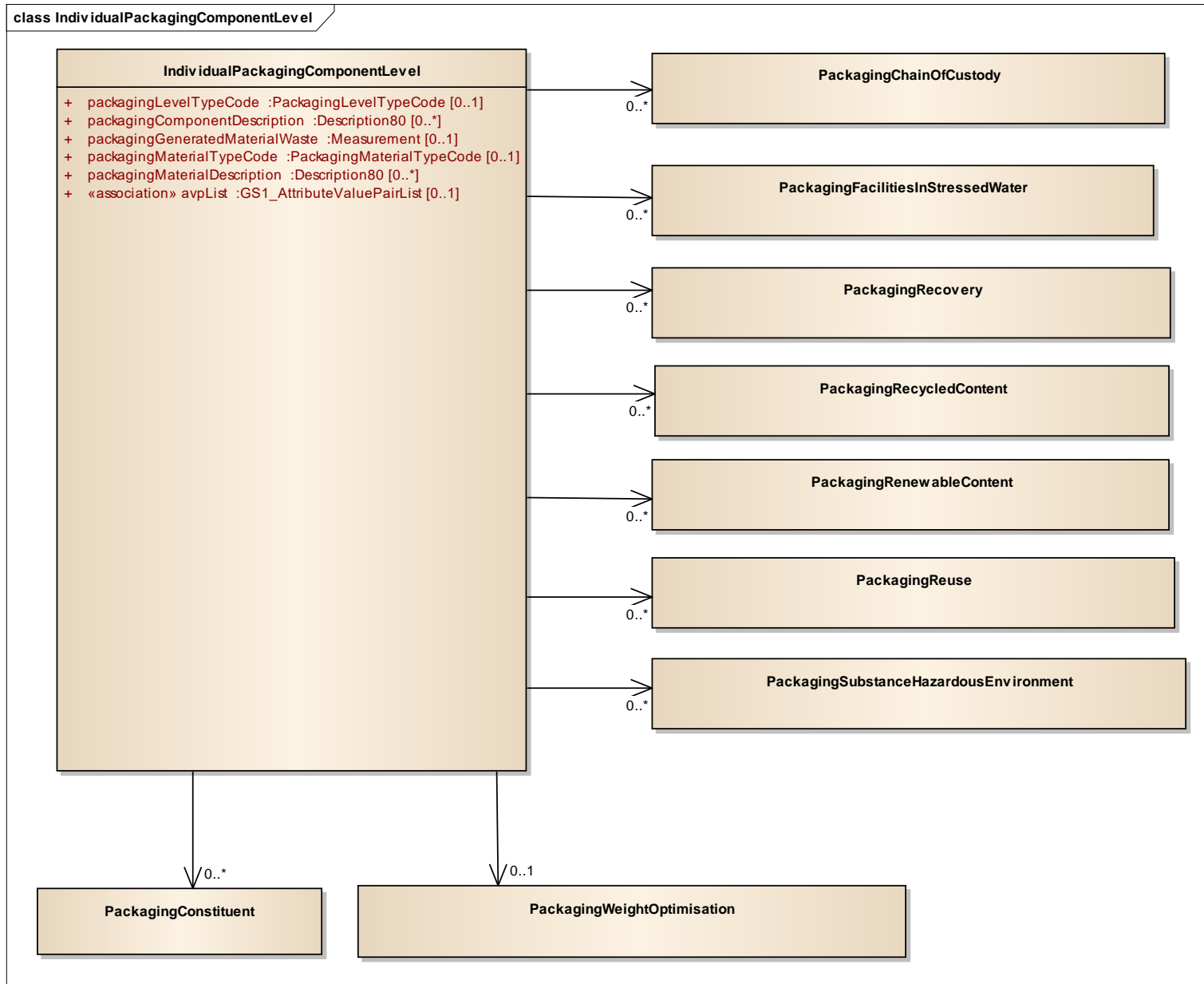

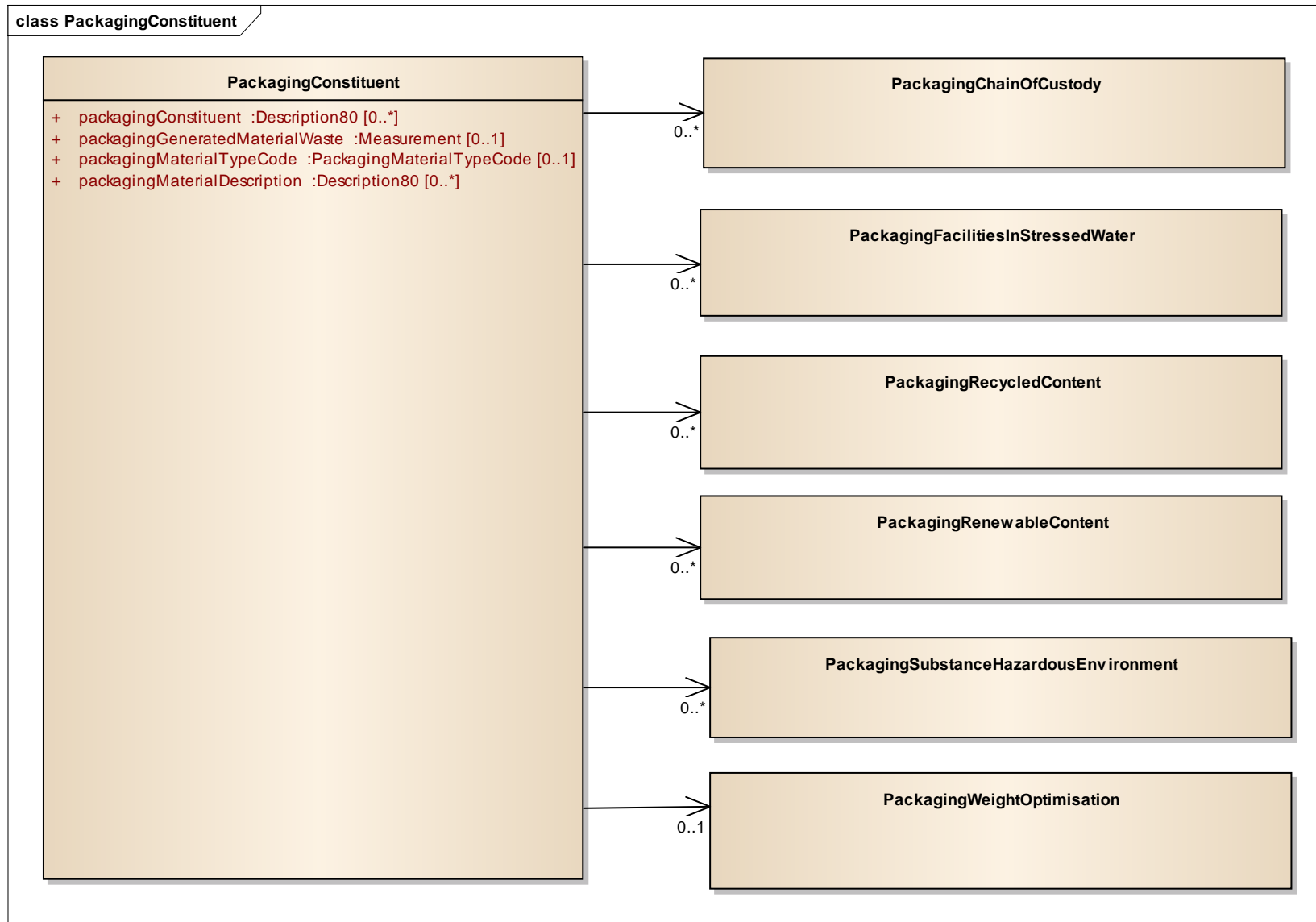

class Packaging_Sustainability_Module_Classes

PackagingChainOfCustody

- + packagingChainOfCustodyEventSequenceNumber :nonNegativeInteger [0..1]
- + packagingChainOfCustodySourceCertifiedCode :PackagingChainOfCustodySourceCertifiedCode [0..1]
- + sourceCertificationSystemProtocolCode :SourceCertificationSystemProtocolCode [0..1]
- + sourceCertificationSystemProtocolDescription :Description80 [0..*]

PackagingFacilitiesInStressedWater

- + facilitiesInStressedWaterAreaPercent :float [0..1]
- + facilitiesInStressedWaterAreaCalculationMethod :Description200 [0..*]
- + numberOfFacilitiesInStressedWaterArea :nonNegativeInteger [0..1]

PackagingRecovery

- + doesPackagingRecoveryRateTypeCodeMeetTheStandard :NonBinaryLogicEnumeration [0..1]
- + packagingRecoveryRate :float [0..1]
- + packagingRecoveryRateDescription :Description80 [0..*]
- + packagingRecoveryRateTypeCode :PackagingRecoveryRateTypeCode [0..1]
- + totalPackagingRecoveryRate :float [0..1]

PackagingRecycledContent

- + packagingRecycledContentRatio :float [0..1]
- + packagingRecycledContentTypeCode :PackagingRecycledContentTypeCode [0..1]
- + packagingRecycledContentDescription :Description80 [0..*]

PackagingRenewableContent

- + packagingRenewableContentRatio :float [0..1]
- + packagingRenewableContentTypeCode :PackagingRenewableContentTypeCode [0..1]
- + packagingRenewableContentDescription :Description80 [0..*]

PackagingReuse

- + numberOfCyclesPriorToWithdrawal :nonNegativeInteger [0..1]
- + packagingReuseRate :float [0..1]
- + packagingReusabilityStandardCode :PackagingReusabilityStandardCode [0..1]
- + packagingReusabilityStandardDescription :Description80 [0..*]

PackagingSubstanceHazardousEnvironment

- + haveYouMinimizedHazardousSubstance :NonBinaryLogicEnumeration [0..1]
- + hazardousSubstancesMinimizationCode :HazardousSubstancesMinimizationCode [0..1]
- + relevantSupportingSubstanceHazardousDocumentation :Description200 [0..*]

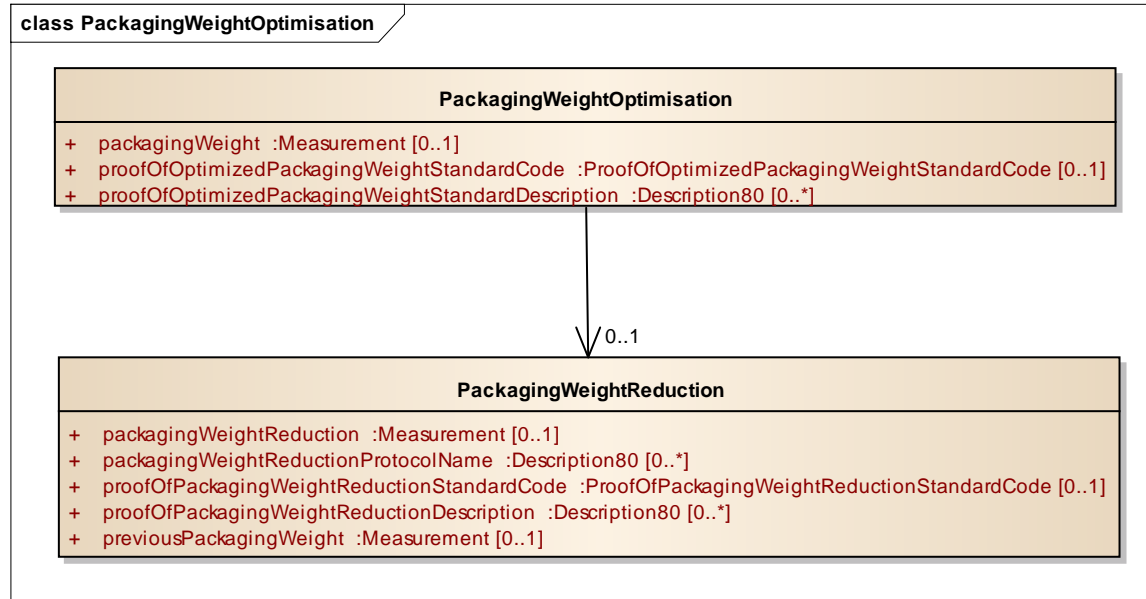

class Code			
<p>GS1Code</p> <p>«data Type»</p> <p>AcidificationMeasurementProtocolCode</p>	<p>GS1Code</p> <p>«data Type»</p> <p>AcidificationMeasurementReferenceSubstanceCode</p>	<p>GS1Code</p> <p>«data Type»</p> <p>AquaticEutrophicationModelCode</p>	<p>GS1Code</p> <p>«data Type»</p> <p>AquaticEutrophicationReferenceSubstanceCode</p>
<p>GS1Code</p> <p>«data Type»</p> <p>AquaticEutrophicationWaterBodyTypeCode</p>	<p>GS1Code</p> <p>«data Type»</p> <p>CumulativeEnergyDemandProtocolCode</p>	<p>GS1Code</p> <p>«data Type»</p> <p>CumulativeEnergyDemandReferenceSubstanceCode</p>	<p>GS1Code</p> <p>«data Type»</p> <p>CumulativeEnergyDemandTypeCode</p>
<p>GS1Code</p> <p>«data Type»</p> <p>FreshWaterEcotoxicityModelCode</p>	<p>GS1Code</p> <p>«data Type»</p> <p>FreshWaterEcotoxicityReferenceSubstanceCode</p>	<p>GS1Code</p> <p>«data Type»</p> <p>FunctionalBasisUnitCode</p>	<p>GS1Code</p> <p>«data Type»</p> <p>GlobalWarmingPotentialEquivalentProtocolCode</p>
<p>GS1Code</p> <p>«data Type»</p> <p>GlobalWarmingPotentialEquivalentSubstanceCode</p>	<p>GS1Code</p> <p>«data Type»</p> <p>GlobalWarmingPotentialEquivalentBasisYearsCode</p>	<p>GS1Code</p> <p>«data Type»</p> <p>HazardousSubstancesMinimizationCode</p>	<p>GS1Code</p> <p>«data Type»</p> <p>MassEquivalentCode</p>
<p>GS1Code</p> <p>«data Type»</p> <p>MassEquivalentProtocolCode</p>	<p>GS1Code</p> <p>«data Type»</p> <p>PackagingChainOfCustodySourceCertifiedCode</p>	<p>GS1Code</p> <p>«data Type»</p> <p>PackagingLevelTypeCode</p>	
<p>GS1Code</p> <p>«data Type»</p> <p>PackagingRecoveryRateTypeCode</p>	<p>GS1Code</p> <p>«data Type»</p> <p>PackagingRecycledContentTypeCode</p>	<p>GS1Code</p> <p>«data Type»</p> <p>PackagingRenewableContentTypeCode</p>	<p>«data Type»</p> <p>PackagingReusabilityStandardCode</p>
<p>GS1Code</p> <p>«data Type»</p> <p>ProofOfOptimizedPackagingWeightStandardCode</p>	<p>GS1Code</p> <p>«data Type»</p> <p>ProofOfPackagingWeightReductionStandardCode</p>	<p>GS1Code</p> <p>«data Type»</p> <p>SourceCertificationSystemProtocolCode</p>	<p>GS1Code</p> <p>«data Type»</p> <p>TotalPackagingEconomicCostMeasurementCode</p>
<p>GS1Code</p> <p>«data Type»</p> <p>ToxicityMeasurementProtocolCode</p>	<p>GS1Code</p> <p>«data Type»</p> <p>ToxicityReferenceSubstanceCode</p>		

content	attribute / role	datatype /secondary class	multiplicity	definition
AcidificationPotential				Acidification Potential is the potential of a chemical emission to acidify ecosystems. Emissions of acidifying substances strongly depend on industrial practice and environmental legislation.
attribute	acidificationMeasurement	Quantity	0..1	The measurement of acidification potential.
attribute	acidificationMeasurementReferenceSubstanceCode	AcidificationMeasurementReferenceSubstanceCode	0..1	The reference substance used to represent the potential to acidify ecosystems.
attribute	acidificationMeasurementReferenceSubstanceDescription	Description 80	0..*	The reference substance description used to represent the potential to acidify ecosystems.
attribute	acidificationMeasurementProtocolCode	AcidificationMeasurementProtocolCode	0..1	The reference protocol used to represent the potential to acidify ecosystems.
attribute	acidificationMeasurementProtocolDescription	Description 80	0..*	The reference protocol description used to represent the potential to acidify ecosystems.
AquaticEutrophication				Aquatic Eutrophication occurs when excessive amounts of nutrients reach freshwater systems or oceans. Algae bloom may result and fish may disappear. Whereas phosphorous is mainly responsible for eutrophication in freshwater systems, nitrogen is mainly responsible for eutrophication in ocean water bodies.
attribute	aquaticEutrophicationModelCode	AquaticEutrophicationModelCode	0..1	The model determining the degree of aquatic eutrophication
attribute	aquaticEutrophicationModelDescription	Description 80	0..*	The model description determining the degree of aquatic eutrophication
attribute	aquaticEutrophicationReferenceSubstanceCode	AquaticEutrophicationReferenceSubstanceCode	0..1	The reference substance used to represent aquatic eutrophication potential.
attribute	aquaticEutrophicationReferenceSubstanceDescription	Description 80	0..*	The reference substance used to represent aquatic eutrophication potential.
attribute	aquaticEutrophicationMeasurement	Quantity	0..1	The measurement of Aquatic Eutrophication per functional unit.

content	attribute / role	datatype /secondary class	multiplicity	definition
attribute	aquaticEutrophicationWaterBodyTypeCode	AquaticEutrophicationWaterBodyTypeCode	0..1	The type of water body that aquatic eutrophication is being measured for.
attribute	aquaticEutrophicationWaterBodyDescription	Description 80	0..*	The description of water body that aquatic eutrophication is being measured for.
CumulativeEnergyDemand				Provides the cumulative energy demand information details.
attribute	cumulativeEnergyDemand	Quantity	0..1	CED is a statement of the entire energy demand for a given product or service composed by a renewable part (CEDR) and a non-renewable part (CEDNR).
attribute	cumulativeEnergyDemandTypeCode	CumulativeEnergyDemandTypeCode	0..1	The type of cumulative energy demand that is being measured for.
attribute	cumulativeEnergyDemandDescription	Description 80	0..*	The description of cumulative energy demand that is being measured for.
attribute	cumulativeEnergyDemandReferenceSubstanceCode	CumulativeEnergyDemandReferenceSubstanceCode	0..1	The reference substance used to represent cumulative energy demand.
attribute	cumulativeEnergyDemandReferenceSubstanceDescription	Description 80	0..*	The reference substance description used to represent cumulative energy demand.
attribute	cumulativeEnergyDemandProtocolCode	CumulativeEnergyDemandProtocolCode	0..1	The reference protocol used to represent the potential to cumulative energy demand.
attribute	cumulativeEnergyDemandProtocolDescription	Description 80	0..*	The reference protocol description used to represent the potential to cumulative energy demand.
FreshWaterEcotoxicityPotential				Provides the freshwater ecotoxicity potential information.
attribute	freshWaterEcotoxicityModelCode	FreshWaterEcotoxicityModelCode	0..1	The model used to determine freshwater ecotoxicity.
attribute	freshWaterEcotoxicityModelDescription	Description 80	0..*	The model description used to determine freshwater ecotoxicity.

content	attribute / role	datatype /secondary class	multiplicity	definition
attribute	freshWaterEcotoxicityReferenceSubstanceCode	FreshWaterEcotoxicityReferenceSubstanceCode	0..1	The reference substance used to represent freshwater ecotoxicity.
attribute	freshWaterEcotoxicityReferenceSubstanceDescription	Description 80	0..*	The reference substance description used to represent freshwater ecotoxicity.
attribute	freshWaterEcotoxicityMeasurement	Quantity	0..1	The measurement of freshwater ecotoxicity according to the following formula: kg [chemical reference] eq / FU.
GlobalWarmingPotential				Provides the global warming potential information.
attribute	globalwarmingPotentialEquivalentBasisYearsCode	GlobalWarmingPotentialEquivalentBasisYearsCode	0..1	The time perspective over which global warming potential is considered (20, 100, 500 years). Use the characterization factors of the 4th assessment report of the Intergovernmental Panel on Climate Change (IPCC). A 100 year time perspective is recommended. The time perspective chosen should always be communicated together with the metric.
attribute	globalwarmingPotentialEquivalentBasisYearsDescription	Description 80	0..*	The time perspective description over which global warming potential is considered. Use the characterization factors of the 4th assessment report of the Intergovernmental Panel on Climate Change (IPCC). A 100 year time perspective is recommended. The time perspective chosen should always be communicated together with the metric.
attribute	globalwarmingPotentialEquivalent	Quantity	0..1	The associated mass of CO2 equivalents associated with the Functional Unit.
attribute	globalwarmingPotentialEquivalentProtocolCode	GlobalWarmingPotentialEquivalentProtocolCode	0..1	The reference protocol used to represent the potential to global warming.
attribute	globalwarmingPotentialEquivalentProtocolDescription	Description 80	0..*	The reference protocol description used to represent the potential to global warming.
attribute	globalwarmingPotentialEquivalentSubstanceCode	GlobalWarmingPotentialEquivalentSubstanceCode	0..1	The reference substance used to represent the potential to global warming.
attribute	globalwarmingPotentialEquivalentSubstanceDescription	Description 80	0..*	The reference protocol description used to represent the potential to global warming.
IndividualPackagingComponentLevel				Provides the individual packaging components details.

content	attribute / role	datatype /secondary class	multiplicity	definition
Association		PackagingRecycledContent	0..*	Provides the recycled content information.
Association		PackagingChainOfCustody	0..*	Provides the chain of custody information.
Association		PackagingFacilitiesInStressedWater	0..*	Provides the facilities in stress water information.
Association		PackagingRecovery	0..*	Provides the packaging recovery information
Association		PackagingConstituent	0..*	Provides the packaging constituent information.
Association		PackagingReuse	0..*	Provides the packaging reuse information
Association		PackagingSubstanceHazardousEnvironment	0..*	Provides the substance hazardous environment information.
Association		PackagingWeightOptimisation	0..1	Provides the packaging weight optimisation information.
Association		PackagingRenewableContent	0..*	Provides the renewable content information
attribute	packagingLevelTypeCode	PackagingLevelTypeCode	0..1	Provides the packaging level.
attribute	packagingComponentDescription	Description 80	0..*	Part of packaging that can be separated by hand or by using simple physical means (EN 13427, ISO/DIS 18601), for example a packaging film.
attribute	packagingGeneratedMaterialWaste	Measurement	0..1	The mass of material waste generated during the production and transport of packaging materials, packaging constituents, packaging components or packaging systems destined to final disposal, i.e. landfill or incineration without heat recovery.
attribute	packagingMaterialTypeCode	PackagingMaterialTypeCode	0..1	A code that provides the packaging material.
attribute	packagingMaterialDescription	Description 80	0..*	A description of the packaging material.
Association	avpList	GS1_AttributeValuePairList	0..1	Attribute value pair information.

content	attribute / role	datatype /secondary class	multiplicity	definition
LifeCycleIndicators				Provides the environmental indicator information.
Association		GlobalWarmingPotential	0..*	Provides the global warming potential information.
Association		AcidificationPotential	0..1	Provides the acidification potential information.
Association		AquaticEutrophication	0..1	Provides the aquatic eutrophication information.
Association		MassEquivalent	0..*	Provides the mass equivalent information.
Association		ToxicityProperties	0..*	Provides the toxicity properties information.
Association		FreshWaterEcotoxicityPotential	0..1	Provides the freshwater ecotoxicity potential information.
Association		CumulativeEnergyDemand	0..*	Provides the cumulative energy demand information.
Association	avpList	GS1_AttributeValuePairList	0..1	Attribute value pair information.
MassEquivalent				Provides the mass equivalent information.
attribute	massEquivalentMeasurement	Quantity	0..1	The measurement for the mass equivalent code.
attribute	massEquivalentCode	MassEquivalentCode	0..1	The type of mass equivalent being measured.
attribute	massEquivalentProtocolCode	MassEquivalentProtocolCode	0..1	The protocol code related to the mass equivalent code. Based On MassEquivalentCode, use one of following: <ul style="list-style-type: none"> • Mass Equivalent Fresh Water Consumption Protocol Code • Mass Equivalent Ionizing Radiation Human Protocol Code • Mass Equivalent Land Use Protocol Code • Mass Equivalent Nonrenewable Resource Depletion Protocol Code • Mass Equivalent Ozone Depletion Protocol Code • Mass Equivalent Particulate Respiratory Effects Protocol Code • Mass Equivalent Photochemical Ozone Creation Potential Protocol Code.
attribute	massEquivalentProtocolDescription	Description80	0..*	The protocol description related to the mass equivalent code.

content	attribute / role	datatype /secondary class	multiplicity	definition
attribute	massEquivalentSubstanceCodeReference	Code	0..1	The substance code related to the mass equivalent code. Based On MassEquivalentCode, use one of following: <ul style="list-style-type: none"> • Mass Equivalent Fresh Water Consumption Substance Code • Mass Equivalent Ionizing Radiation Human Substance Code • Mass Equivalent Land Use Substance Code • Mass Equivalent Non Renewable Resource Depletion Substance Code • Mass Equivalent Ozone Depletion Reference Substance Code • Mass Equivalent Particulate Respiratory Effects Reference Substance Code.
attribute	massEquivalentSubstanceDescription	Description 80	0..*	The substance description related to the mass equivalent code
PackagingChainOfCustody				Provides the packaging chain of custody information.
attribute	packagingChainOfCustodyEventSequenceNumber	nonNegativeInteger	0..1	The linked set of organizations, from point of harvest or extraction to point of purchase, that have held legal ownership or physical control of raw materials or recycled materials, used in packaging constituents, packaging components, or packaging systems.
attribute	packagingChainOfCustodySourceCertifiedCode	PackagingChainOfCustodySourceCertifiedCode	0..1	A code that determines whether the source has been certified.
attribute	sourceCertificationSystemProtocolCode	SourceCertificationSystemProtocolCode	0..1	Provides the organisation(s) identification that certifies the source. (e.g. Forest Stewardship Council, Sustainable Forestry Initiative, Programme for Endorsement of Forest Certification.)
attribute	sourceCertificationSystemProtocolDescription	Description 80	0..*	Provides the organisation(s) identification that certifies the source. (e.g. Forest Stewardship Council, Sustainable Forestry Initiative, Programme for Endorsement of Forest Certification.)
PackagingConstituent				Provides the packaging constituent information.
Association		PackagingSubstanceHazardousEnvironment	0..*	Provides the substance hazardous environment information.
Association		PackagingChainOfCustody	0..*	Provides the chain of custody information.
Association		PackagingRenewableContent	0..*	Provides the renewable content information

content	attribute / role	datatype /secondary class	multiplicity	definition
Association		PackagingRecycledContent	0..*	Provides the recycled content information.
Association		PackagingFacilitiesInStressedWater	0..*	Provides the facilities in stress water information.
Association		PackagingWeightOptimisation	0..1	Provides the packaging weight optimisation information.
attribute	packagingConstituent	Description80	0..*	Provides the packaging constituent
attribute	packagingGeneratedMaterialWaste	Measurement	0..1	The mass of material waste generated during the production and transport of packaging materials, packaging constituents, packaging components or packaging systems destined to final disposal, i.e. landfill or incineration without heat recovery
attribute	packagingMaterialTypeCode	PackagingMaterialTypeCode	0..1	A code that provides the packaging material.
attribute	packagingMaterialDescription	Description80	0..*	A description of the packaging material.
PackagingEconomicCost				Provides the packaging economic cost information.
attribute	totalPackagingEconomicCostAmountBasis	Measurement	0..1	The basis amount or quantity used to determine the packaging costs for example 1 kg, 1000 units, 1 year
attribute	totalPackagingEconomicCostMeasurementCode	TotalPackagingEconomicCostMeasurementCode	0..1	A code determining the packaging component, material, etc that is cost and being determined for.
attribute	totalPackagingEconomicCostMeasurementDescription	Description80	0..*	A description determining the packaging component, material, etc that is cost and being determined for.
attribute	totalPackagingEconomicCostAmount	Amount	0..*	The total cost of all materials, energy, equipment and direct labour used during the sourcing of raw, recycled and reused materials and the production, filling, transport and/or disposal of packaging materials, packaging components or units of packaging.
PackagingFacilitiesInStressedWater				Provides the ability to communicate information about production sites located in areas with conditions of water stress or scarcity.
attribute	facilitiesInStressedWaterAreaPercent	float	0..1	Percent of facilities owned by a single operator located in an area identified as a stressed or scarce water resource area.
attribute	facilitiesInStressedWaterAreaCalculationMethod	Description200	0..*	The approach or tool used to determine water stress or scarcity should be identified (e.g. Global Water Tool, ETH Water Scarcity Index).

content	attribute / role	datatype /secondary class	multiplicity	definition
attribute	numberOfFacilitiesInStressedWaterArea	nonNegativeInteger	0..1	The number of facilities involved with the production of packaging materials (including recycled materials), packaging constituents, packaging components or units of packaging and/or filling and sealing of units of packaging that operate in areas identified as stressed or scarce fresh water resource area.
PackagingRecovery				Provides the packaging recovery information.
attribute	doesPackagingRecoveryRateTypeCodeMeetTheStandard	NonBinaryLogicEnumeration	0..1	Determine if the packaging recovery rate meet the standard.
attribute	packagingRecoveryRate	float	0..1	The mass fraction or absolute mass of packaging recovered from all sources (commercial and residential) based on relevant waste management statistics.
attribute	packagingRecoveryRateDescription	Description80	0..*	The description of the recovery applicable to the packaging.
attribute	packagingRecoveryRateTypeCode	PackagingRecoveryRateTypeCode	0..1	A code determining the type of recovery applicable to the packaging.
attribute	totalPackagingRecoveryRate	float	0..1	Expressed as cumulative sum of recovery rate by recovery method in % of total packaging weight [% wt.] placed on the market or as mass expressed by rate × total packaging weight put on the market.
PackagingRecycledContent				Provides the recycled content information
attribute	packagingRecycledContentRatio	float	0..1	The ratio of recycled material to total material used in packaging constituents, packaging components, or packaging systems
attribute	packagingRecycledContentTypeCode	PackagingRecycledContentTypeCode	0..1	The type of recycled content that is being measured for.
attribute	packagingRecycledContentDescription	Description80	0..*	The description of recycled content that is being measured for.
PackagingRenewableContent				Provides the packaging renewable content information.
attribute	packagingRenewableContentRatio	float	0..1	The ratio of renewable material used to total material used in packaging constituents, components, units of packaging or packaging systems.
attribute	packagingRenewableContentTypeCode	PackagingRenewableContentTypeCode	0..1	The type of renewable content that is being measured for.
attribute	packagingRenewableContentDescription	Description80	0..*	The description of renewable content that is being measured for.
PackagingReuse				Provides the packaging reuse information.

content	attribute / role	datatype /secondary class	multiplicity	definition
attribute	numberOfCyclesPriorToWithdrawal	nonNegativeInteger	0..1	Determines reusability in accordance with EN 13429 or ISO/DIS18603.
attribute	packagingReuseRate	float	0..1	The number of times packaging accomplishes the same use, rotation or trip for which it was conceived and designed within its life cycle. Demonstration of reusability must first be established in accordance with EN 13429 or ISO/DIS18603 once final.
attribute	packagingReusabilityStandardCode	PackagingReusabilityStandardCode	0..1	The reusability standard used to determine packaging reuse rate.
attribute	packagingReusabilityStandardDescription	Description80	0..*	The description for the reusability standard used to determine packaging reuse rate.
PackagingSubstanceHazardousEnvironment				Provides the packaging substance hazardous environment information.
attribute	haveYouMinimizedHazardousSubstance	NonBinaryLogicEnumeration	0..1	Meeting the requirements of EN 13428 or ISO 18602 on heavy metals and dangerous/hazardous substances.
attribute	hazardousSubstancesMinimizationCode	HazardousSubstancesMinimizationCode	0..1	Assessment and minimization of substances, or mixtures, hazardous to the environment in packaging constituents, components, or systems that are at risk of entering the environment.
attribute	relevantSupportingSubstanceHazardousDocumentation	Description200	0..*	This is a certificate of compliance with relevant legislation. So the metric is a simple yes qualified with supporting documentation or a no.
PackagingSustainabilityEconomicIndicators				Provides the packaging sustainability economic indicator information.
Association		PackagingEconomicCost	0..*	Provides the packaging economic cost information
attribute	communityInvestmentRatio	float	0..1	The value of investments made in community projects related to packaging such as recycling education programs or recycling infrastructure development over and above regulated requirements.
attribute	packagedUnpackagedShelfLifeRatio	float	0..1	The ratio of a product's shelf life in packaging to a product's shelf life without packaging.
attribute	packagedProductWastagePercent	float	0..1	Cost of wasted goods expressed as a percentage of cost of goods sold per annum.
Association	avpList	GS1_AttributeValuePairList	0..1	Attribute value pair information.
PackagingSustainabilityModule				Provides the packaging sustainability module information

content	attribute / role	datatype /secondary class	multiplicity	definition
Association		IndividualPackagingComponentLevel	0..*	Provides the packaging level details.
Association		LifeCycleIndicators	0..1	Provides the life cycle indicator information.
Association		PackagingSustainabilityEconomicIndicators	0..1	Provides the packaging sustainability economic information
attribute	functionalBasisUnitCode	FunctionalBasisUnitCode	0..1	Code of the functional basis unit.
attribute	functionalBasisUnitDescription	Description80	0..*	Description of the functional basis unit.
attribute	packagingCubeUtilisationRatio	float	0..1	The overall volumetric measurement of packaging design efficiency. Expressed as the total volume of product in a pallet or other transport unit divided by either the volume of the transport unit or the space allotted to the transport unit, whichever is greater.
attribute	packagingToTradeItemWeightRatio	float	0..1	The ratio of the weight of all packaging material used to the weight of the product or functional unit delivered. The weight of all packaging components used in the packaging system per functional unit (i.e. per consumer use as expressed by e.g. per serving for food & beverages, per washing cycle for detergent).
attribute	packagingWeightPerConsumerUse	Measurement	0..*	The weight of all packaging components used in the packaging system per consumer use.
attribute	quantityOfFunctionalBasisUnit	Quantity	0..1	Quantity of the functional basis unit.
Association	avpList	GS1_AttributeValuePairList	0..1	Attribute value pair information.
PackagingWeightOptimisation				Provides the packaging weight optimisation details.
Association		PackagingWeightReduction	0..1	Provides the packaging weight reduction information.
attribute	packagingWeight	Measurement	0..1	The weight and identity of a packaging constituent, component or system which changes hands in the supply chain.
attribute	proofOfOptimizedPackagingWeightStandardCode	ProofOfOptimizedPackagingWeightStandardCode	0..1	The demonstration that the packaging has been minimized by weight or volume in accordance with EN 13428 or ISO/DIS 18602.

content	attribute / role	datatype /secondary class	multiplicity	definition
attribute	proofOfOptimizedPackagingWeightStandardDescription	Description 80	0..*	The description for the proof of adequate packaging weight
PackagingWeightReduction				Provides the packaging weight reduction information.
attribute	packagingWeightReduction	Measurement	0..1	The reduction of packaging weight with regards to a previous reference state expressed as a percentage reduction or an absolute weight reduction [e.g. g or kg / packaging constituent, component or system].
attribute	packagingWeightReductionProtocolName	Description 80	0..*	The protocol name that the calculation is based on (i.e. packaging weight reduction should be calculated according to the protocol stipulated in GPPS 2.0).
attribute	proofOfPackagingWeightReductionStandardCode	ProofOfPackagingWeightReductionStandardCode	0..1	The standard for the proof of packaging weight reduction is based on.
attribute	proofOfPackagingWeightReductionDescription	Description 80	0..*	The description for the proof of packaging weight reduction is based on.
attribute	previousPackagingWeight	Measurement	0..1	The packaging weight of the previous product used to calculate the packaging weight reduction.
ToxicityProperties				Provides the toxicity properties information.
attribute	hasCancerousProperties	NonBinaryLogicEnumeration	0..1	The Toxicity, Cancer indicator evaluates potential cancer-related health outcomes that may occur due to the emissions associated with a given product or process.
attribute	toxicityMeasurement	Measurement	0..1	The amount of the cancerous substance per functional unit
attribute	toxicityReferenceSubstanceCode	ToxicityReferenceSubstanceCode	0..1	The reference substance or unit which is used to represent cancerous toxicity effects.
attribute	toxicityReferenceSubstanceDescription	Description 80	0..*	The reference substance description or unit which is used to represent cancerous toxicity effects.
attribute	toxicityMeasurementProtocolCode	ToxicityMeasurementProtocolCode	0..1	The protocol code used for the measurement.
attribute	toxicityMeasurementProtocolDescription	Description 80	0..*	The description of the protocol used for the measurement.

5.45 Pharmaceutical Item Information Module

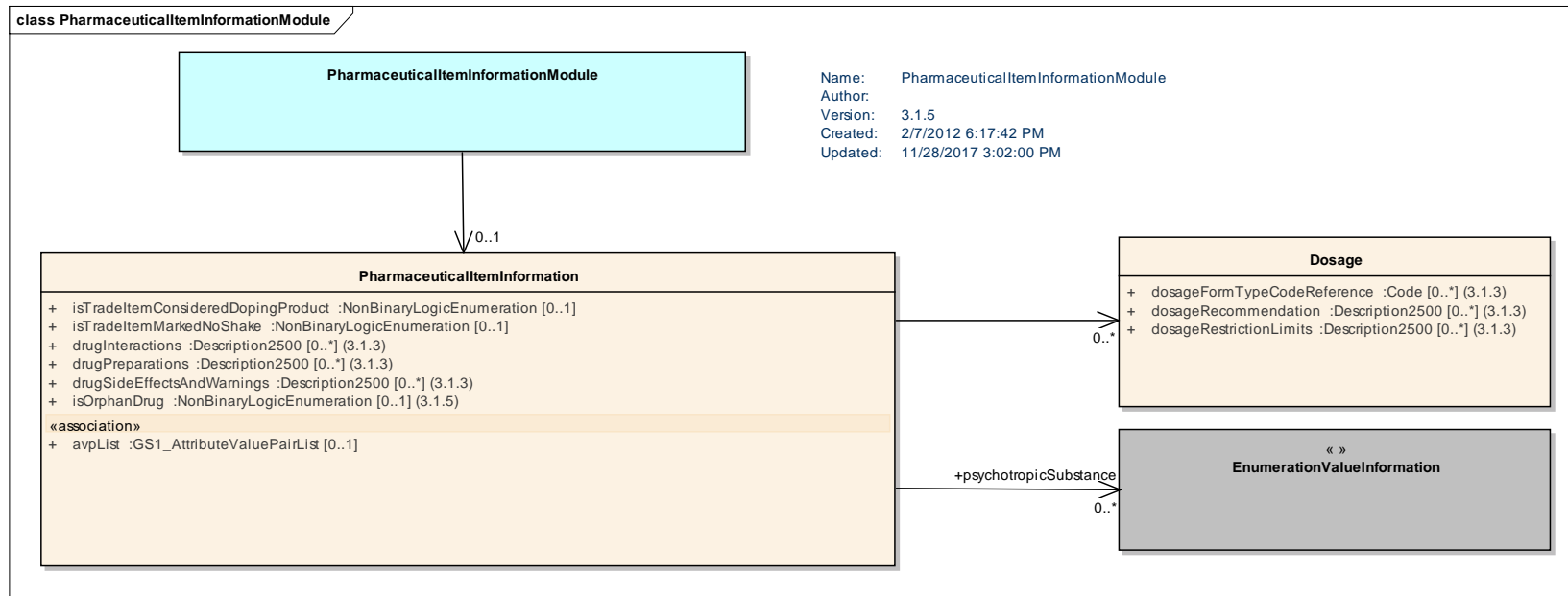

Note: Note: Common class (in grey) is located in the GDSN Common Library.

content	attribute / role	datatype /secondary class	multiplicity	definition
Dosage				Information on dosage for a pharmaceutical item.
Attribute	dosageFormTypeCodeReference	Code	0..*	A dosage form is the physical form of a medication that identifies the form of the pharmaceutical item for example oral. This attribute is populated by Local Code Lists and code lists for target market can be found on the GDSN Standards web site.
Attribute	dosageRecommendation	Description2500	0..*	Information pertaining to the dosage of drug or supplement that should be taken/administered per dose. This is not based upon prescribed dosage, but recommended dosage. This may be pre-labelled on product or need to be labelled per target market regulations. Example Take 2 tablets every 4 hours, Take 1 teaspoon daily, etc.

content	attribute / role	datatype /secondary class	multiplicity	definition
Attribute	dosageRestrictionLimits	Description2500	0..*	Information pertaining to the dosage of drug or supplement that should be taken/administered in a limited quantity. This is not based upon prescribed dosage, but recommended restrictions. This may be pre-labelled on product or need to be labeled per target market regulations. Example Do not exceed no more than 8 tablets per day, Do not exceed use for more than 14 days, etc.
PharmaceuticalItem Information				Information on medicinal drugs.
Association	psychotropicSubstance	ExternalCodeValueInformation	0..*	A psychotropic substance is any chemical agent affecting the mind or mental processes (i.e., any psychoACTIVE drug). (ii) In the context of international drug control, 'psychotropic substance' means any substance, natural or synthetic, or any natural material in Schedule I, II, III or IV of the 1971 Convention. *Those utilizing this functionality should be aware of the Vienna convention and requirement to annually declare stock movements to national control body.Examples of psychoactive drugs may include: amphetamines, barbiturates, and psychedelics. This class of substances includes almost any conceivable mind-altering substance.
Association		Dosage	0..*	Information on dosage for a pharmaceutical item.
Association	avpList	GS1_AttributeValuePairList	0..1	The transmission of non-standard data done in a simple, flexible, and easy to use method.
Attribute	isOrphanDrug	NonBinaryLogicEnumeration	0..1	Indicates whether or not the pharmaceutical product is an orphan drug. A pharmaceutical is said to be an orphan when it has been developed to cure rare diseases also called orphan disease.
Attribute	isTradeItemConsideredDopingProduct	NonBinaryLogicEnumeration	0..1	Indicates that the product could be considered a doping substance which is a substance which is part of the list of prohibited substances, pharmaceutical products and methods yearly published by World Anti-Doping Agency. Doping products typically fall into one of the following general types of substances: Anabolic Agents, Hormones and Related Substances, Beta-2 Agonist, Hormone Antagonist and Modulators, Diuretics and other Masking Agents, Stimulants, Narcotics, Cannabinoids, Glucocorticosteroids, Alcohol, Beta-Blockers.
Attribute	isTradeItemMarkedNoShake	NonBinaryLogicEnumeration	0..1	Indicates that the trade item is marked to not be shaken during transport, storage, or use.

content	attribute / role	datatype /secondary class	multiplicity	definition
Attribute	drugInteractions	Description2500	0..*	Pertaining to different type of consumer information needed for proper usage of drug or supplement. This may be pre-labeled on product or need to be labeled per target market regulations. Examples include Do not take with alcohol, Eat with food, Do not take if you are on diabetic medication, etc.
Attribute	drugPreparations	Description2500	0..*	Instructions for the consumer in preparing the drug or supplement before usage. This may be pre-labeled on product or need to be labeled per target market regulations. Examples include Shake before using, Add to 200 millitres of water, etc.
Attribute	drugSideEffectsAndWarnings	Description2500	0..*	Information to the side effects of the drug or supplement. This may be pre-labeled on the product or need to be labeled per target market regulations. Examples include Could make you drowsy, Do not operate machinery, Do not take if you are pregnant, etc.
PharmaceuticalItem InformationModule				A module containing information on medicinal drugs.
Association		PharmaceuticalItemInformation	0..1	Pharmaceutical information for a trade item.

5.46 Physical Resource Usage Information Module

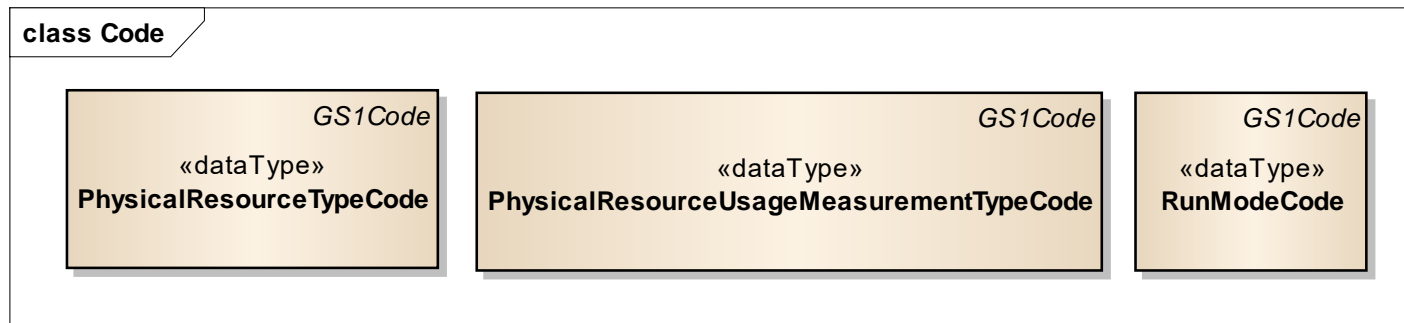
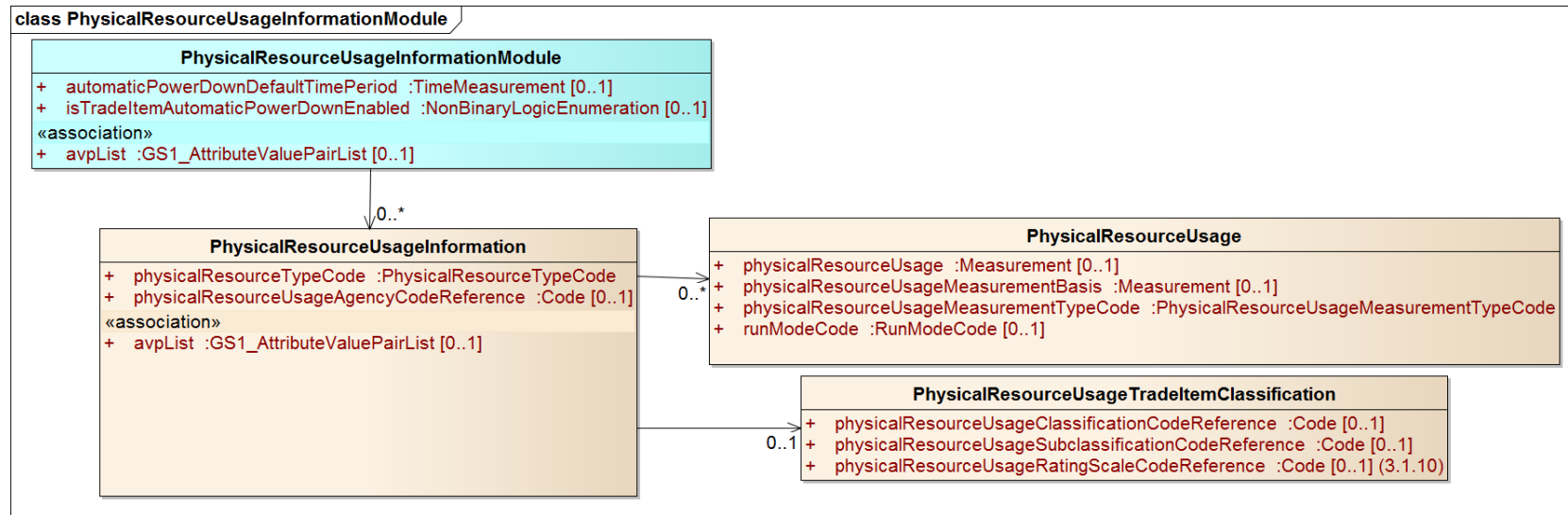

content	attribute / role	datatype /secondary class	multiplicity	definition
PhysicalResource Usage				Information on the amount of resources used of generated by a device.
Attribute	physicalResourceUsageMeasurementTypeCode	PhysicalResourceUsageMeasurementTypeCode	1..1	A qualifier determining whether the resource usage is maximum, average, minimum, etc.
Attribute	physicalResourceUsageMeasurementBasis	Measurement	0..1	The basis used to determine the resource usage for the trade item for example time period (e.g. hours, days, years).
Attribute	physicalResourceUsage	Measurement	0..1	The amount of resources used or generated by a device.
Attribute	runModeCode	runModeCode	0..1	The functional mode of a device expressed as a code for example ON, SLEEP or STANDBY. Run modes are defined by various guidelines for example the energy star guideline.
PhysicalResource UsageTradeItemClassification				A trade item classification used to drive requirements for information for trade items which use physical resources for example water or electricity.
Attribute	physicalResourceUsageSubclassificationCodeReference	Code	0..1	A sub-classification code value from a product classification scheme provided to drive required information for resource usage.
Attribute	physicalResourceUsageClassificationCodeReference	Code	0..1	A classification code value from a product classification scheme provided to drive required information for resource usage.
Attribute	physicalResourceUsageRatingScaleCodeReference	Code	0..1	The value in a range or scale of efficiency of the product is rated, for example, spectrum A – G.
PhysicalResource UsageInformation				Details on the usage of physical resources for a trade item during various modes of usage.
Association		PhysicalResourceUsageTradeItemClassification	0..1	A trade item classification used to drive requirements for information for trade items which use physical resources.
Association		PhysicalResourceUsage	0..*	Information on the amount of physical resources used and/or energy output for a trade item.
Association	avpList	GS1_AttributeValuePairList	0..1	The transmission of non-standard data done in a simple, flexible, and easy to use method.
Attribute	physicalResourceTypeCode	physicalResourceTypeCode	1..1	A code depicting the type of physical resource being measured for usage for example electricity, gas.
Attribute	physicalResourceUsageAgencyCodeReference	Code	0..*	The agency that regulates resource usage for products within a target market. For example Environmental Protection Agency (EPA) in the United States.

content	attribute / role	datatype /secondary class	multiplicity	definition
PhysicalResourceUsageInformationModule				A module containing details on the usage of resources and/or energy output for a trade item during various modes of usage.
Association		PhysicalResourceUsageInformation	0..*	Details on the usage of resources for a trade item during various modes of usage.
Association	avpList	GS1_AttributeValuePairList	0..1	The transmission of non-standard data done in a simple, flexible, and easy to use method.
Attribute	automaticPowerDownDefaultTimePeriod	TimeMeasurement	0..1	The default time value that the product will automatically power down for trade item.
Attribute	isTradeItemAutomaticPowerDownEnabled	NonBinaryLogicEnumeration	0..1	An indicator whether a product is enabled with auto power down feature when shipped to the customer. Auto power down is a feature that operates similarly to power management features and requires the unit to enter a standby passive mode after a certain pre-set number of hours of user inactivity.

5.47 Place of Item Activity Module

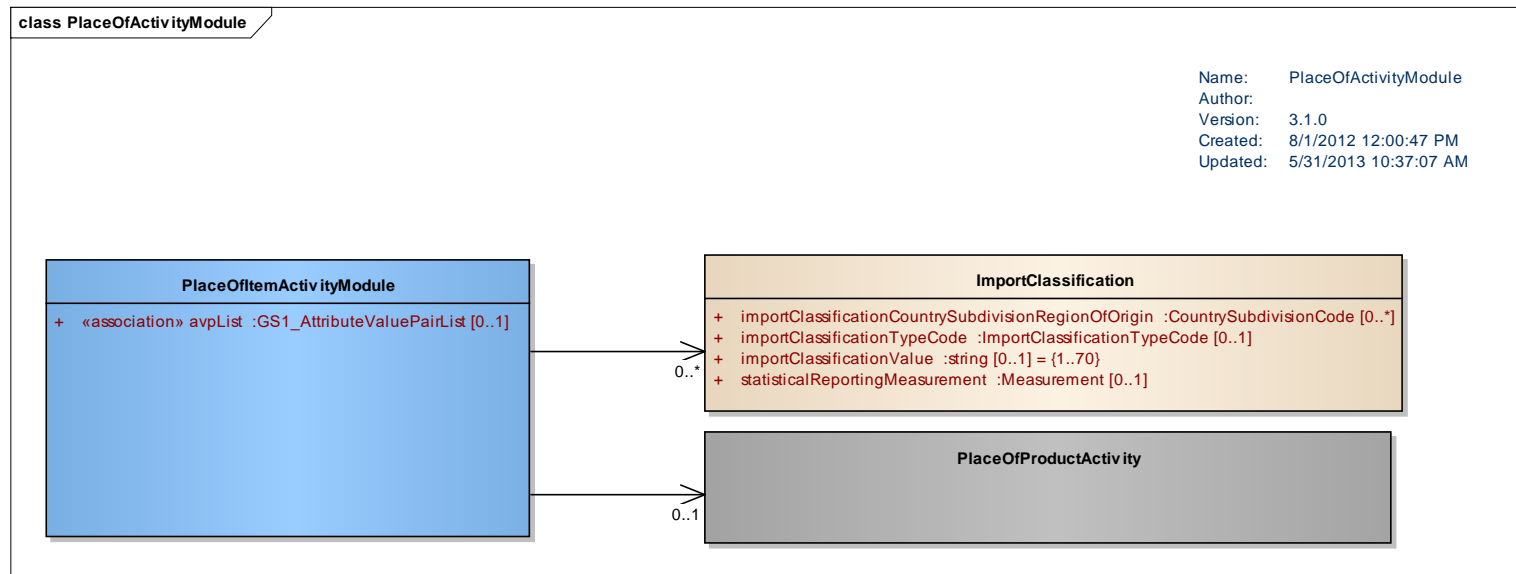

 **Note:** Common class (in grey) is located in the GDSN Common Library.

content	attribute / role	datatype /secondary class	multipl icity	definition
ImportClassificati on				Imports and exports of trade items typically require classification codes to determine appropriate duties and tariffs. Values include Netherlands Import Code, Harmonized Commodity Description and Coding System, Customs Tariff and INTRASTAT Code, Harmonized Tariff Schedule of the United States, INTRASTAT Combined Nomenclature, Tarif Intégré de la Communauté
Attribute	importClassificati onCountrySubdivi sionRegionOfOrigin	CountrySubdivi sionCode	0..*	The region of origin of the trade item for import purposes. This is required by Intrastat.
Attribute	importClassificati onTypeCode	ImportClassifica tionTypeCode	0..1	Imports and exports of trade items typically require classification codes to determine appropriate duties and tariffs. Values include Netherlands Import Code, Harmonized Commodity Description and Coding System, Customs Tariff and INTRASTAT Code, Harmonized Tariff Schedule of the United States, INTRASTAT Combined Nomenclature, Tarif Intégré de la Communauté
Attribute	importClassificati onValue	string	0..1	The value for an associated import classification type.
Attribute	statisticalReportin gMeasurement	Measurement	0..1	The amount of the trade item net of any packaging (e.g. Box, Spool) provided for statistical reporting purposes. In the EU, the Supplementary Unit of the Intrastat Supplementary Declaration, provided when the Net Mass in Kilograms is not acceptable based on the Commodity Classification for Foreign Trade Statistics. For example, ice cream is reported in net mass so no supplementary unit is required. Carpets are reported in square metres, so the area of carpet of the trade item should be shown in statistical Reporting Measurement in square metres.
PlaceOfItemAc tivityModule				Origin and other information for the purposes of customs, marketing, etc.
Association		PlaceOfProduct Activity	0..1	Information on the activity (e.g. bottling) taken place for a trade item as well as the associated geographic area.
Association		ImportClassifica tion	0..*	The value for an associated import classification type.
Association	avpList	GS1_AttributeV aluePairList	0..1	The transmission of non-standard data done in a simple, flexible, and easy to use method.

5.48 Plumbing HVAC Pipe Information Module

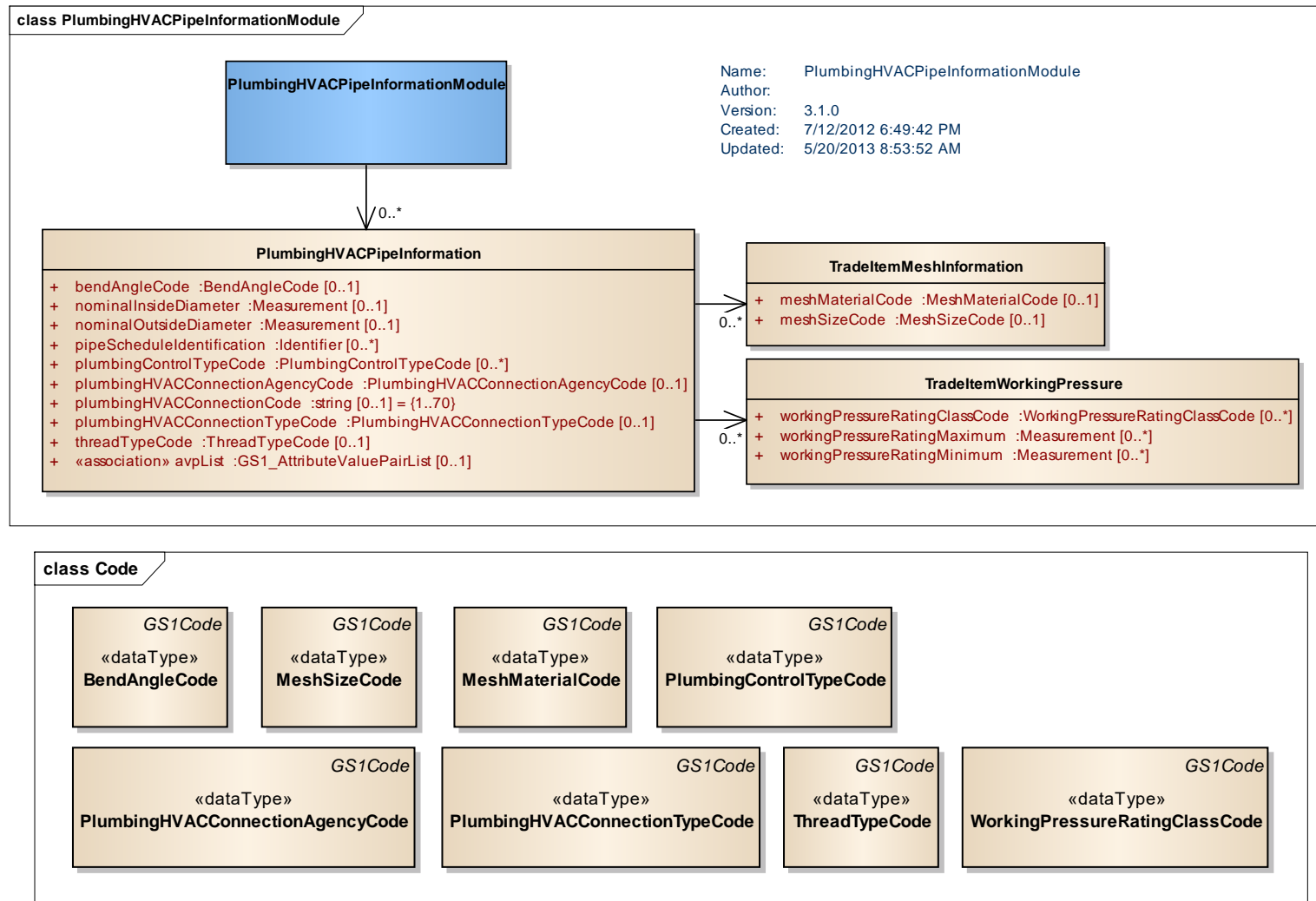

content	attribute / role	datatype /secondary class	multiplcity	definition
PlumbingHVACPipeInformation				Plumbing and HVAC information for a trade item.
Association		TradeItemMeshInformation	0..*	Information related to mesh trade items.
Association		TradeItemWorkingPressure	0..*	Information related to the working pressure of a trade item.
Association	avpList	GS1_AttributeValuePairList	0..1	Attribute value pair information.
Attribute	bendAngleCode	bendAngleCode	0..1	The type of bend or angle for the product. For example a pipe made to turn a corner might have a bend angle of 90 degrees.
Attribute	nominalInsideDiameter	Measurement	0..1	The measurement of the nominal (not the exact measurement) inside diameter of the plumbing connection point of the trade item.
Attribute	nominalOutsideDiameter	Measurement	0..1	The measurement of the nominal (not the exact measurement) outside diameter of the plumbing connection point of the trade item.
Attribute	pipeScheduleIdentification	Identifier	0..*	The pipe schedule or rating size as defined by an external agency for example Schedule 40 or SDR-9. A pipe schedule is how this is classified in regards to the functions of the pipe including type of medium (e.g. solid, liquid or gas) and pressure rating.
Attribute	plumbingControlTypeCode	PlumbingControlTypeCode	0..*	The mechanism used for the flow control of the unit for example faucet, handle, wheel, electronic actuator.
Attribute	plumbingHVACConnectionAgencyCode	PlumbingHVACConnectionAgencyCode	0..1	The agency which controls the standards used to determine the design for a plumbing HVAC connection type and dimensions.
Attribute	plumbingHVACConnectionCode	string	0..1	A code determining the connection point on the trade item that the plumbing connection type refers to. This code is determined by standards established by the plumbing HVAC connection agency.
Attribute	plumbingHVACConnectionTypeCode	PlumbingHVACConnectionTypeCode	0..1	The type of plumbing HVAC connection points available for the trade item for example grooved joint. The connection type(s) will help determine how this trade item can connect to other products.

content	attribute / role	datatype /secondary class	multipl city	definition
Attribute	threadTypeCode	ThreadTypeCode	0..1	The type of pipe threading available on the product. Threading is the grooves onto which another unit or part can be screwed to make a connection
PlumbingHVACPipeInformationModule				Pipe and heating, ventilation, and air conditioning information for a trade item.
Association		PlumbingHVACPipeInformation	0..*	Pipe and heating, ventilation, and air conditioning information for a trade item.
TradeItemMeshInformation				Information related to mesh trade items.
Attribute	meshMaterialCode	MeshMaterialCode	0..1	The material used to create the mesh strainer in the product. The mesh provides particulate filtration for the unit.
Attribute	meshSizeCode	MeshSizeCode	0..1	The size of the openings in the mesh strainer of the product as an integer. The mesh provides particulate filtration for the unit.
TradeItemWorkingPressure				Information related to the working pressure of a trade item.
Attribute	workingPressureRatingClassCode	WorkingPressureRatingClassCode	0..*	The state of the medium being pushed through the pipe for example water or steam in relation to determining working pressure.
Attribute	workingPressureRatingMaximum	Measurement	0..*	The maximum approved working pressure rating for the product for a specific medium state (water, gas, etc).
Attribute	workingPressureRatingMinimum	Measurement	0..*	The minimum approved working pressure rating for the product for a specific medium state (water, gas, etc).

5.49 Product Characteristics Module

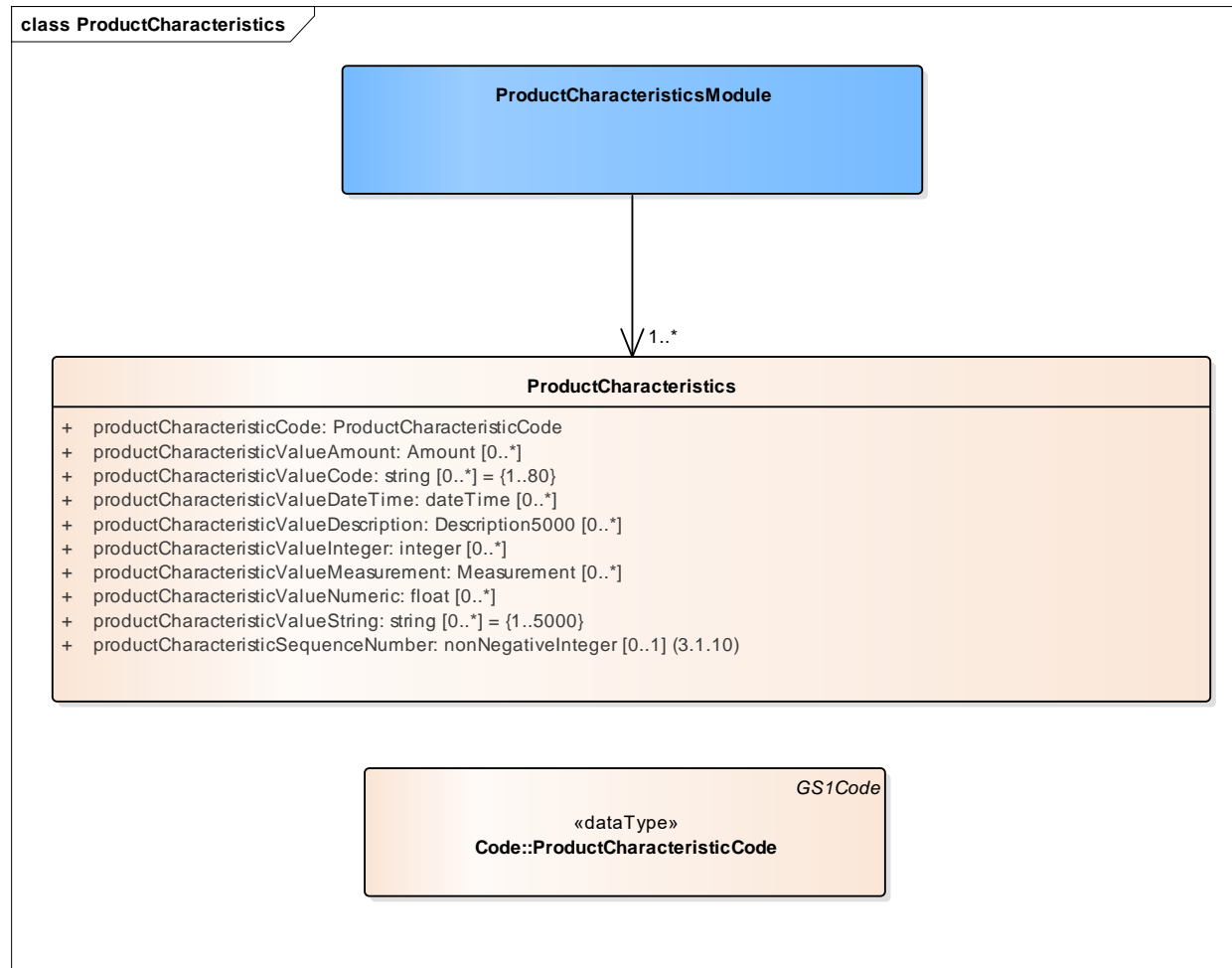

content	attribute / role	datatype /secondary class	multipl city	definition
ProductCharacteristics				A characteristic for a product for example values for a property such as numberOfPlys along with its associated value for example 2.
Attribute	productCharacteristicCode	productCharacteristicCode	1..1	The name of the product characteristic being described for example numberOfPlys.
Attribute	productCharacteristicValueAmount	Amount	0..*	The product characteristic value expressed as an amount (with currency code).
Attribute	productCharacteristicValueCode	string	0..*	The product characteristic value expressed as a code.
Attribute	productCharacteristicValueDateTime	dateTime	0..*	The product characteristic value expressed as a date and time.
Attribute	productCharacteristicValueDescription	Description5000	0..*	The product characteristic value expressed as a description (text with language).
Attribute	productCharacteristicValueInteger	integer	0..*	The product characteristic value expressed as an integer.
Attribute	productCharacteristicValueMeasurement	Measurement	0..*	The product characteristic value expressed as a measurement (float with unit of measure).
Attribute	productCharacteristicValueNumeric	float	0..*	The product characteristic value expressed as a float.
Attribute	productCharacteristicValueString	string	0..*	The product characteristic value expressed as a string (text value with no language).
Attribute	ProductCharacteristicSequenceNumber	nonNegativeInteger	0..1	A sequence number indicating the order number of the set of characteristics.
ProductCharacteristicsModule				A module used to express characteristics for a product for example values for a property such as numberOfPlys.
Association		ProductCharacteristics	1..*	The product characteristic value expressed as an amount (with currency code).

5.50 Product Formulation Statement Module

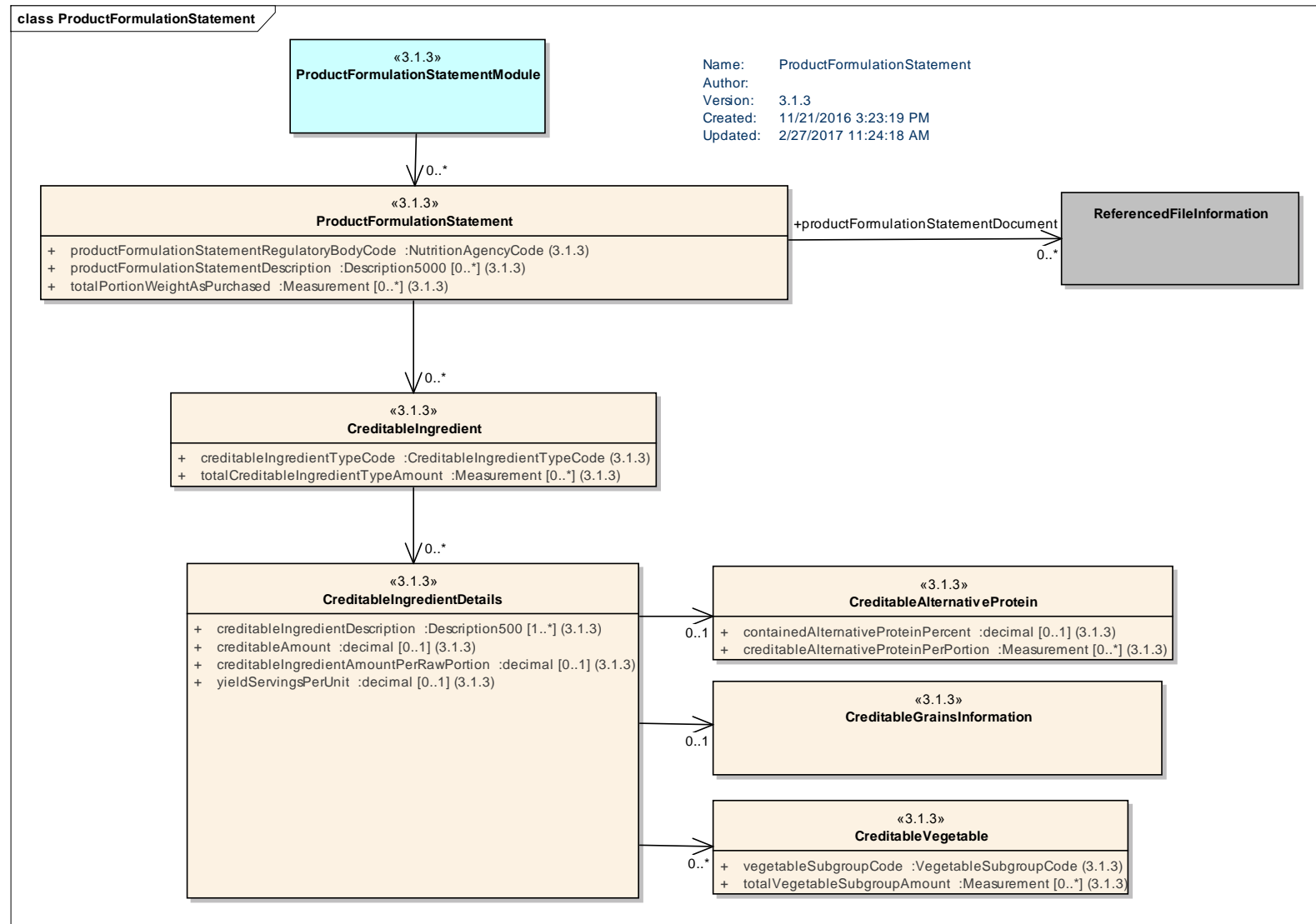

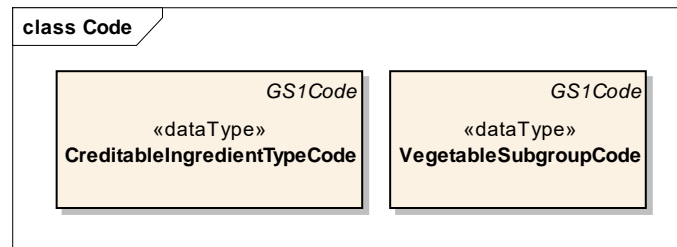
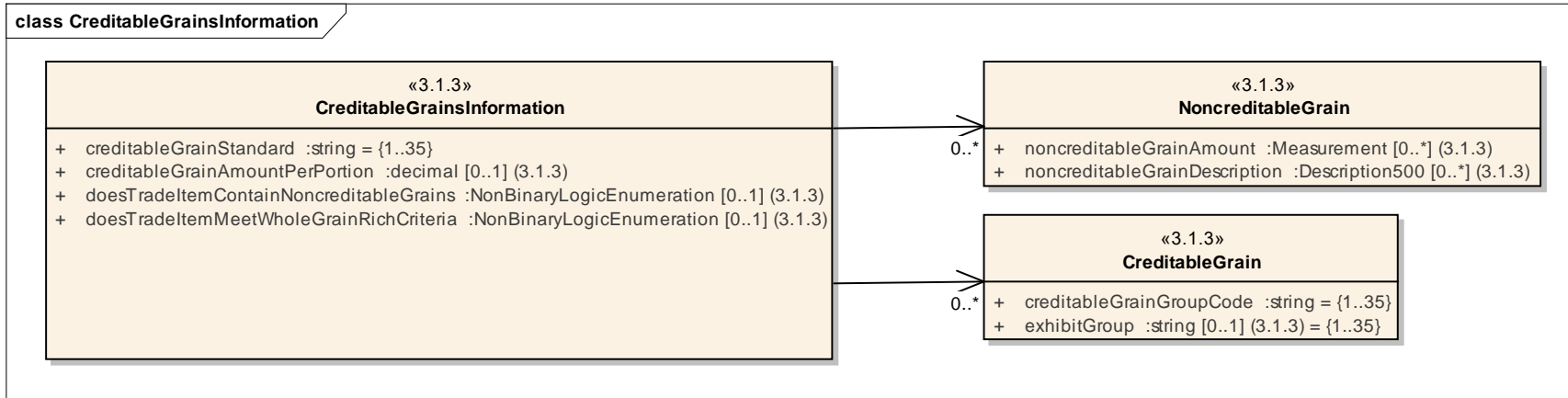

content	attribute / role	datatype /secondary class	multiplicity	definition
CreditableAlternativeProtein				A class of attributes to provide information on specific protein creditable ingredients of the item.
Attribute	containedAlternativeProteinPercent	decimal	0..1	The percent of alternative protein as provided in the item. In the US this is noted on the Alternate Protein Product (APP) documentation.
Attribute	creditableAlternativeProteinPerPortion	Measurement	0..*	The portion of alternative protein as provided in the item. In the US this is noted on the Alternate Protein Product (APP) documentation and is measured in ounces.
CreditableGrain				A class of attributes to provide information on specific grain creditable ingredients of the item .

content	attribute / role	datatype /secondary class	multiplicity	definition
attribute	creditableGrainGroup Code	string	1..1	The code assigned by the Product Formulation Statement Regulatory Body indicating to which exhibit group the trade item belongs. This code specifics set the formulas and calculations used to determine the grain equivalents for the trade item.
Attribute	exhibitGroup	string		A reference to the exhibit grouping for the creditable ingredient, described in the creditable ingredient description of the Product Formulation Statement and defined by the requirements, rules and regulations set forth by the applicable product formulation statement regulatory body.
CreditableGrainsInformation				A class of attributes to provide information on specific grain creditable and non-creditable ingredients of the item.
Association		NoncreditableGrain	0..*	A link to a class of attributes to provide information on non-creditable grains in the trade item.
Association		CreditableGrain	0..*	A link to a class of attributes to provide information on specific grain creditable ingredients of the item.
Attribute	creditableGrainStandard	string	1..1	The standard gram value applicable to the creditable grain group code.
Attribute	creditableGrainAmountPerPortion	decimal	0..1	The gram per portion value of the creditable grains contained in the trade item as specified on the Product Formulation Statement and defined by the requirements, rules and regulations set forth by the applicable product formulation statement regulatory body.
Attribute	doesTradeItemContainNoncreditableGrains	NonBinaryLogicEnumeration	0..1	An indication that the item contains non-creditable grains. The existence of non-creditable grains in excess of specified limits may alter the item's credit toward child nutrition requirements as specified by the applicable Product Formulation Statement Regulatory Body.
Attribute	doesTradeItemMeetWholeGrainRichCriteria	NonBinaryLogicEnumeration	0..1	An indication the trade item meets the whole grain-rich criteria as defined and regulated by the applicable Product Formulation Statement Regulatory Body.
CreditableIngredient				A class of attributes to provide information on the creditable ingredients of the item. Creditable ingredients are ingredients that meet a the needs of a certain diet.
Association		CreditableIngredientDetails	0..*	Provides details on creditable ingredients.
Attribute	creditableIngredientTypeCode	CreditableIngredientTypeCode	1..1	A qualifier to specify a type of creditable ingredient applicable to the trade item as noted on the Product Formulation Statement and specified by the requirements, rules and regulations set forth by the applicable Product Formulation Statement Regulatory Body.

content	attribute / role	datatype /secondary class	multiplicity	definition
Attribute	totalCreditableIngredientTypeAmount	Measurement	0..*	The sum total creditable amount of all the creditable ingredient type(s) applicable for the item as calculated using the requirements, rules and regulations set forth by the applicable Product Formulation Statement Regulatory Body. Per US regulations total creditable amount must be rounded down to the nearest quarter (0.25) ounce equivalent in the US target market.
CreditableIngredientDetails				A class of attributes providing information on individual creditable ingredients related to the creditable ingredient type.
Association		CreditableVegetable	0..*	Details for creditable vegetables.
Association		CreditableGrainsInformation	0..1	Details on creditable grain ingredients.
Association		CreditableAlternativeProtein	0..1	Provides attributes on information on specific protein creditable ingredients of the item.
Attribute	creditableIngredientDescription	Description500	1..*	A description of the trade item's creditable ingredient applicable to the creditable ingredient type and as noted on the Product Formulation Statement. In the US, this description should be from the Food Buying Guide or an Alternate Protein Product letter (APP) or a Child Nutrition Source Label.
Attribute	creditableAmount	decimal	0..1	The creditable amount of the provided creditable ingredient as listed in the Creditable Ingredient Description and calculated as specified in the requirements, rules and regulations set forth by the applicable Product Formulation Statement Regulatory Body.
Attribute	creditableIngredientAmountPerRawPortion	decimal	0..1	The ounces per portion value of the raw creditable fruit or vegetable ingredient contained in the trade item as specified on the Product Formulation Statement and defined by the requirements, rules and regulations set forth by the applicable Product Formulation Statement Regulatory Body.
Attribute	yieldServingsPerUnit	decimal	0..1	The yield per purchasing unit as calculated using the requirements, rules and regulations set forth by the applicable product formulation statement regulatory body.
CreditableVegetable				A class of attributes to provide information on specific ingredients of the item that are creditable as a vegetable.
Attribute	vegetableSubgroupCode	VegetableSubgroupCode	1..1	A qualifier to specify the type of creditable vegetable ingredient subgroup applicable to the item as specified on the Product Formulation Statement and defined by the requirements, rules and regulations set forth by the applicable product formulation statement regulatory body.
Attribute	totalVegetableSubgroupAmount	Measurement	0..*	The creditable amount of the vegetable subgroup in the item.

content	attribute / role	datatype /secondary class	multiplicity	definition
NoncreditableGrain				A class of attributes to provide information on non-creditable grains in the trade item.
Attribute	noncreditableGrainAmount	Measurement	0..*	The amount of the non-creditable grain contained in the item. Measured in grams per US regulation.
Attribute	noncreditableGrainDescription	Description500	0..*	A descriptive term to describe the non-creditable grain contained in the item. This value must be supplied when non-creditable grains are present in the trade item. In the US, this description should be from the Food Buying Guide.
ProductFormulationStatement				A class of attributes to provide information from the product formulation statement for the item.
Association		CreditableIngredient	0..*	Provides a creditable ingredients as per the product formulation statement.
Association	productFormulationStatementDocument	ReferencedFileInformation	0..*	A link to a copy of the Product Formulation Statement.
Attribute	productFormulationStatementRegulatoryBodyCode	NutritionAgencyCode	1..1	The agency within the target market which is responsible for the requirements, rules and regulations governing the product formulation statement calculations, format and contents.
Attribute	productFormulationStatementDescription	Description5000	0..*	A textual statement listed on the Product Formulation Statement as specified in the requirements, rules and regulations set forth by the applicable Product Formulation Statement Regulatory Body. The name and position of the company official who has signed the actual statement.
Attribute	totalPortionWeightAsPurchased	Measurement	0..*	The total portion weight of the trade item as purchased. This value(s) is as noted on the Product Formulation Statement and expressed in at least one measurement.
ProductFormulationStatementModule				A module used to send product formulation information for a trade item.
Association		ProductFormulationStatement	0..*	A link to a class of attributes to provide information from the product formulation statement for the item.



5.51 Product Information Module

Product Information Module is a B2C Module with attributes that are of codelist value, this module will pass attributes faster in the GDSN standard therefore, schemas for this Module will be available based upon community feedback. The classes for this module are not a directly mapped to the GPC standard.

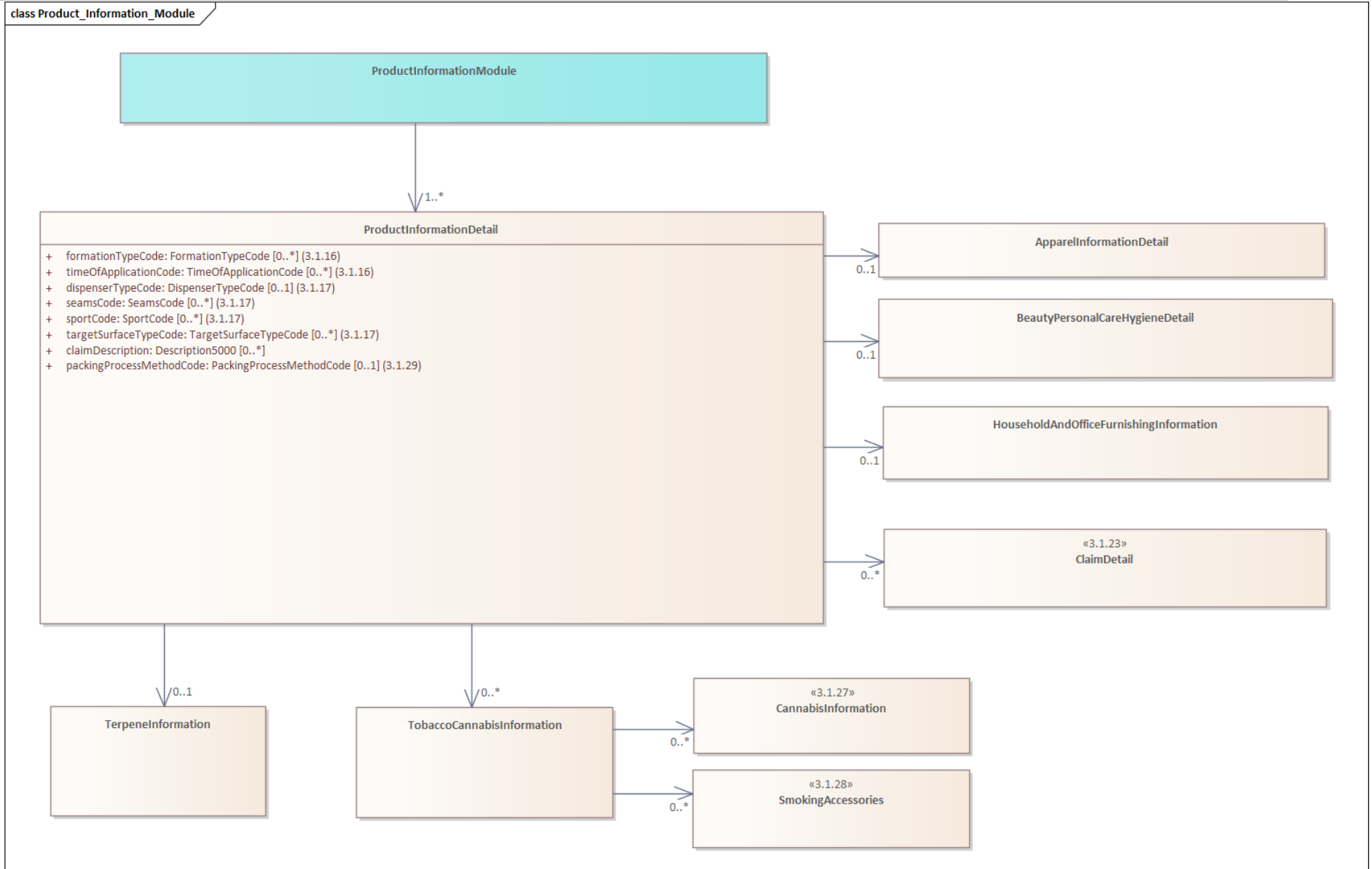

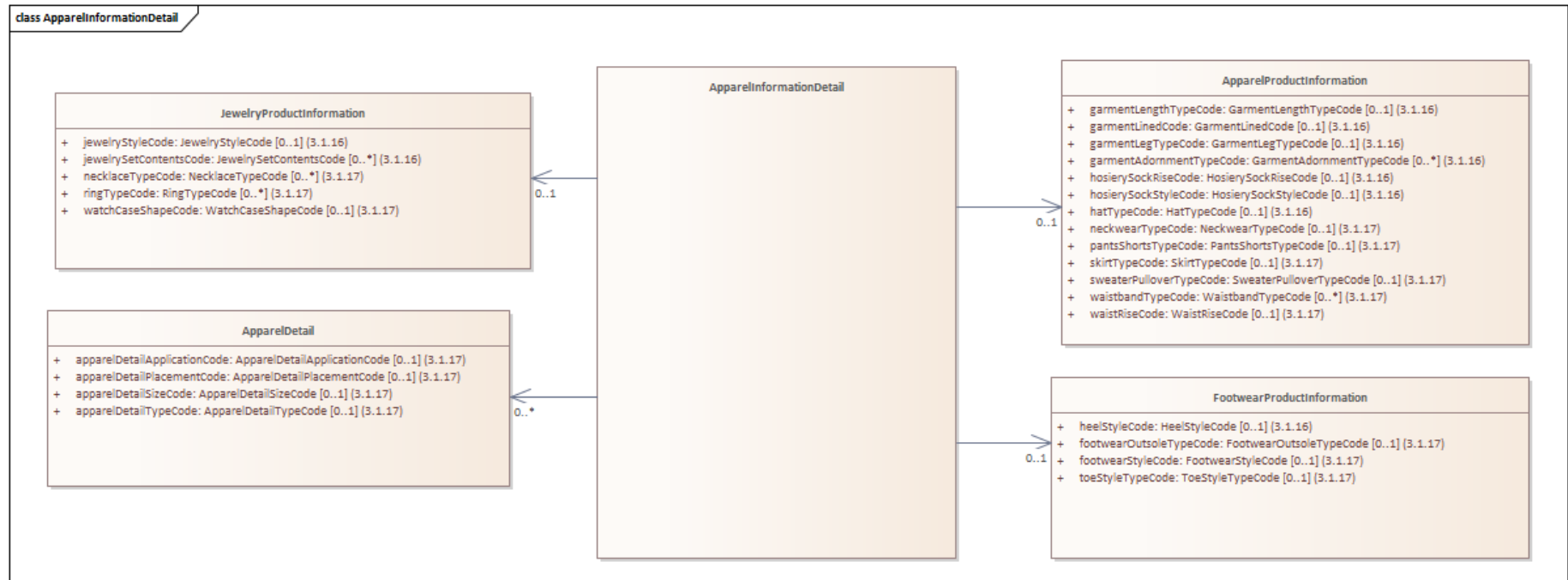

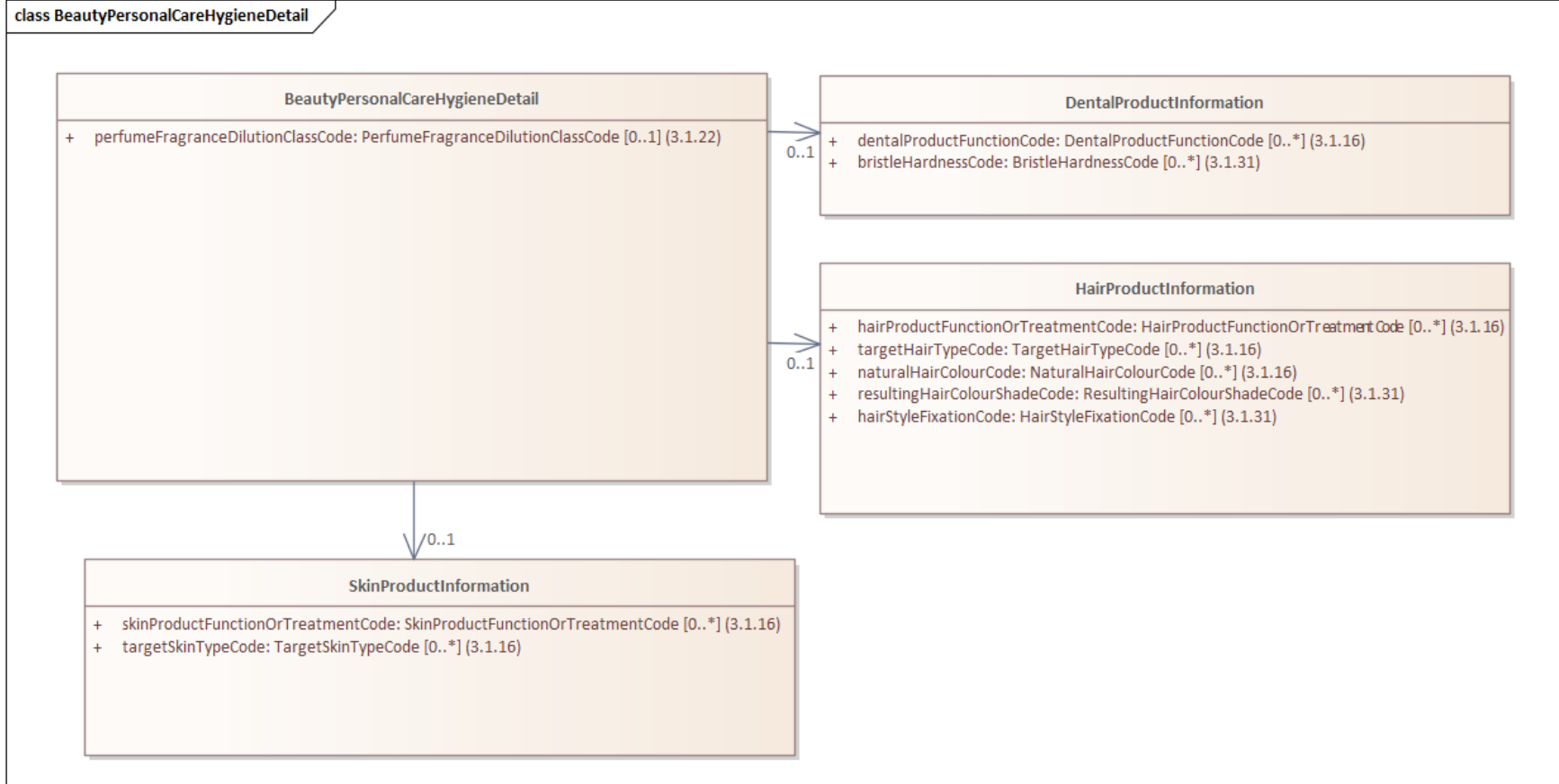

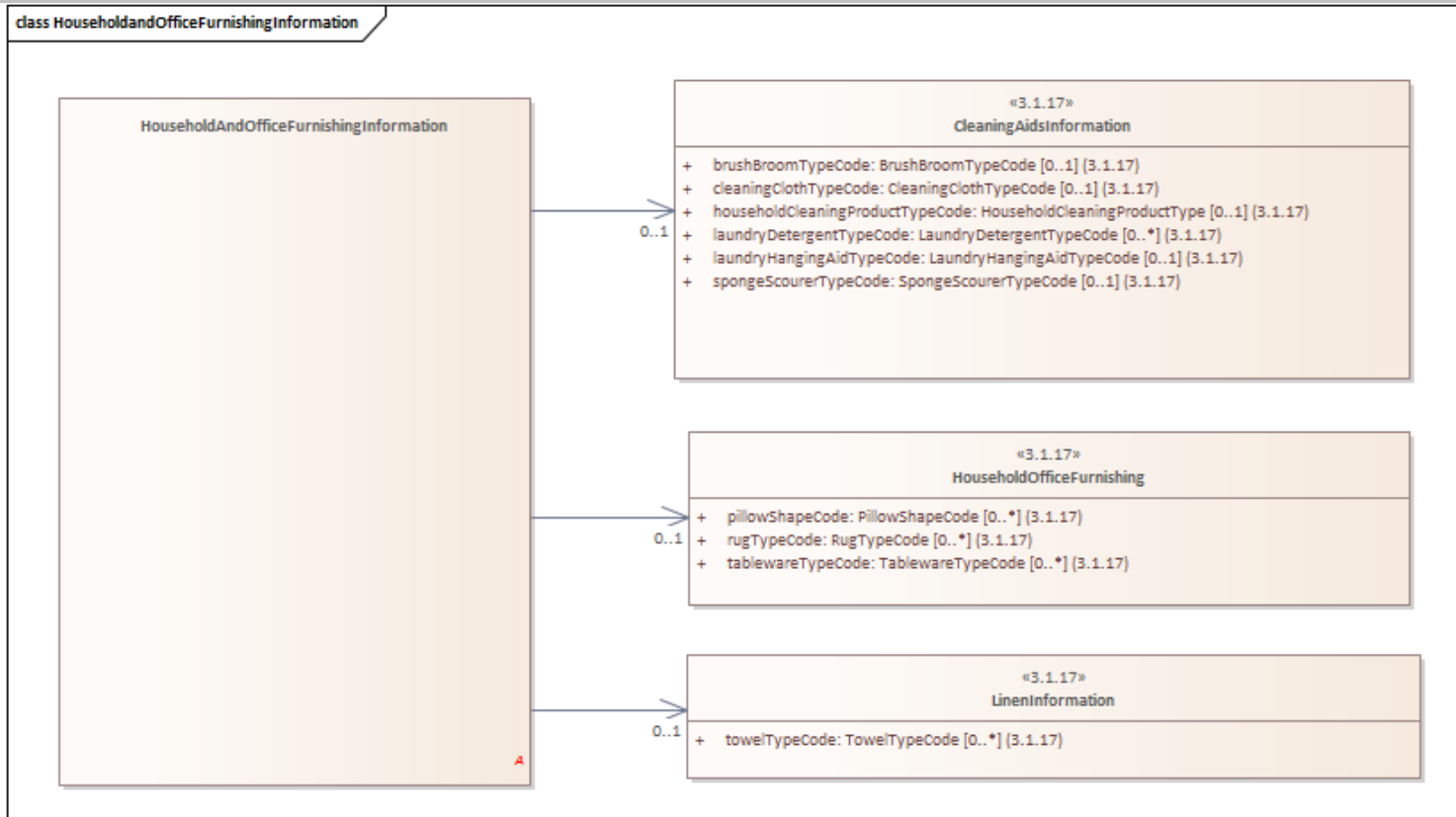

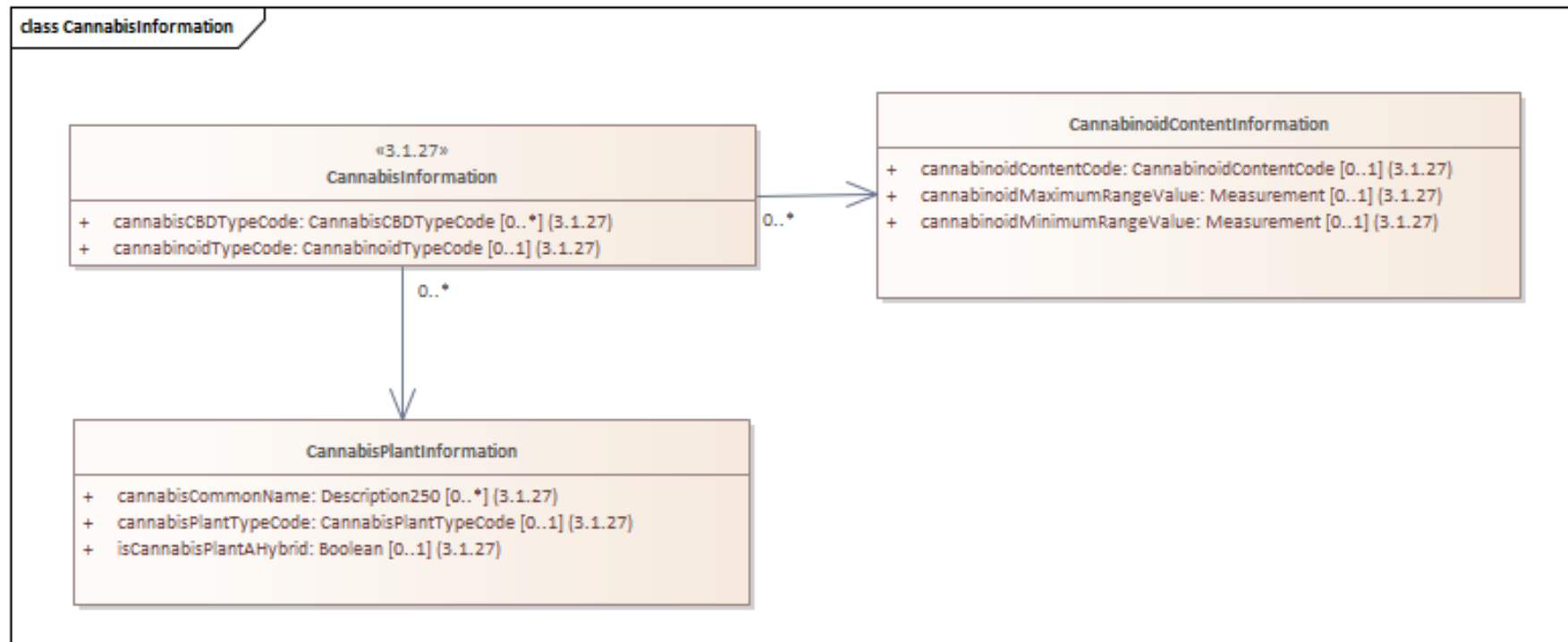
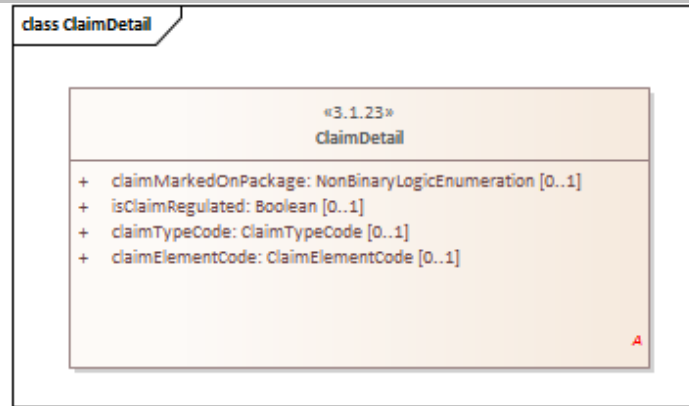

class TerpeneInformation**TerpeneInformation**

- + terpeneTypeCode: TerpeneTypeCode (3.1.27)
- + maximumTerpeneContent: Measurement [0..1] (3.1.27)
- + minimumTerpeneContent: Measurement [0..1] (3.1.27)
- + terpeneSourceCode: TerpeneSourceCode [0..1] (3.1.28)

class SmokingAccessories«3.1.28»
SmokingAccessories

- + cartridgeDeviceCompatibilityCode: CartridgeDeviceCompatibilityCode [0..1] (3.1.28)
- + vapeDeviceTypeCode: VapeDeviceTypeCode [0..1] (3.1.28)
- + vapingKitCompatibilityCode: VapingKitCompatibilityCode [0..*] (3.1.28)



ExternalAgriculturalQualityStandardCode

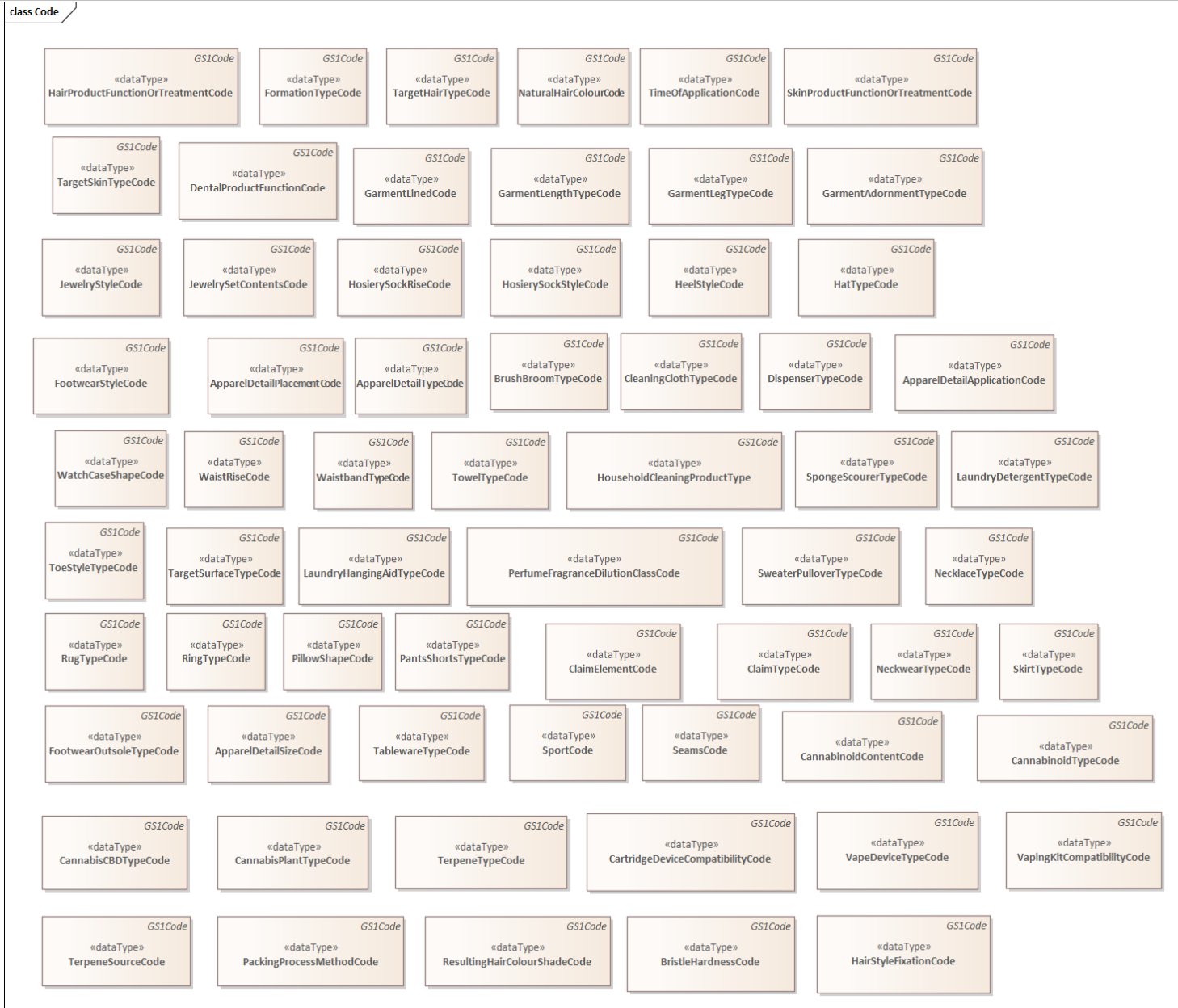

Content	attribute / role	datatype /secondary class	multiplicity	definition
ProductInformationModule				Information on Product information items for B2C attributes
ProductInformationDetail				Details specific to product trade items
Attribute	dispenserTypeCode	DispenserTypeCode	0..1	The mechanism or method by which the product is dispensed from its container.
Attribute	formationTypeCode	FormationTypeCode	0..*	Indicates, with reference to the product branding, labelling or packaging, the descriptive term that is used by the product manufacturer to identify the state in which the product is sold.
Attribute	packingProcessMethodCode	PackingProcessMethodCode	0..1	The code indicating the process used to place the product in its packaging.
Attribute	seamsCode	SeamsCode	0..*	A code indicating the characteristic of the seams of a product.
Attribute	sportCode	SportCode	0..*	A code indicating the sport associated with the product.
Attribute	targetSurfaceTypeCode	TargetSurfaceTypeCode	0..*	The surfaces a product is intended to be used upon. Some manufacturers designate one or more specific surface types from this list to help consumers understand product application.
Attribute	timeOfApplicationCode	TimeOfApplicationCode	0..*	Indicates, with reference to the product branding, labelling or packaging, the descriptive term that is used by the product manufacturer to identify the time of product application.
Attribute	claimDescription	Description5000	0..*	Free text field for any additional type of product claims like nutritional, health claims,etc.
ApparelInformationDetail				A class of attributes providing information on apparel products
ApparelDetail				A class of attributes providing information on the detail of the apparel trade item.
Attribute	apparelDetailApplicationCode	ApparelDetailApplicationCode	0..1	A code Indicating the application of the detail on a product.
Attribute	apparelDetailPlacementCode	ApparelDetailPlacementCode	0..1	A code indicating the location of the detail application on a product.

Content	attribute / role	datatype /secondary class	multiplicity	definition
Attribute	apparelDetailSizeCode	ApparelDetailSizeCode	0..1	The size of the detail application/logo.
Attribute	apparelDetailTypeCode	ApparelDetailTypeCode	0..1	The type of detail on a the apparel product.
ApparelProductInformation				Details specific to apparel trade items
Attribute	garmentLinedCode	GarmentLinedCode	0..1	A code indicating how much a garment is lined.
Attribute	garmentAdornmentTypeCode	GarmentAdornmentTypeCode	0..*	A code indicating the form of an adornment or embellishment to an item.
Attribute	garmentLegTypeCode	GarmentLegTypeCode	0..1	A code indicating the form or fit of the leg portion of a pair of pants or jeans.
Attribute	garmentLengthTypeCode	GarmentLengthTypeCode	0..1	A code indicating the length of a garment where the hem line falls on mid or lower body.
Attribute	hatTypeCode	HatTypeCode	0..1	A code indicating the form or style of a hat.
Attribute	hosierySockRiseCode	HosierySockRiseCode	0..1	A code indicating how high hosiery and socks rise on the wearer's leg.
Attribute	hosierySockStyleCode	HosierySockStyleCode	0..1	A code indicating the style of any tube or tubes of form fitting material intended to cover the arms or legs of a wearer.
Attribute	neckwearTypeCode	NeckwearTypeCode	0..1	A code indicating the shape or use of the neckwear.
Attribute	pantsShortsTypeCode	PantsShortsTypeCode	0..1	A code indicating the style of a pair of pants or shorts.
Attribute	skirtTypeCode	SkirtTypeCode	0..1	A code indicating the primary silhouette or design of a skirt.
Attribute	sweaterPulloverTypeCode	SweaterPulloverTypeCode	0..1	A code indicating the design characteristics of a sweater or pullover.
Attribute	waistbandTypeCode	WaistbandTypeCode	0..*	A code indicating the construction of the waistband of a particular product.
Attribute	waistRiseCode	WaistRiseCode	0..1	A code indicating the measurement of the garment from the bottom of the crotch seam to the top of the waistband.

Content	attribute / role	datatype /secondary class	multiplicity	definition
FootwearProductInformation				A class of attributes providing information on types and styles of footwear.
Attribute	footwearOutsoleTypeCode	footwearOutsoleTypeCode	0..1	A code indicating the type of outsole of the footwear.
Attribute	footwearStyleCode	footwearStyleCode	0..1	A code indicating the form, construction, usage, style, or special purpose of a shoe.
Attribute	heelStyleCode	heelStyleCode	0..1	A code indicating the style heel on a specific type of footwear.
Attribute	toeStyleTypeCode	toeStyleTypeCode	0..1	A code indicating the style and shape of the toe of a shoe.
JewelryProductInformation				A class of attributes providing information on Jewelry products.
Attribute	jewelryStyleCode	JewelryStyleCode	0..1	A code indicating the intended use and general value of the materials used in a piece of jewelry.
Attribute	jewelrySetContentsCode	JewelrySetContentsCode	0..*	A code indicating pieces of jewelry sold together in a set, indicating what items are included in the grouping.
Attribute	necklaceTypeCode	NecklaceTypeCode	0..*	A code indicating the style of a necklace.
Attribute	ringTypeCode	RingTypeCode	0..*	A code Indicating the shape, use, or meaning of a ring.
Attribute	watchCaseShapeCode	WatchCaseShapeCode	0..1	Code indicating the primary shape of the watch case.
BeautyPersonalCareHygieneDetail				A class of attributes providing information on beauty, personal care and hygiene details.
Attribute	perfumeFragranceDilutionClassCode	PerfumeFragranceDilutionClassCode	0..1	The code indicating the dilution class of a fragrance which indicates the concentration of fragrances within a mixture.
DentalProductInformation				A class of attributes providing information on Dental Products.
Attribute	dentalProductFunctionCode	DentalProductFunctionCode	0..*	Indicates, with reference to the product branding, labelling or packaging, the descriptive term that is used by the product manufacturer to identify the type of dental care characteristics.

Content	attribute / role	datatype /secondary class	multiplicity	definition
Attribute	bristleHardnessCode	BristleHardnessCode	0..*	The code indicating the degree of hardness of the bristles, for example for a toothbrush or an interdental brush.
HairProductInformation				A class of attributes providing information on Hair Products
Attribute	hairProductFunctionOrTreatmentCode	HairProductFunctionOrTreatmentCode	0..*	Indicates, with reference to the hair product branding, labelling or packaging, the descriptive term that is used by the product manufacturer to identify different functions of the product and other treatments.
Attribute	hairStyleFixationCode	HairStyleFixationCode	0..*	The code indicating the level of fixation of the hairstyle after using the product, as determined by the ability of the product to hold hair in place.
Attribute	targetHairTypeCode	TargetHairTypeCode	0..*	Indicates, with reference to the product branding, labelling or packaging, the descriptive term that is used by the product manufacturer to identify the hair type for which the product is intended.
Attribute	naturalHairColourCode	NaturalHairColourCode	0..*	Indicates, with reference to the product branding, labelling or packaging, the descriptive term that is used by the product manufacturer to identify the natural colour of the hair for which the product is intended.
Attribute	resultingHairColourShadeCode	ResultingHairColourShadeCode	0..*	The code that defines the hair colour shade the customer wants to achieve by using the product.
SkinProductInformation				A class of attributes providing information on different skin products.
Attribute	skinProductFunctionOrTreatmentCode	SkinProductFunctionOrTreatmentCode	0..*	Indicates, with reference to the product branding, labelling or packaging, the descriptive term that is used by the product manufacturer to identify different functions of the skin care or moisturizing product and other treatments.
Attribute	targetSkinTypeCode	TargetSkinTypeCode	0..*	Indicates, with reference to the product branding, labelling or packaging, the descriptive term that is used by the product manufacturer to identify different types of skin the product is intended for.
HouseholdAndOfficeFurnishingInformation				A class of attributes providing information on household and office furnishing trade items which Includes indoor and outdoor items.
CleaningAidsInformation				A class of attributes to provide information on cleaning products and aids.

Content	attribute / role	datatype /secondary class	multiplicity	definition
Attribute	brushBroomTypeCode	BrushBroomTypeCode	0..1	A code differentiating brush, broom, and dusting tools from one another by concepts such as the surfaces they clean or the accessories they're packaged with.
Attribute	cleaningClothTypeCode	CleaningClothTypeCode	0..1	A descriptive code differentiating cleaning cloths by fabric or intended use.
Attribute	householdCleaningProductTypeCode	HouseholdCleaningProductTypeCode	0..1	A code to differentiate household cleaning products from one another. The codes include, but are not limited to, the room the product is to be used in, the surfaces it's intended to clean, or the type of substance the product is meant to eliminate.
Attribute	laundryDetergentTypeCode	LaundryDetergentTypeCode	0..*	A code differentiating the detergent/soap used for laundry by colour type, fabric type, or washing technique.
Attribute	laundryHangingAidTypeCode	LaundryHangingAidTypeCode	0..1	A code describing various accessories/aids used to hang clothing for storage, display, or laundering purposes.
Attribute	spongeScourerTypeCode	SpongeScourerTypeCode	0..1	A descriptive code differentiating cleaning sponges or scourers from one another.
HouseholdOfficeFurnishing				A class of attributes to provide information on household and furnishing trade items.
Attribute	pillowShapeCode	PillowShapeCode	0..*	A code indicating the shape of a pillow.
Attribute	rugTypeCode	RugTypeCode	0..*	A code indicating the usage or intended room for a particular type of rug.
Attribute	tablewareTypeCode	TablewareTypeCode	0..*	A code indicating the type of a tabletop products.
LinenInformation				A class of attributes providing information on household and office furnishing related to linen
Attribute	towelTypeCode	TowelTypeCode	0..*	Code indicating the type of towel based on intended use.
ClaimDetail				Details on a nutritional claim for a trade item permitted by known regulations for a target market.
Attribute	claimMarkedOnPackage	NonBinaryLogicEnumeration	0..1	Is the claim specified by Claim Type Code in combination with Claim Element Code labelled on the product package.
Attribute	isClaimRegulated	Boolean	0..1	The indicator that specifies whether the claim for the product is regulated for a target market.

Content	attribute / role	datatype /secondary class	multiplicity	definition
Attribute	claimTypeCode	ClaimTypeCode	0..1	The code that states the type of claim applicable to the product. It may be used alone, or in combination with Claim Element Code to identify a specific element, such as a food ingredient, chemical compound or sustainability factor, to which the claim type applies.
Attribute	claimElementCode	ClaimElementCode	0..1	The code that specifies an element, such as a food ingredient, chemical compound or sustainability factor, that is subject to the claim type specified by the Claim Type Code.
TobaccoCannabisInformation				A group of information pertaining to tobacco products, cannabis products, or other products and accessories for smoking. This includes products that contain tobacco, products derived from the cannabis plant, and other smoking accessories designed to enhance the smoking experience.
CannabisInformation				A group of attributes providing information on cannabis products and properties.
Attribute	cannabisCBDTypeCode	CannabisCBDTypeCode	0..*	The code that describes the type of Cannabidiol (CBD) in a product, which is one of many active compounds found in the Cannabis plant.
Attribute	cannabinoidTypeCode	CannabinoidTypeCode	0..1	The code identifying the type of cannabinoid compounds (chemicals that produce psychoactive effects) found in the cannabis product.
CannabinoidContentInformation				Details specific to Cannabinoid content concerning compounds found in the cannabis products.
Attribute	cannabinoidContentCode	CannabinoidContentCode	0..1	The code identifying how cannabinoid content (chemicals that produce psychoactive effects) is measured relative to the form of the product.
Attribute	cannabinoidMaximumRangeValue	Measurement	0..1	The maximum amount of cannabinoid content (chemicals that produce psychoactive effects) per each unit of the cannabis product.
Attribute	cannabinoidMinimumRangeValue	Measurement	0..1	The minimum amount of cannabinoid content (chemicals that produce psychoactive effects) per each unit of the cannabis product.
CannabisPlantInformation				Details specific to cannabis plant type.
Attribute	cannabisCommonName	Description250	0..*	The propriety strain name given by growers or producers of cannabis to identify their product with an existing strain or the name that was used in the legacy market.
Attribute	cannabisPlantTypeCode	CannabisPlantTypeCode	0..1	The code indicating the classification of cannabis species.

Content	attribute / role	datatype /secondary class	multiplicity	definition
Attribute	isCannabisPlantAHybrid	Boolean	0..1	The indicator that specifies whether the cannabis plant is hybrid (a result of crossbreeding two other species of cannabis plants).
TerpeneInformation				Detailed information about terpene(s), an aromatic compound found in some plants and products.
Attribute	maximumTerpeneContent	Measurement	0..1	The maximum amount of terpene(s) in the product.
Attribute	minimumTerpeneContent	Measurement	0..1	The minimum amount of terpene(s) in the product.
Attribute	terpeneTypeCode	TerpeneTypeCode	1..1	The code indicating the type of terpene(s) (a compound that gives a product a distinctive smell or taste, especially cannabis) contained in the product.
Attribute	terpeneSourceCode	TerpeneSourceCode	0..1	The code indicating the source of terpenes used in the products.
SmokingAccessories				A group of attributes providing information on accessories and devices for smoking / inhaling vapor containing nicotine, cannabis or other chemicals.
Attribute	cartridgeDeviceCompatibilityCode	CartridgeDeviceCompatibilityCode	0..1	The code indicating the compatibility of the cartridge to the battery or vape pen device.
Attribute	vapeDeviceTypeCode	VapeDeviceTypeCode	0..1	The code indicating the device type for vape or electronic cigarette products, a device designed for inhaling vapor containing nicotine, cannabis or other chemicals.
Attribute	vapingKitCompatibilityCode	VapingKitCompatibilityCode	0..*	The code indicating that the vaping kit is compatible with e-liquids, dry herb or both.

5.52 Promotional Item Information Module

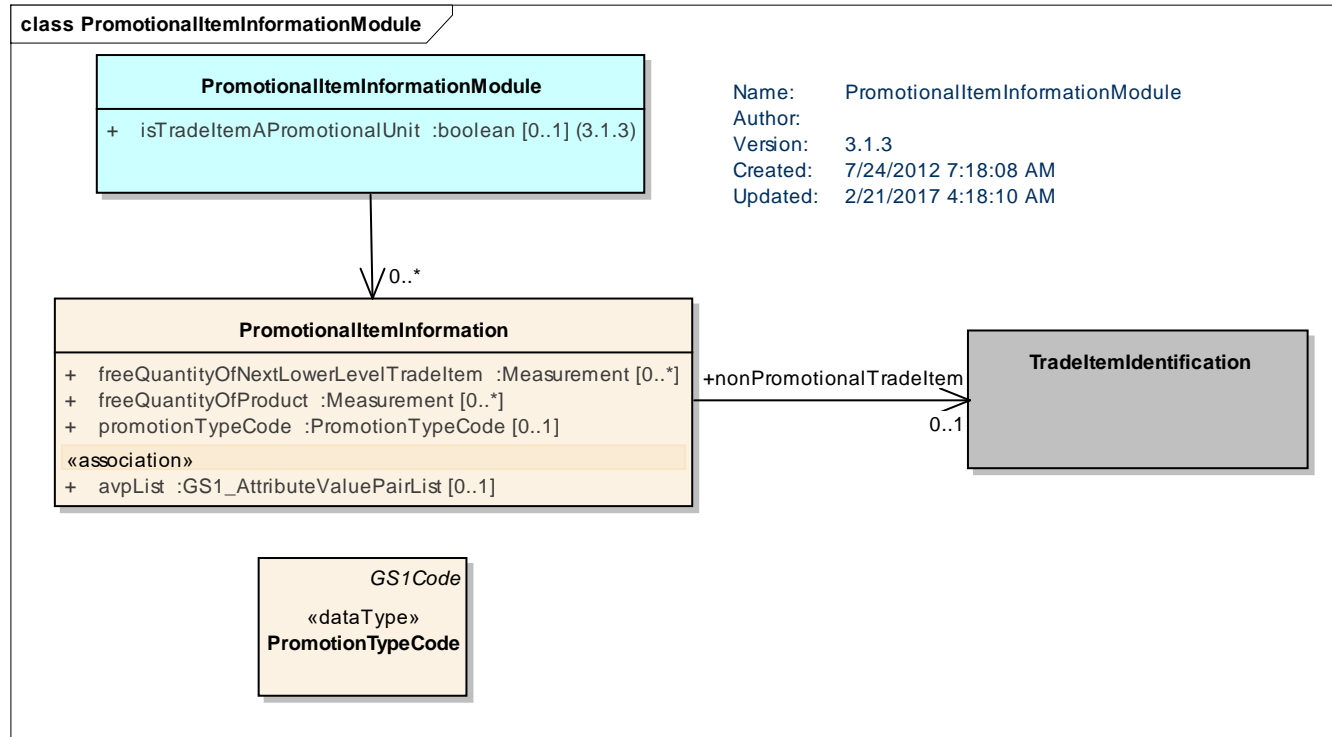

Note: Common class (in grey) is located in Shared Common Library.

Content	attribute / role	datatype /secondary class	multiplicity	definition
PromotionalItemInformation				Provides details of the type of promotional item and its relationship to the non-promotional item.

Content	attribute / role	datatype /secondary class	multiplicity	definition
Association	nonPromotionalTradeItem	TradeItemIdentification	0..1	The GTIN of the standard Trade Item. Used to indicate which trade item the promotional trade item replaces or coexists with. To enable the linking of identification and there for of information be-teen the two trade items.
Association	avpList	GS1_AttributeValuePairList	0..1	Attribute value pair information.
Attribute	freeQuantityOfNextLowerLevelTradeItem	Measurement	0..*	The numeric quantity of free items in a combination pack. If the free quantity promotional trade item is simple or is a multi-pack the free quantity is populated. The unit of measure used for the free quantity of next lower level must be the same as the unit of measure of the Net Content of the Child Trade Item.
Attribute	freeQuantityOfProduct	Measurement	0..*	To indicate the quantity which is free. It is needed to update the price per unit of measure as displayed on the shelves. The unit of measure must be the same as the unit of measure of the Net Content. If the free quantity is expressed on the package it must be converted to a quantity expressed in the same unit of measure as the net content in the message.
Attribute	promotionTypeCode	PromotionTypeCode	0..1	Used to identify the different types of free quantity promotional trade items and the nature of the link between the standard trade item and the promotional trade item.
PromotionalItemInformationModule				A module providing details of the type of promotional item.
Attribute	isTradeItemAPromotionalUnit	boolean	0..1	An indicator used to point out those trade items which are promotions from regular line articles for example a bundle containing one bottle or shampoo and one of conditioner that is released for a three-month period will have to indicate 'true' in 'istradeitempromotionalpackunit', while a soda six-pack would leave it blank or indicate 'no' as it is a regular trade item.
Association		PromotionalItemInformation	0..*	Details of the type of promotional item.

5.53 Propellant Information Module

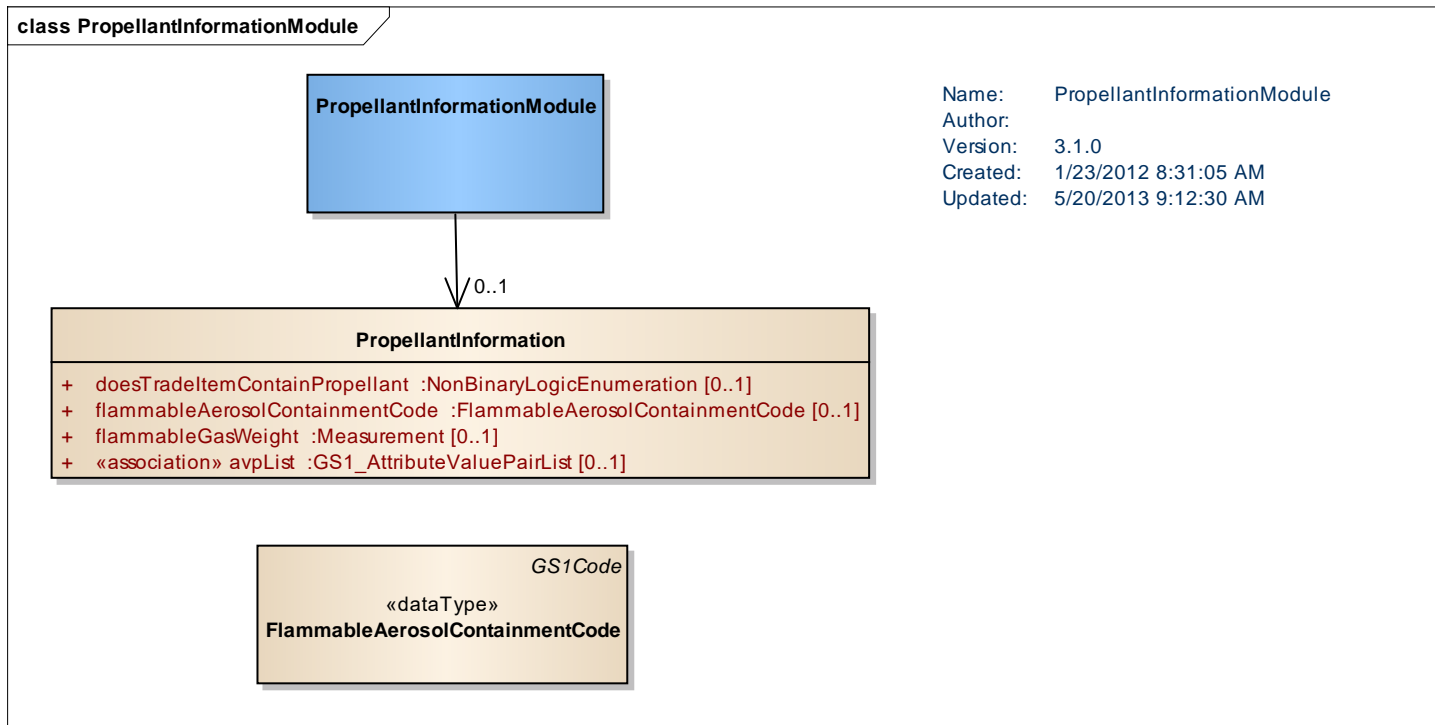

content	attribute / role	datatype /secondary class	multiplicity	definition
PropellantInformation				Information on compressed gas or propellant contained in the trade item.
Association	avpList	GS1_AttributeValuePairList	0..1	Attribute value pair information.
Attribute	doesTradelItemContainPropellant	NonBinaryLogicEnumeration	0..1	Indicates if a trade item contains a compressed gas or propellant.
Attribute	flammableAerosolContainmentCode	FlammableAerosolContainmentCode	0..1	Determines whether the propellant in the trade item is an aerosol and whether the aerosol is considered flammable.
Attribute	flammableGasWeight	Measurement	0..1	This is the weight of the flammable gas in the trade item. Note: Per submitter this is expressed in the UK in grammes This attribute is required if the item is an aerosol which contains flammable gas (FLAMMABLE_AEROSOL).

content	attribute / role	datatype /secondary class	multiplicity	definition
PropellantInformationModule				Information on compressed gas or propellant contained in the trade item.
Association		PropellantInformation	0..1	Propellant details for a trade item.

5.54 Publication Title Rating Module

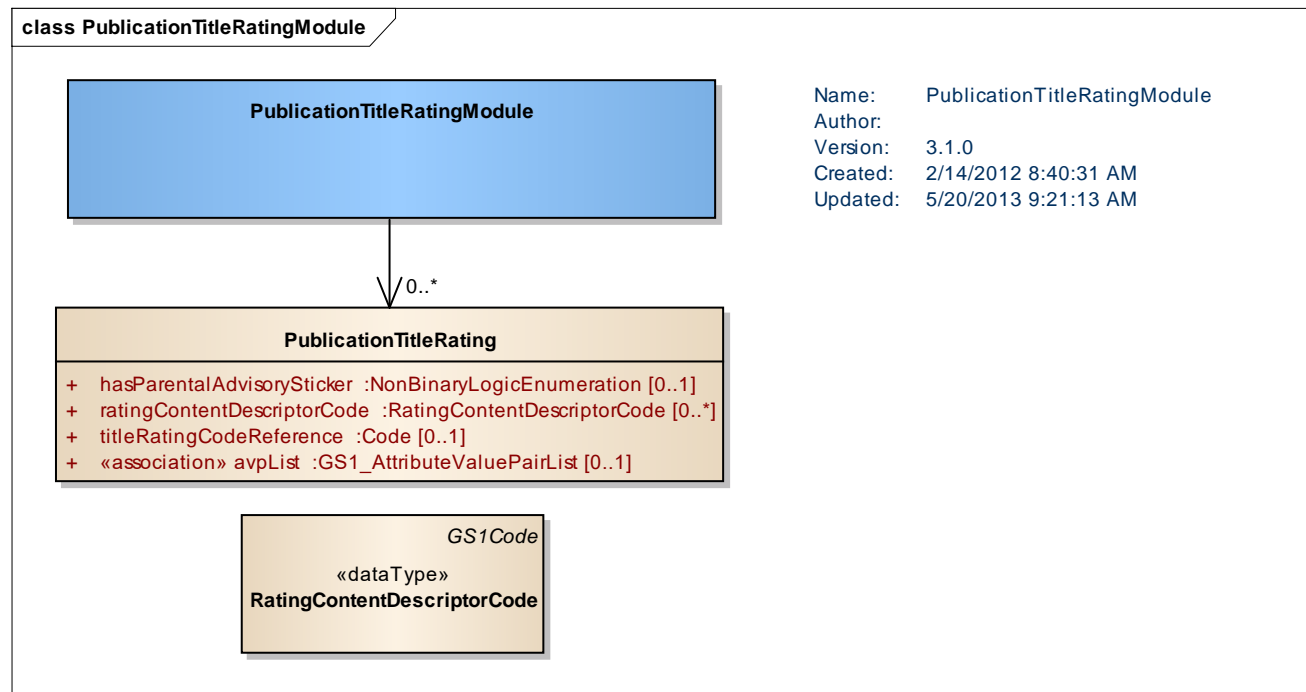

content	attribute / role	datatype /secondary class	multiplicity	definition
PublicationTitleRatingModule				A module containing information regarding the content viewer maturity rating for an entertainment product.



content	attribute / role	datatype /secondary class	multiplicity	definition
Association		PublicationTitleRating	0..*	Information regarding the content viewer maturity rating for an entertainment product.
PublicationTitleRating				Information regarding the content viewer maturity rating for an entertainment product.
Association	avpList	GS1_AttributeValuePairList	0..1	Attribute value pair information.
Attribute	hasParentalAdvisorySticker	NonBinaryLogicEnumeration	0..1	Indication of the presence of parental advisory sticker.
Attribute	ratingContentDescriptorCode	ratingContentDescriptorCode	0..*	A code that identifies one or several elements that have triggered a particular rating and/or may be of interest or concern.
Attribute	titleRatingCodeReference	Code	0..1	<p>A rating assigned to the title by a country, industry or volunteer organization that may be of interest or concern to the consumer.</p> <p>GS1 Code List used differs based on product type:</p> <ul style="list-style-type: none"> Title Rating Code (Games) Title Rating Code (Film).

5.55 Referenced File Detail Information Module

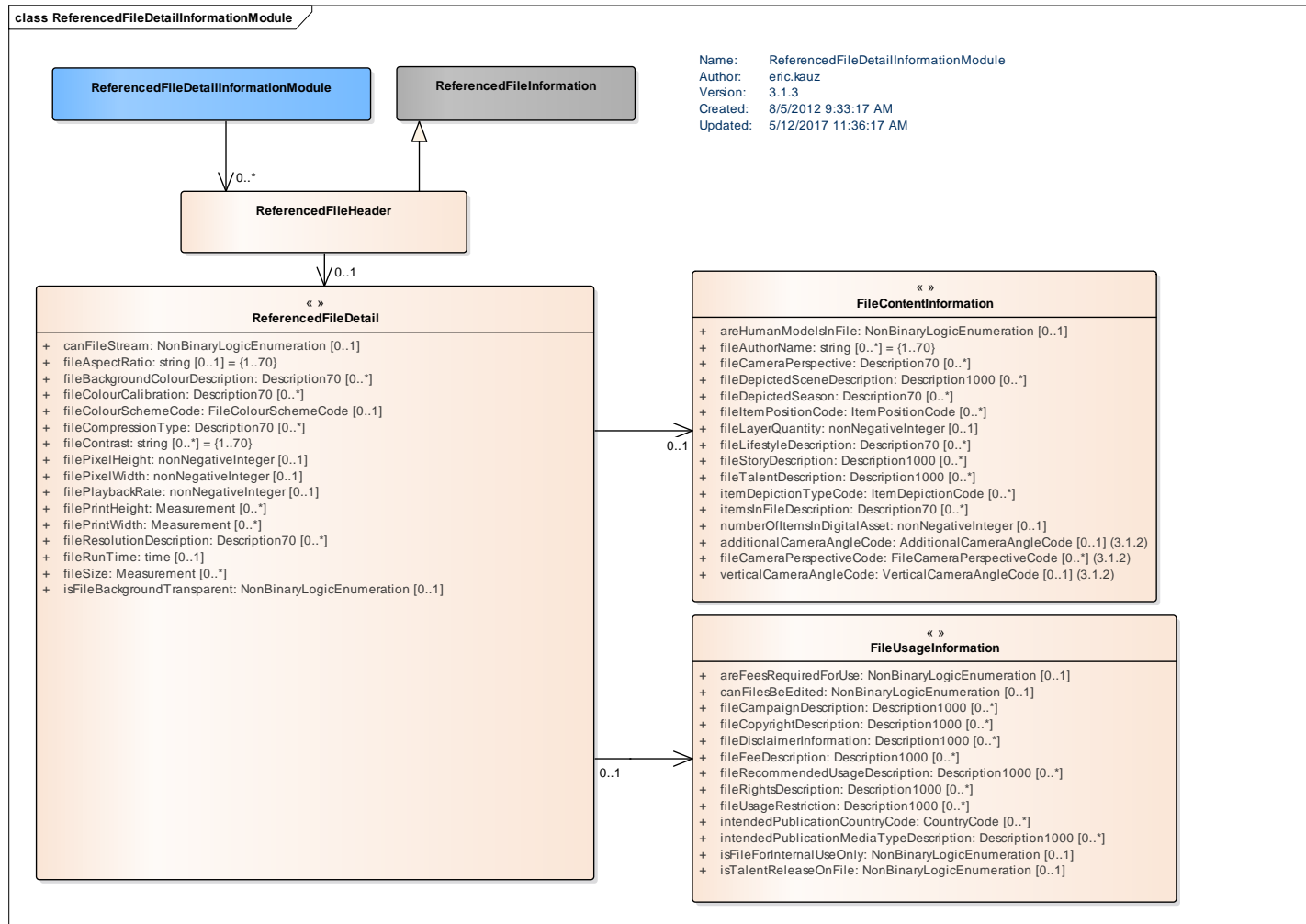

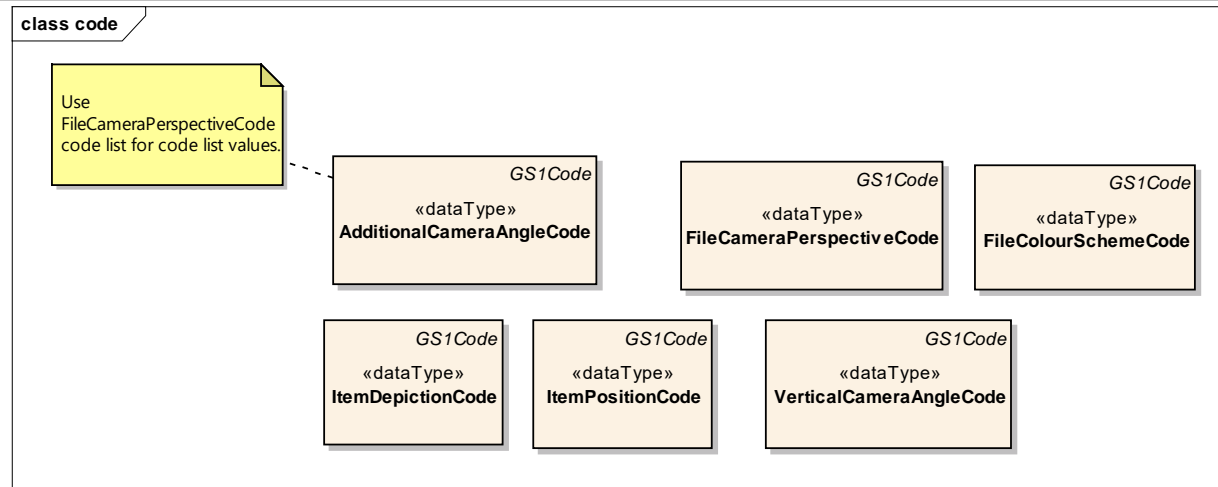

content	attribute / role	datatype / secondary class	multiplicity	definition
ReferencedFileDetailInformationModule				Information specifying a link to a file external to the message itself.
Association		ReferencedFileHeader	0..*	Information specifying a link to a file external to the message itself.
ReferencedFileHeader				Basic referenced file information.
Association	<Generalization>	ReferencedFileInformation	1..1	Imports information contained in ReferencedFileInformationClass into the ReferencedFileHeader
Association		ReferencedFileDetail	0..1	Information specifying a link to a file external to the message itself.
ReferencedFileDetail				Information specifying a link to a file external to the message itself.
Association		FileUsageInformation	0..1	Information on usage of a referenced file.
Association		FileContentInformation	0..1	Information on the content of the referenced file.
Association	avpList	GS1_AttributeValuePairList	0..1	Attribute value pair information.

content	attribute / role	datatype /secondary class	multipl city	definition
Attribute	canFileStream	NonbinaryLogicEnumeration	0..1	An indicator that the digital asset is compressed to start displaying/running before fully uncompressing.
Attribute	fileAspectRatio	string	0..1	A description of the aspect ratio used to determine how a digital asset fits on a page or monitor.
Attribute	fileBackgroundColourDescription	Description70	0..*	A description of the colour for the background in the digital asset. The background is the area in the asset which surrounds the item.
Attribute	fileColourCalibration	Description70	0..*	The colour calibration fashion used in the creation of the digital asset for example: Kodak, Heidelberg CMM, Apple colourSync, etc.
Attribute	fileColourSchemeCode	FileColourSchemeCode	0..1	The type of colour scheme used in the digital asset.
Attribute	fileCompressionType	Description70	0..*	A description of the compression method used to reduce the file size stored at the link. This information is used to aid the user in choosing the correct program to extract the file. Examples include Quick Time, Real Player, mpg, WinZip, etc.
Attribute	fileContrast	string	0..*	The contrast used in the digital asset. Contrast is the difference in brightness between light and dark areas of an image. Contrast determines the number of shades in the image.
Attribute	filePixelHeight	nonNegativeInteger	0..1	The number of pixels along the vertical axis of the image.
Attribute	filePixelWidth	nonNegativeInteger	0..1	The number of pixels along the horizontal axis of the image.
Attribute	filePlaybackRate	nonNegativeInteger	0..1	The targeted frame rate for the display of the digital asset, expressed as an integer representing the number of frames per second.
Attribute	filePrintHeight	Measurement	0..*	The number of pixels along the vertical axis of the image.
Attribute	filePrintWidth	Measurement	0..*	The number of pixels along the horizontal axis of the image.
Attribute	fileResolutionDescription	Description70	0..*	The resolution of the file. Knowing the resolution will allow the user to be able to determine the best system with which to utilize the file.

content	attribute / role	datatype /secondary class	multiplcity	definition
Attribute	fileRunTime	time	0..1	The playback or running length of time for the digital asset. This most common is in reference to video or audio files, but is not limited to them. This would be expressed in hours, minutes and second (hh:mm:ss).
Attribute	fileSize	Measurement	0..*	The size of the file as it is stored in an uncompressed format.
Attribute	isFileBackgroundTransparent	NonbinaryLogicEnumeration	0..1	An indicator of whether or not the background used in the file is transparent. Having a transparent background would allow a recipient to place the file into any setting necessary.
FileContentInformation				Information on file content for an external file.
Attribute	additionalCameraAngleCode	AdditionalCameraAngleCode	0..1	An additional camera angle used to take a picture of the trade item for example ZOOM_VIEW. If this attribute is not populated, the assumption is a full trade item view. Uses FileCameraPerspectiveCode code list.
Attribute	areHumanModelsInFile	NonbinaryLogicEnumeration	0..1	An indicator whether or not the item is shown or depicted with human models.
Attribute	fileAuthorName	string	0..*	The organization(s) or person(s) who is responsible for creating the digital asset.
Attribute	fileCameraPerspective	Description70	0..*	A description of the angle of perspective used by the camera in the capture of the digital asset.
Attribute	fileCameraPerspectiveCode	fileCameraPerspectiveCode	0..*	A code describing the angle, perspective or the focal lens setting used by the camera in the capture of the digital asset.
Attribute	fileDepictedSceneDescription	Description1000	0..*	The scene or location used as a setting or backdrop in the digital asset.
Attribute	fileDepictedSeason	Description70	0..*	A description of the season shown or depicted within the digital asset. (e.g. Winter, Spring).
Attribute	fileItemPositionCode	ItemPositionCode	0..*	A description of how the item is placed in the digital asset for example the item is propped (leaning against an object) or held (being held by a model).
Attribute	fileLayerQuantity	nonNegativeInteger	0..1	The number of layers in the digital asset.

content	attribute / role	datatype /secondary class	multiplcity	definition
Attribute	fileLifestyleDescription	Description70	0..*	The lifestyles to which this digital asset can be used. For example psychographic, demographic, age, etc.
Attribute	fileStoryDescription	Description1000	0..*	A description of the storyboard or plot of the digital file.
Attribute	fileTalentDescription	Description1000	0..*	The specific identification of the talent used in the file. For example, may identify a celebrity as the spokesperson for the product as included in the asset.
Attribute	itemDepictionTypeCode	ItemDepictionCode	0..*	The state of the item as it is being depicted in the digital assets for example gift wrapped or assembled.
Attribute	itemsInFileDescription	Description70	0..*	A description of the additional items shown or depicted in the digital asset.
Attribute	numberOfItemsInDigitalAsset	nonNegativeInteger	0..1	The number of items in the digital asset, where the asset contains more than one item.
Attribute	verticalCameraAngleCode	verticalCameraAngleCode	0..1	The vertical angle used to photograph an object expressed as a code for example PARALLEL.
FileUsageInformation				Information on usage for an external file.
Attribute	areFeesRequiredForUse	NonbinaryLogicEnumeration	0..1	An indicator whether or not a fee is required for the use of this digital asset.
Attribute	canFilesBeEdited	NonbinaryLogicEnumeration	0..1	An indicator of whether the user or recipient of the digital asset can edit it prior to use or as a function of using the asset. Some digital assets are designed such that the recipient can edit the asset to meet the needs of a final output.
Attribute	fileCampaignDescription	Description1000	0..*	A reference to a specific communication project to which the digital asset is associated, such as the Back To School Campaign. A campaign is a marketing term used to describe the event, sale, promotion, or other program for which this digital asset is designed to be part.
Attribute	fileCopyrightDescription	Description1000	0..*	A description of any Copyright notice which pertains to the digital asset.
Attribute	fileDisclaimerInformation	Description1000	0..*	A description expressing any disclaimers which pertain to the digital asset. (e.g. Item may be smaller than appears).

content	attribute / role	datatype /secondary class	multiplcity	definition
Attribute	fileFeeDescription	Description1000	0..*	A description of the fees that are applicable to use of the digital asset. This attribute may be a list of actual fees, a description of the fee structure, or contact information to find out the fees.
Attribute	fileRecommendedUsageDescription	Description1000	0..*	A textual description of the recommended use of the asset in an easy to understand fashion such that all parties, regardless of specific expertise, can understand use of the asset. This element's intention is to "translate" complicated characteristics into a simpler textual representation. Examples: <ul style="list-style-type: none"> If the characteristics of the external file are a resolution of 1775 x 1230 pixels, colour space RGB 8 bit by colour, format TIF or JPG compressed to maximum quality. Recommended Usage might be "print maximum quality" and/or "web publishing". If the characteristics of the external file are mpg, Recommended Usage might be "web publishing". As this value may not be the same for all digital assets, this attribute should be linked to a specific URL.
Attribute	fileRightsDescription	Description1000	0..*	The structure for Digital Rights Management (DRM) which is in place on the file. This could be ID and location of external Intellectual Property Management & Protection (IPMP) system for lookup of usage rights. Presence of a value for this attribute signifies that the file uses a DRM.
Attribute	fileUsageRestriction	Description1000	0..*	A description of any restrictions on the ability of the recipient's to use of the asset.
Attribute	intendedPublicationCountryCode	CountryCode	0..*	The country/countries in which the digital asset is designed to be used.
Attribute	intendedPublicationMediaTypeDescription	Description1000	0..*	The media types with which the digital asset was designed to be utilized, such as Web, Catalogue, Circular among others.
Attribute	isFileForInternalUseOnly	NonBinaryLogicEnumeration	0..1	An indicator whether or not the file is intended for internal use only and not for general publication.
Attribute	isTalentReleaseOnFile	NonBinaryLogicEnumeration	0..1	An indicator whether or not the owner of the asset has a talent release on file. This applies to files where talent or a model is used.

5.56 Regulated Trade Item Module



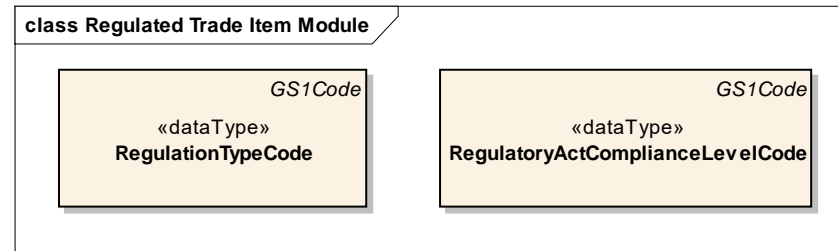

content	attribute / role	datatype /secondary class	multiplcity	definition
RegulatedTradeItemModule				A module containing Information on applicable government regulations a trade item is in compliance with.
Attribute	doesTradeItemContainElectricalComponents	NonBinaryLogicEnumeration	0..1	An Indication for regulation purposes of the existence of wires, circuits, circuit boards, or other electrical components in the trade item. The trade item may be powered by many types of energy such as solar, electricity, fossil fuel, batteries and/or generate some form of energy.
Association		RegulatoryInformation	0..*	Information on applicable government regulations a trade item is in compliance with.
PermitIdentification				Contains the information regarding the permit identification.
Attribute	permitEndDateTime	dateTime	0..1	The date on which the permit expires.
Attribute	permitStartDateTime	dateTime	0..1	The start date on which the permit is effective.
Attribute	regulatoryPermitIdentification	string	1..1	Identification of the permit or license given by the regulatory agency.
Association	avpList	GS1_AttributeValuePairList	0..1	Attribute value pair information.
RegulatoryInformation				Information on applicable government regulations a trade item is in compliance with.
Association		PermitIdentification	0..*	Permit information for a regulation.
Attribute	isPackagingMarkedWithRegulatoryCompliance	NonBinaryLogicEnumeration	0..1	Indicator of whether the packaging is marked with a regulatory compliance code.

content	attribute / role	datatype /secondary class	multiplcity	definition
Attribute	regulatoryAct	string	0..1	The name given to the requirement assigned by the regulatory agency.
Attribute	regulatoryAgency	string	0..1	The required information is the name of the specific entity in charge of issuing the permit to a company.
Attribute	regulationPictogramOr WarningQuantity	NonNegativeInteger	0..1	The number of pictograms or warnings on a product package according to regulations. Example Mexican and Chilean Food labelling regulation.
Attribute	regulationTypeCode	RegulationTypeCode	0..*	A code that indicates that a trade item is in compliance with specific applicable government regulations.
Attribute	isTradeItemRegulation Compliant	NonBinaryLogicEnumeration	0..1	The indicator specifying whether the product is compliant, not compliant or not applicable to the regulation associated with the Regulation Type Code.
Attribute	regulatoryActComplianceLevelCode	RegulatoryActComplianceLevelCode	0..1	Code that compares the amount/level of the product or its composition with threshold amounts/levels defined by a regulation indicated in attribute regulationTypeCode. This can vary for each regulation and market or region. For example: concentration limit for restricted explosive precursors defined by EU Regulation 2019/1148. The level of containment of specific toxicants for a product which contains carcinogens and/or reproductive toxicants established in California's Proposition 65 (Prop 65), etc.
Attribute	regulationCommunityLevelCode	RegulationCommunityLevelCode	0..1	The type of territory the regulation is issued by for example a nation or territory considered as an organized political community under a government. Examples include; UNION, MUNICIPALITY, PROVENCE_OR_STATE.
Attribute	regulationRestrictionsAndDescriptors	Description5000	0..*	A textual detail needed by trading partners that explains any restrictions and/or descriptors explaining any information helpful about a regulation.
Attribute	regulationRestrictionCommunityIdentifier	string	0..*	An Identifier identifying the community like ISO country, ISO sub division, Municipal zip code for example 10001, 840, US-AR.

content	attribute / role	datatype /secondary class	multiplcity	definition
Attribute	regulationLevelCodeReference	Code	0..*	An external code associated with a specific warning type and possibly a description that helps recipients identify items of similar levels of warnings, that cannot be obtained from a description. The information provided in this attribute may come from a specific article in the full Regulation. For examples : - if the regulationTypeCode is "SMALL_PARTS" the regulationLevelCodeReference would be "Level 5" with codeDescription "Not for ages under 3" - if the regulationTypeCode is "BIOCIDE_REGULATION" the regulationLevelCodeReference would be "PT1" with codeDescription "Human hygiene"
Association	avpList	GS1_AttributeValuePairList	0..1	Attribute value pair information.

5.57 Safety Data Sheet Module

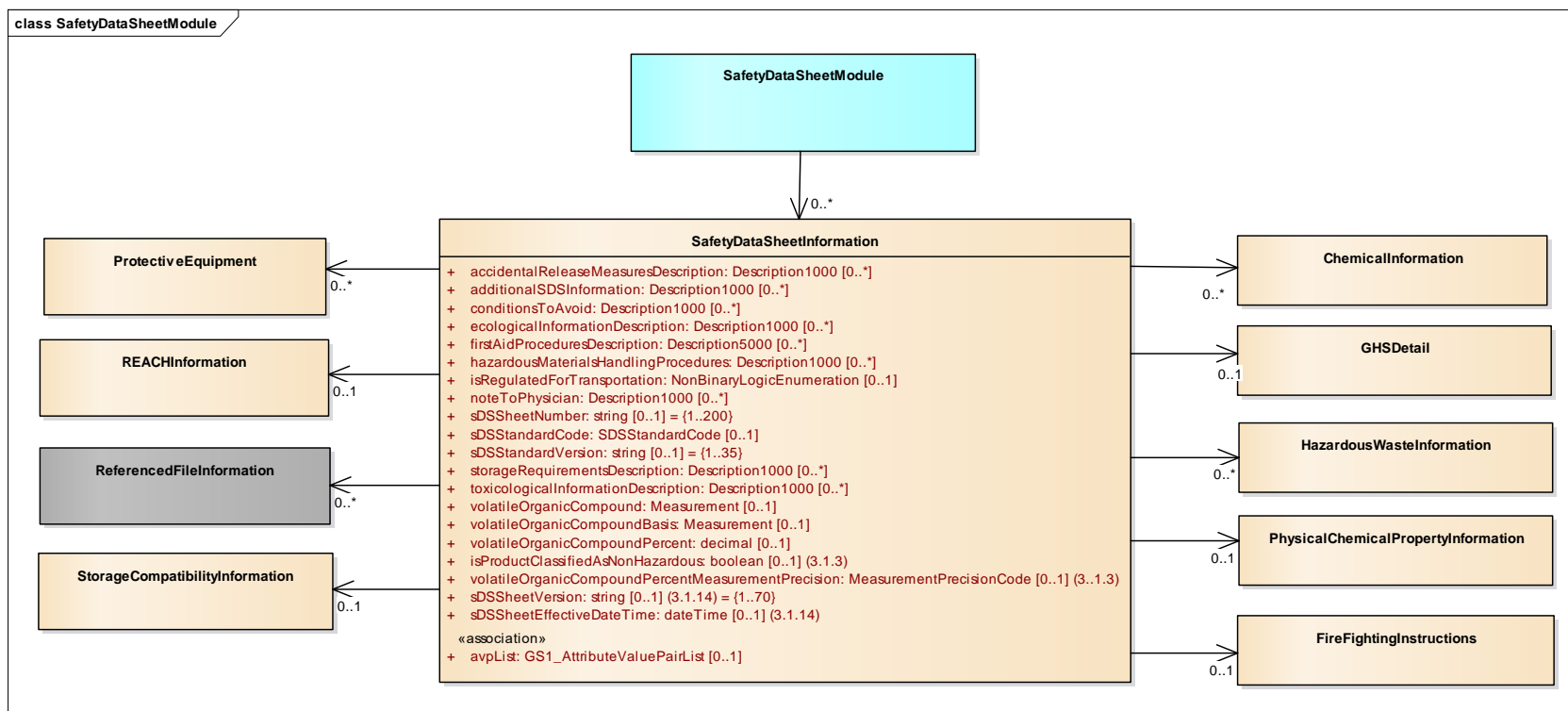

Note: Common class (in grey) is located in the GDSN Common Library.

Content	attribute / role	datatype /secondary class	multiplcity	definition
SafetyDataSheetModule				A module containing information usually contained on a safety data sheet or on a material safety data sheet as it is referred to in some target markets.
Association		SafetyDataSheetInformation	0..*	Trade item information usually contained on a safety data sheet or on a material safety data sheet as it is referred to in some target markets.

Content	attribute / role	datatype /secondary class	multiplcity	definition
SafetyDataSheetInformation				Trade item information usually contained on a safety data sheet or on a material safety data sheet as it is referred to in some target markets.
Association		PhysicalChemicalPropertyInformation	0..1	Physical or chemical property information expressed on an SDS/MSDS.
Association		ChemicalInformation	0..*	Chemical Information expressed on an SDS/MSDS.
Association		GHSDetail	0..1	Information on GHS for a safety data sheet.
Association		HazardousWasteInformation	0..*	Hazardous waste information expressed on an SDS/MSDS.
Association		REACHInformation	0..1	REACH information expressed on an SDS/MSDS.
Association		ProtectiveEquipment	0..*	Protective equipment recommended for a chemical.
Association		ReferencedFileInformation	0..*	Referenced File information for an SDS/MSDS.
Association		StorageCompatibilityInformation	0..1	Storage compatibility information expressed on an SDS/MSDS.
Association		FireFightingInstructions	0..1	Fire fighting information expressed on an SDS/MSDS.
Association	avpList	GS1_AttributeValuePairList	0..1	Attribute value pair information.
Attribute	accidentalReleaseMeasuresDescription	Description1000	0..*	A description of the method of clean-up or pick up for example Chemtrack number in relation to any hazardous materials regulated by ADR (European Agreement concerning the International Carriage of Dangerous Goods by Road).
Attribute	additionalSDSInformation	Description1000	0..*	A description field for other information regarding the MSDS that is not in the other sections. For example, additional contact information, or sustainability statement, other information.

Content	attribute / role	datatype /secondary class	multiplcity	definition
Attribute	conditionsToAvoid	Description1000	0..*	Conditions, environments, or other chemicals that when mixed with a product can cause an adverse reaction. For example exposing acids to bases.
Attribute	ecologicalInformationDescription	Description1000	0..*	Any information required on the SDS/MSDS in relationship to any effect of the chemical on the environment.
Attribute	firstAidProceduresDescription	Description5000	0..*	A description of any first aid procedures necessary in case of exposure. Note: This is used in compliance with ADR (European Agreement concerning the International Carriage of Dangerous Goods by Road).
Attribute	hazardousMaterialsHandlingProcedures	Description1000	0..*	Hazardous materials handling procedures are a description of how the product should be handled in relation to potential hazardous materials for example "do not handle around food, avoid contact with eyes, keep container closed.
Attribute	isRegulatedForTransportation	NonBinaryLogicEnumeration	0..1	An indicator whether the Trade Item is regulated for shipment by any agency.
Attribute	noteToPhysician	Description1000	0..*	A description of any measures a physician should take to treat patient for exposure for example "exposure may cause cardio irritability and what drugs not to be given in relation to any hazardous materials. This requested for hazardous materials regulated by ADR (European Agreement concerning the International Carriage of Dangerous Goods by Road).
Attribute	sDSSheetEffectiveDateTime	dateTime	0..1	Date/time from which the content of the safety data sheet is valid. When issuing the data sheet for the first time, this date indicates the creation date. In case of updates, this date indicates the date of the last revision.
Attribute	sDSSheetNumber	string	0..1	Manufacturer's identification number for the safety data sheet for a trade item.
Attribute	sDSSheetVersion	string	0..1	The safety data sheet version that uniquely identifies the release version of the safety data sheet. This version is needed to make data sheets versionable and revisions comprehensible.
Attribute	sDSStandardCode	SDSStandardCode	0..1	A code describing the standard used to create the MSDS that is pointed to in the SDS URL.
Attribute	sDSStandardVersion	string	0..1	The version of the standard used to create the MSDS that is pointed to in the SDS URL.

Content	attribute / role	datatype /secondary class	multiplcity	definition
Attribute	storageRequirementsDescription	Description1000	0..*	A description how to safely store the Trade Item for example cool, dry, not near flame, adequate ventilation.
Attribute	toxicologicalInformationDescription	Description1000	0..*	A general description of any information on any toxic properties as included on the MSDS for example precautionary text on a label. This text should describe the key issues with the product in regards to toxicity.
Attribute	volatileOrganicCompound	Measurement	0..1	Volatile Organic Compound is the amount of an item that is a volatile organic compound expressed as a measurement. Volatile is where the compound can evaporate or vaporize into the atmosphere.
Attribute	volatileOrganicCompoundBasis	Measurement	0..1	The basis measurement for a Volatile Organic Compound when expressed as an amount for example 1 L in the case of 5 ML per 1 LT.
Attribute	volatileOrganicCompoundPercent	decimal	0..1	Volatile Organic Compound by weight is the percentage of an item that is a volatile organic compound. Volatile is where the compound can evaporate or vaporize into the atmosphere.
Attribute	isProductClassifiedAsNonHazardous	Boolean	0..1	Indication that the product is classified, on its own or when aggregated, as non-hazardous waste according to EPA's Resource Conservation and Control ACT (RCRA) when disposed. Under RCRA (40 CFR 261.31-33) hazardous wastes are those determined by EPA to be hazardous including those classified as hazardous and if products exhibit one of the four characteristics (defined in 40 CFR Part 261.21-24). Hazardous wastes are divided into listed wastes, characteristic wastes, universal wastes, and mixed wastes. Specific procedures determine how waste is identified, classified, listed, and delisted. RCRA mandates strict controls over disposal of hazardous waste. These listed wastes are divided into three categories: K-list, F-list, and the P and U-Lists. Characteristic wastes include wastes that exhibit ignitability, corrosivity, reactivity or toxicity. Universal wastes include batteries, pesticides, mercury-containing products and lamps. Examples include computer equipment, lead-containing products, and applicable cleaning chemicals.
Attribute	volatileOrganicCompoundPercentMeasurementPrecision	Measurement PrecisionCode	0..1	The measurement precision used to determine the percentage of an item that is a volatile organic compound.

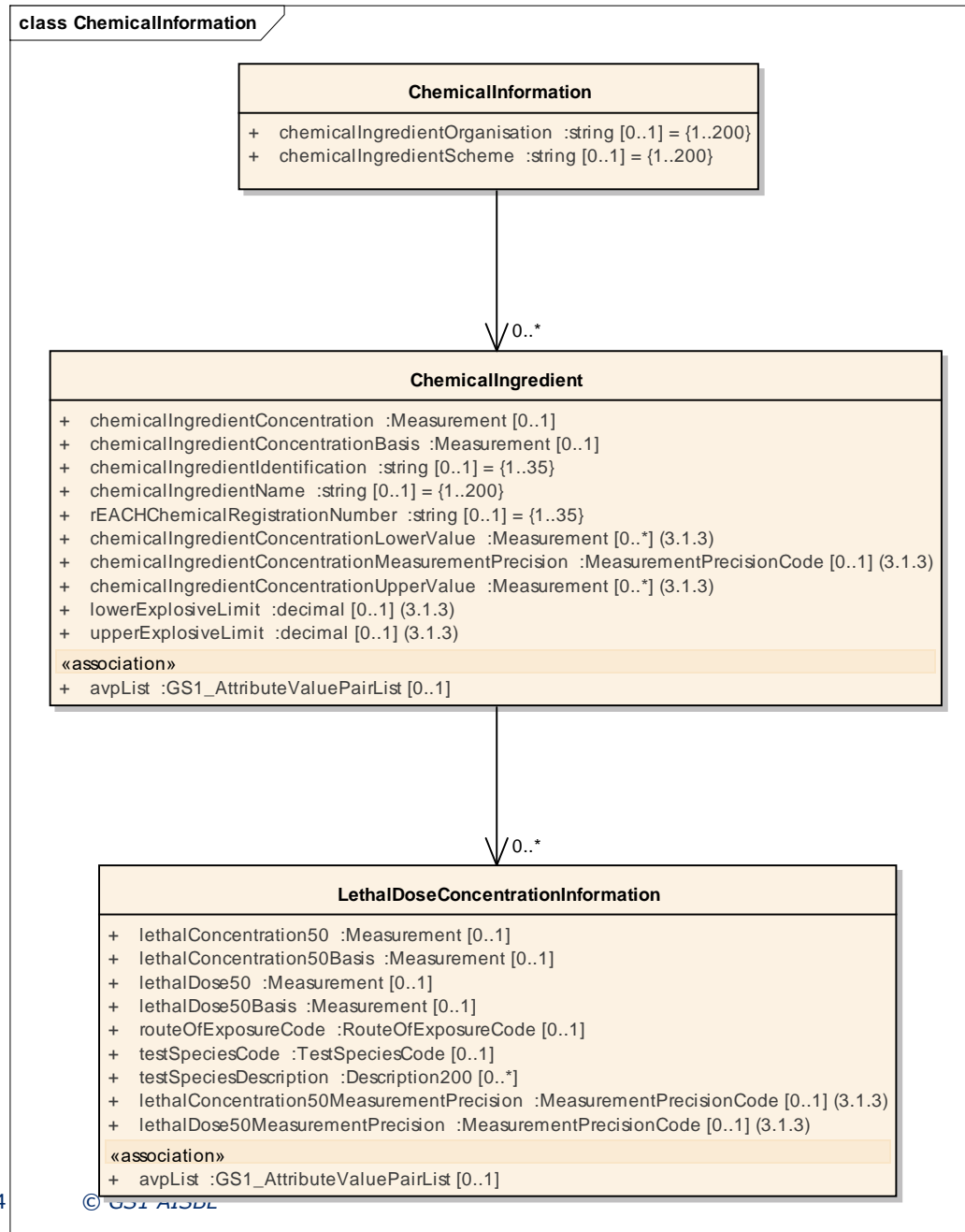

content	attribute / role	datatype /secondary class	multiplicity	definition
ChemicalInformation				Detailed information on any chemical ingredients contained within the trade item.
Association		ChemicalIngredient	0..*	Chemical ingredient details for a specific chemical ingredient.
Attribute	chemicalIngredientOrganisation	string	0..1	An organization managing a chemical ingredient identification scheme.
Attribute	chemicalIngredientScheme	string	0..1	A managed list of chemical ingredient identifications for example CAS.
ChemicalIngredient				Chemical ingredient details for a specific chemical ingredient.
Association		LethalDoseConcentrationInformation	0..*	Lethal Dose and lethal concentration details for a chemical ingredient.
Attribute	chemicalIngredientConcentration	Measurement	0..1	The percentage or amount of a chemical ingredient in relation to the total composition of the product.
Attribute	chemicalIngredientConcentrationBasis	Measurement	0..1	The basis amount used to express the chemical ingredient concentration.
Attribute	chemicalIngredientIdentification	string	0..1	A unique number to identify a chemical used to cross reference regulated lists of chemicals for example CAS number.
Attribute	chemicalIngredientName	string	0..1	The common name of the chemical ingredient.
Attribute	rEACHChemicalRegistrationNumber	string	0..1	A unique registration number for a chemical for a company. This is issued by the European Chemical Agency (ECHA) and is unique per chemical.
Attribute	chemicalIngredientConcentrationLowerValue	Measurement	0..*	The lower value of a range of a chemical ingredient concentration.
Attribute	chemicalIngredientConcentrationMeasurementPrecision	MeasurementPrecisionCode	0..1	The measurement precision used to determine the concentration of a chemical ingredient for example EXACT.
Attribute	chemicalIngredientConcentrationUpperValue	Measurement	0..*	The upper value of a range of a chemical ingredient concentration.
Attribute	lowerExplosiveLimit	decimal	0..1	The low end value expressed as a percent by volume that the mixture is still flammable.
Attribute	upperExplosiveLimit	decimal	0..1	The high end value expressed as a percent by volume that the product will still explode.

content	attribute / role	datatype /secondary class	multiplicity	definition
Association	avpList	GS1_AttributeValuePairList	0..1	Attribute value pair information.
LethalDoseConcentrationInformation				Details on any lethal dose or concentration of a chemical in a trade item.
Attribute	lethalConcentration50	Measurement	0..1	Median Lethal Concentration is a statistically derived concentration of a substance that can be expected to cause death in 50% of test animals. It is usually expressed as the weight of substance per weight or volume of water, air or feed, e.g., mg/l, mg/kg or ppm.
Attribute	lethalConcentration50Basis	Measurement	0..1	The basis measurement for the measurement of Median Lethal Concentration for example 1 LT in the ratio 10 MG/1 LT .
Attribute	lethalDose50	Measurement	0..1	Lethal Dose 50 is a statistically derived single dose that can be expected to cause death in 50% of the test animals when administered by the route indicated (oral, dermal, inhalation). It is expressed as a weight of substance per unit weight of animal, e.g., mg/kg.
Attribute	lethalDose50Basis	Measurement	0..1	The basis measurement for the measurement of a Lethal Dose for example 1 LT in the ratio 10 MG/1 LT.
Attribute	routeOfExposureCode	RouteOfExposureCode	0..1	The means by which living organisms can come into contact with a hazardous substance for example dermal, Inhalation, ingestion.
Attribute	testSpeciesCode	TestSpeciesCode	0..1	The species of animal that was used for determining LC and LD 50 expressed as a code for example RAT.
Attribute	testSpeciesDescription	Description200	0..*	A description of any species of animal that was used for determining LC and LD other than the norm.
Attribute	lethalConcentration50MeasurementPrecision	MeasurementPrecisionCode	0..1	The measurement precision used to determine the lethal concentration 50 for example EXACT.
Attribute	lethalDose50MeasurementPrecision	MeasurementPrecisionCode	0..1	The measurement precision used to determine the determine the lethal dose for example EXACT.
Association	avpList	GS1_AttributeValuePairList	0..1	Attribute value pair information.

class fireFightingInstructions

FireFightingInstructions
- extinguishingMediaDescription :Description1000 [0..*]
- fireFighterProtectiveEquipmentDescription :Description1000 [0..*]
- flammablePropertiesDescription :Description1000 [0..*]

content	attribute / role	datatype /secondary class	multiplicity	definition
FireFightingInstructions				Any instructions on how to handle a fire related to a specific trade item.
Attribute	extinguishingMediaDescription	Description1000	0..*	A description of any substance that can be used to extinguish a fire, carbon dioxide, water etc in relation to any hazardous materials for example those regulated by ADR (European Agreement concerning the International Carriage of Dangerous Goods by Road). Allows for the representation of the same value in different languages but not multiple values.
Attribute	fireFighterProtectiveEquipmentDescription	Description1000	0..*	A description of any equipment recommended to be used by fire fighters for protection for example scuba gear, bunker gear, protective equipment in relation to any hazardous materials for example those regulated by ADR (European Agreement concerning the International Carriage of Dangerous Goods by Road). Allows for the representation of the same value in different languages but not multiple values.
Attribute	flammablePropertiesDescription	Description1000	0..*	A description of any properties related to the ability of a substance to catch fire for example auto-ignition temperature, flashpoint, LEL, UEL in relation to any hazardous materials for example those regulated by ADR (European Agreement concerning the International Carriage of Dangerous Goods by Road).

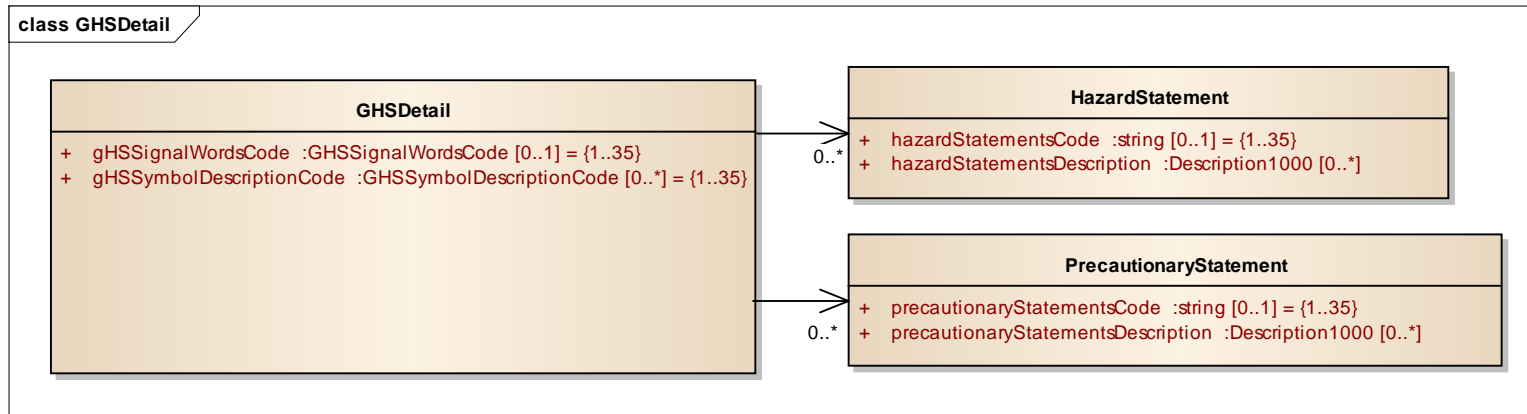

content	attribute / role	datatype /secondary class	multiplicity	definition
GHSDetail				Details related to the Globally Harmonized System of Classification and Labelling of Chemicals.
Association		HazardStatement	0..*	Standard phrases describing the nature of a hazard per GHS. Recommend to use GHS Fifth Revised Edition.
Association		PrecautionaryStatement	0..*	Measures listed on a hazardous label to minimize or prevent adverse effects related to GHS. Recommend to use GHS Fifth Revised Edition.
Attribute	gHSSignalWordsCode	GHSSignalWordsCode	0..1	Words such as "Danger" or "Warning" used to emphasize hazards and indicate the relative level of severity of the hazard. For GHS these are assigned to a GHS hazard class and category. Some lower level hazard categories do not use signal words.
Attribute	gHSSymbolDescriptionCode	GHSSymbolDescriptionCode	0..*	A code depicting the symbols which convey health, physical and environmental hazard information, assigned to a hazard class and category for example GHS. Pictograms include the harmonized hazard symbols plus other graphic elements, such as borders, background patterns or colours that are intended to convey specific information. Examples of all the pictograms and downloadable files for GHS can be accessed on the UN website for the GHS.

content	attribute / role	datatype /secondary class	multiplicity	definition
HazardStatement				Standard phrases describing the nature of a hazard per GHS.
Attribute	hazardStatementCode	string	0..1	Standard phrases assigned to a hazard class and category that describe the nature of the hazard for example H200.
Attribute	hazardStatementDescription	Description1000	0..*	A description of standard phrases assigned to a hazard class and category that describe the nature of the hazard.
PrecautionaryStatement				Measures listed on a hazardous label to minimize or prevent adverse effects related to GHS.
Attribute	precautionaryStatementsCode	string	0..1	Measures listed on a hazardous label to minimize or prevent adverse effects. For GHS, the precautionary statements have been linked to each GHS hazard statement and type of hazard. Precautionary statements for GHS cover prevention, response in cases of accidental spillage or exposure, storage, and disposal..
Attribute	precautionaryStatementsDescription	Description1000	0..*	A description of the measures listed on a hazardous label to minimize or prevent adverse effects.

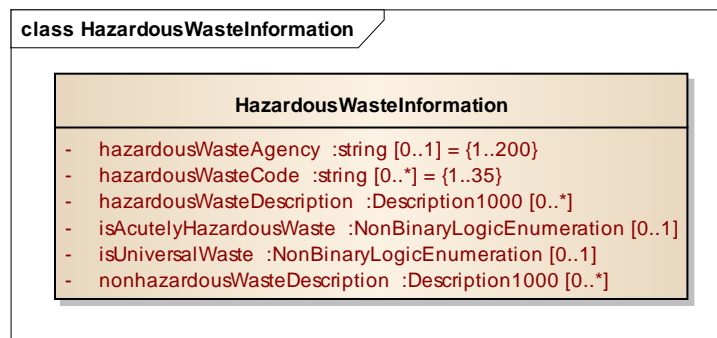

content	attribute / role	datatype /secondary class	multiplicity	definition
HazardousWasteInformation				Information on the hazardous waste classification for a trade item.
Attribute	hazardousWasteAgency	string	0..1	The Agency for the Classification of Hazardous Waste. The specific hazardous waste code for the federal or state regulation that applies to the product for example US EPA.

content	attribute / role	datatype /secondary class	multiplicity	definition
Attribute	hazardousWasteCode	string	0..*	A classification of hazardous waste managed at the federal or state level for example EPA Hazardous Waste Code of D001 (Ignitable waste).
Attribute	hazardousWasteDescription	Description1000	0..*	A description of the classification of hazardous waste managed at the federal or state level for example EPA Hazardous Waste Code of D001 (Ignitable waste).
Attribute	isAcutelyHazardousWaste	NonBinaryLogicEnumeration	0..1	An indicator whether or not the Trade Item contains wastes that would cause death, disabling personal injury, or serious illness. These wastes are more hazardous than ordinary hazardous wastes.
Attribute	isUniversalWaste	NonBinaryLogicEnumeration	0..1	Indicates if a product can be considered universal waste. Universal waste is defined as "are wastes that do not meet the regulatory definition of hazardous waste, but are managed under special, tailored regulations"
Attribute	nonHazardousWasteDescription	Description1000	0..*	A classification of non-hazardous waste managed at the federal or state level for example a code for disposal of latex paint.

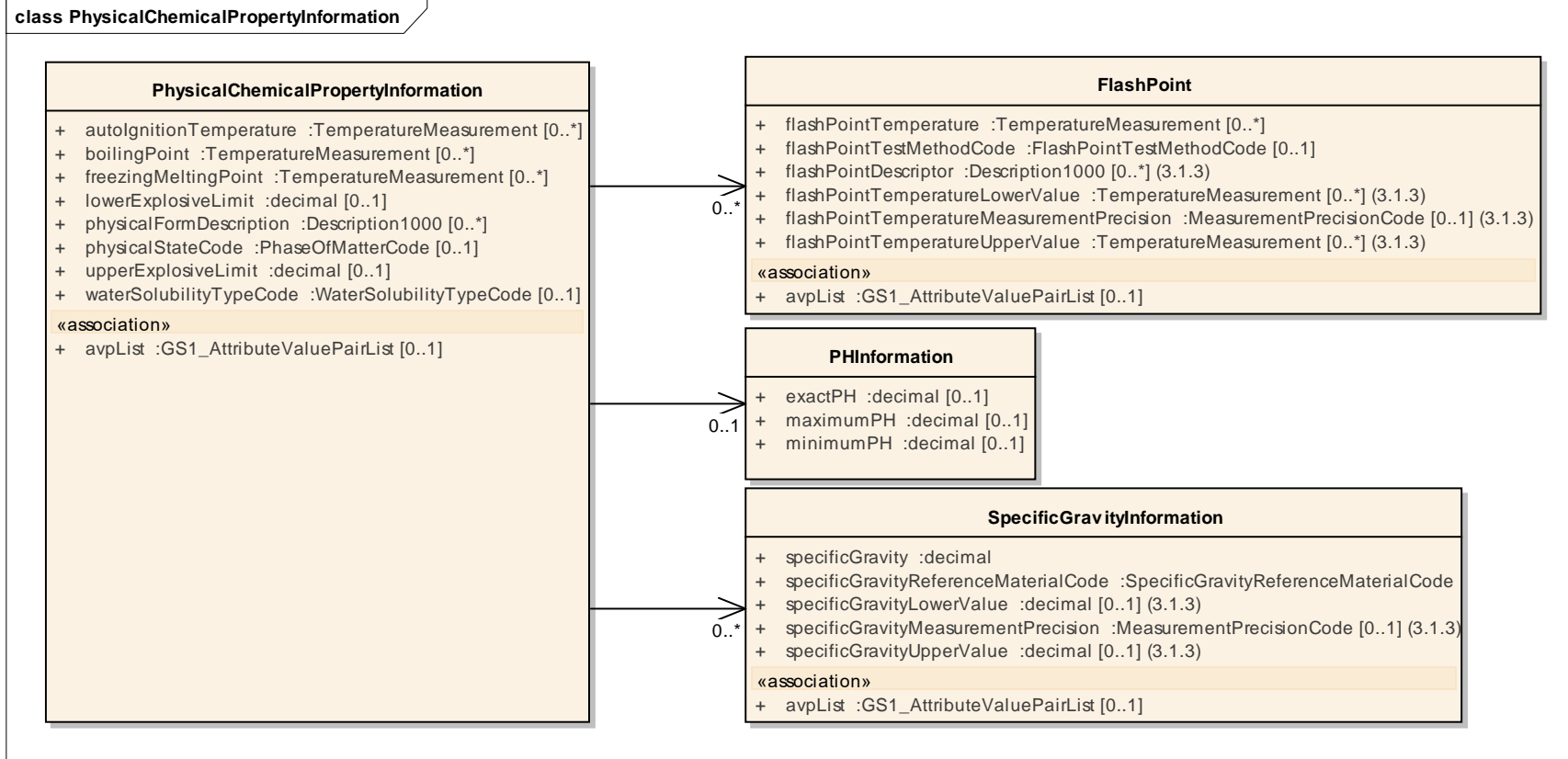

content	attribute / role	datatype /secondary class	multiplicity	definition
PHInformation				PH is defined as the acidity or alkalinity of an aqueous solution. It is defined as the logarithm of the reciprocal of the hydrogenion concentration of a solution. $pH = \log_{10} 1/[H^+]$.
Attribute	exactPH	Decimal	0..1	The exact PH amount for a chemical ingredient (not a range).
Attribute	maximumPH	Decimal	0..1	The maximum range for PH.
Attribute	minimumPH	Decimal	0..1	The minimum range value for PH.

content	attribute / role	datatype /secondary class	multiplicity	definition
PhysicalChemicalPropertyInformation				Information on Physical or Chemical Properties for a trade item for example water solubility.
Association		PHInformation	0..1	PH is defined as the acidity or alkalinity of an aqueous solution. It is defined as the logarithm of the reciprocal of the hydrogenion concentration of a solution. $pH = \log_{10} 1/[H^+]$.
Association		Flashpoint	0..*	Details on the flash point for a trade item.
Association		SpecificGravityInformation	0..*	Specific Gravity Information for a trade item.
Attribute	autoIgnitionTemperature	TemperatureMeasurement	0..*	The lowest temperature at which it will spontaneously ignite in a normal atmosphere without an external source of ignition
Attribute	boilingPoint	TemperatureMeasurement	0..*	The temperature of a liquid at which its vapour pressure is equal to or very slightly greater than the atmospheric pressure of the environment. Note: (For water at sea level it is 100°C (212°F)).
Attribute	freezingMeltingPoint	TemperatureMeasurement	0..*	The temperature at which its crystals are in equilibrium with the liquid phase at atmospheric pressure.
Attribute	lowerExplosiveLimit	Decimal	0..1	The low end value expressed as a percent by volume that the mixture is still flammable.
Attribute	physicalFormDescription	Description1000	0..*	A description of the form of the product for example gas, liquid, powder. Colorless, Fragrant, Liquid in relation to any hazardous materials.
Attribute	physicalStateCode	PhaseOfMatterCode	0..1	Any physical state a chemical ingredient may be in for example LIQUID.
Attribute	upperExplosiveLimit	Decimal	0..1	The high end value expressed as a percent by volume that the product will still explode.
Attribute	waterSolubilityTypeCode	WaterSolubilityTypeCode	0..1	Water solubility is defined as a code indicating solubility in respect to water. Solubility is the ability of a given substance to dissolve in a solvent.
Association	avpList	GS1_AttributeValuePairList	0..1	Attribute value pair information.
FlashPoint				Details on the lowest temperature at which a substance gives off a sufficient vapor to support combustion.

content	attribute / role	datatype /secondary class	multiplicity	definition
Attribute	flashPointTemperature	TemperatureMeasurement	0..*	The temperature at which a substance gives off a sufficient vapour to support combustion. This uses a measurement consisting of a unit of measure and value. The flash point is not the lowest point but the point at which flash point occurs and it could be that temperature is lower for some products. The scientific Measurement Precision code would determine that.
Attribute	flashPointTestMethodCode	FlashPointTestMethodCode	0..1	The test method used to determine the flash point temperature for example closed cup.
Attribute	flashPointDescriptor	Description1000	0..*	A descriptor that informs which action the trade item must be used under to achieve that flash point for example when dispensed.
Attribute	flashPointTemperatureLowerValue	TemperatureMeasurement	0..*	A lower value of a possible range of flash point temperatures.
Attribute	flashPointTemperatureMeasurementPrecision	MeasurementPrecisionCode	0..1	The measurement precision used for calculating a flash point temperature for example EXACT.
Attribute	flashPointTemperatureUpperValue	TemperatureMeasurement	0..*	A upper value of a possible range of flash point temperatures.
Association	avpList	GS1_AttributeValuePairList	0..1	Attribute value pair information.
SpecificGravity Information				Specific Gravity is defined as the ratio of the density of a substance to the density of a reference substance. It is an abstract number that is unrelated to any units.
Attribute	specificGravity	Decimal	1..1	Specific Gravity is defined as the ratio of the density of a substance to the density of a reference substance expressed as a float. It is an abstract number that is unrelated to any units.
Attribute	specificGravityReferenceMaterialCode	SpecificGravityReferenceMaterialCode	1..1	The reference material used within the ratio for specific gravity for example water or air.
Attribute	specificGravityLowerValue	decimal	0..1	The lower value in a range of specific gravity.
Attribute	specificGravityMeasurementPrecision	MeasurementPrecisionCode	0..1	The measurement precision used for the specific gravity for example EXACT.
Attribute	specificGravityUpperValue	decimal	0..1	The upper value in a range of specific gravity.
Association	avpList	GS1_AttributeValuePairList	0..1	Attribute value pair information.

class ProtectiveEquipment

```

ProtectiveEquipment
+ protectiveEquipmentAdditionalDescription :Description1000 [0..*]
+ protectiveEquipmentBodyAreaCode :ProtectiveEquipmentBodyAreaCode [0..*]
+ protectiveEquipment :Description1000 [0..*]
+ protectiveEquipmentStatusCode :RecommendedStatusCode [0..1]
  
```

content	attribute / role	datatype /secondary class	multiplicity	definition
ProtectiveEquipment				Information on any recommended protective equipment.
Attribute	protectiveEquipmentAdditionalDescription	Description1000	0..*	Additional information regarding when protective equipment is recommended or required.
Attribute	protectiveEquipment	Description1000	0..*	The manufacturer recommended protective equipment for example protective clothing, helmets, goggles, or other garment designed to protect the wearer's body from chemical exposure.
Attribute	protectiveEquipmentStatusCode	RecommendedStatusCode	0..1	A code determining whether the protective equipment is recommended or required.
Attribute	ProtectiveEquipmentBodyAreaCode	ProtectiveEquipmentBodyAreaCode	0..*	A code determining the part of the body the protective equipment is meant to protect for example EYE

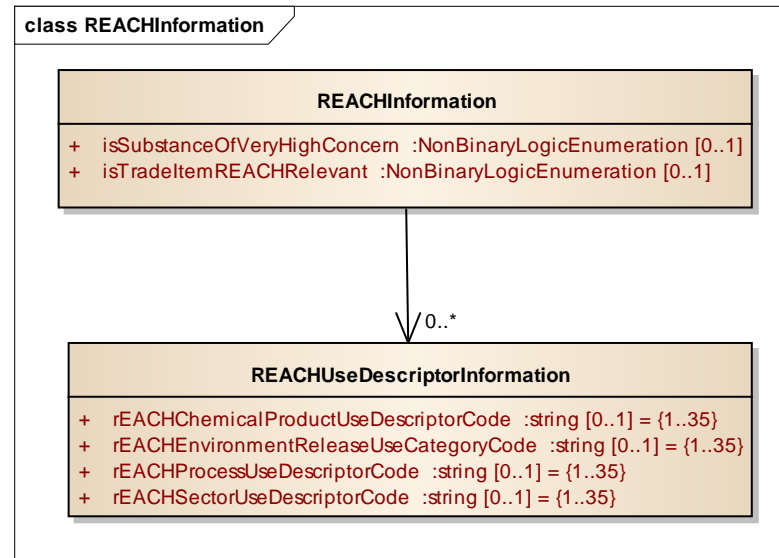

content	attribute / role	datatype / secondary class	multiplicity	definition
REACHInformation				Information on the Directive on the restriction of the use of certain hazardous substances in electrical and electronic equipment.
Association		REACHUseDescriptor Information	0..*	Details on the trade item in relation to REACH (Registration, Evaluation, Authorisation and Restriction of Chemicals). REACH is a European Union Regulation addressing the production and use of chemical substances and their potential impacts on both human health and the environment.

content	attribute / role	datatype /secondary class	multiplicity	definition
Attribute	isSubstanceOfVeryHighConcern	NonBinaryLogicEnumeration	0..1	<p>An indicator that a trade item contains substances of very high concern (SVHC) according to REACH as defined in as defined in Article 57 of Regulation (EC) No 1907/2006. This indication does not mean the contained substance or substances have been added to the REACH Candidate List. Substances of very high concern (SVHC) are defined as:</p> <ul style="list-style-type: none"> •Substances that are category 1 and 2 carcinogens, mutagens or toxic to the reproductive system (CMR) •Substances that are persistent, bio-accumulative and toxic (PBT) or very persistent and very bio-accumulative (vPvB) •Substances such as endocrine disrupters, which are demonstrated to be of equivalent concern. For these substances, there are specific requirements under the REACH Regulation.
Attribute	isTradeItemREACHRelevant	NonBinaryLogicEnumeration	0..1	An indicator that the trade item may have ingredients that subject it to REACH.
REACHUseDescriptorInformation				Details on the trade item in relation to REACH (Registration, Evaluation, Authorisation and Restriction of Chemicals). REACH is a European Union Regulation addressing the production and use of chemical substances and their potential impacts on both human health and the environment.
Attribute	rEACHChemicalProductUseDescriptorCode	string	0..1	The types of preparations (mixtures) the substance is contained in end-use. An example of a Reach Chemical Product Descriptor is PC1: Adhesives, sealants.
Attribute	rEACHEnvironmentReleaseUseCategoryCode	string	0..1	The broad conditions of use from the environmental perspective. An example of a REACH Environment Release Category is ERC 3 Formulation in materials.
Attribute	rEACHProcessUseDescriptorCode	string	0..1	The technical process or application in which the substance is used from an occupational perspective. An example of a REACH Process Use Descriptor is PROC 7 Industrial Spraying.

content	attribute / role	datatype /secondary class	multiplicity	definition
Attribute	rEACHSectorUseDescriptorCode	string	0..1	The sector of the economy the substance is used. Use includes manufacture in the chemical industry, mixing of substances at formulator's level as well as industrial, professional and consumer end-uses. An example of a REACH Sector Use Descriptor is SU4 Manufacture of food products.

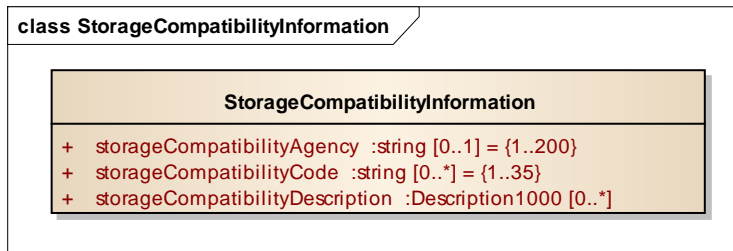

content	attribute / role	datatype /secondary class	multiplicity	definition
StorageCompatibilityInformation				Information on the types of materials that this product cannot be stored with.
Attribute	storageCompatibilityAgency	string	0..1	The agency which maintains a list of storage compatibilities for example NFPA.
Attribute	storageCompatibilityCode	string	0..*	A storage compatibilities expressed as a code.
Attribute	storageCompatibilityDescription	Description1000	0..*	The types of materials that this product cannot be stored with. Incompatible chemicals give an undesired chemical reaction when mixed. This usually refers to substances that will react to cause an imminent threat to health and safety through an explosion, fire, and/or formation of toxic materials.

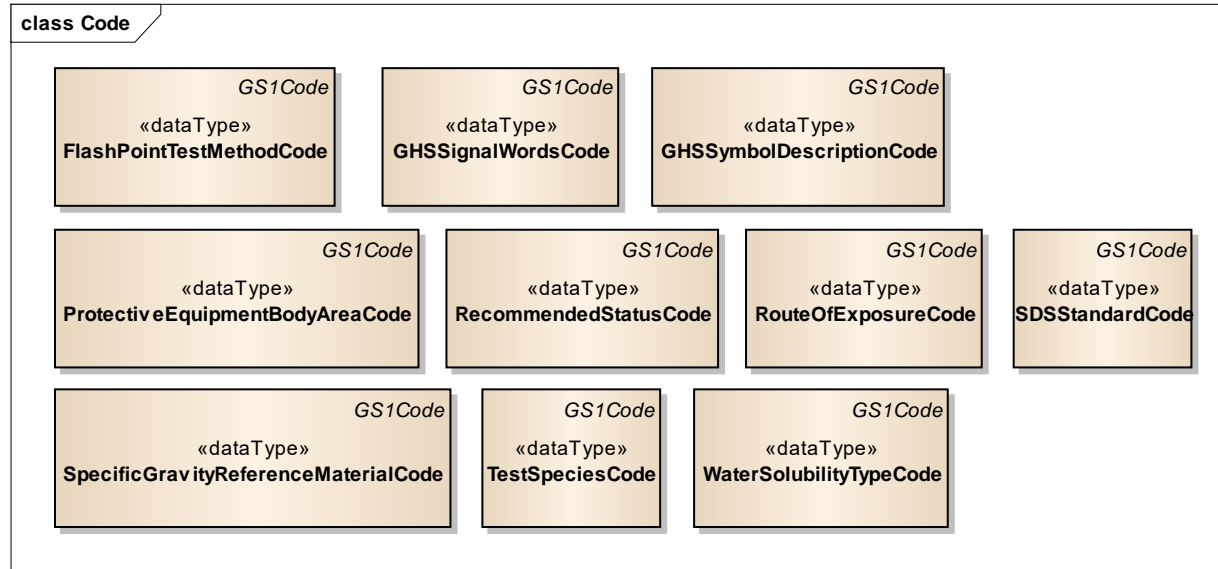

5.58 Sales Information Module

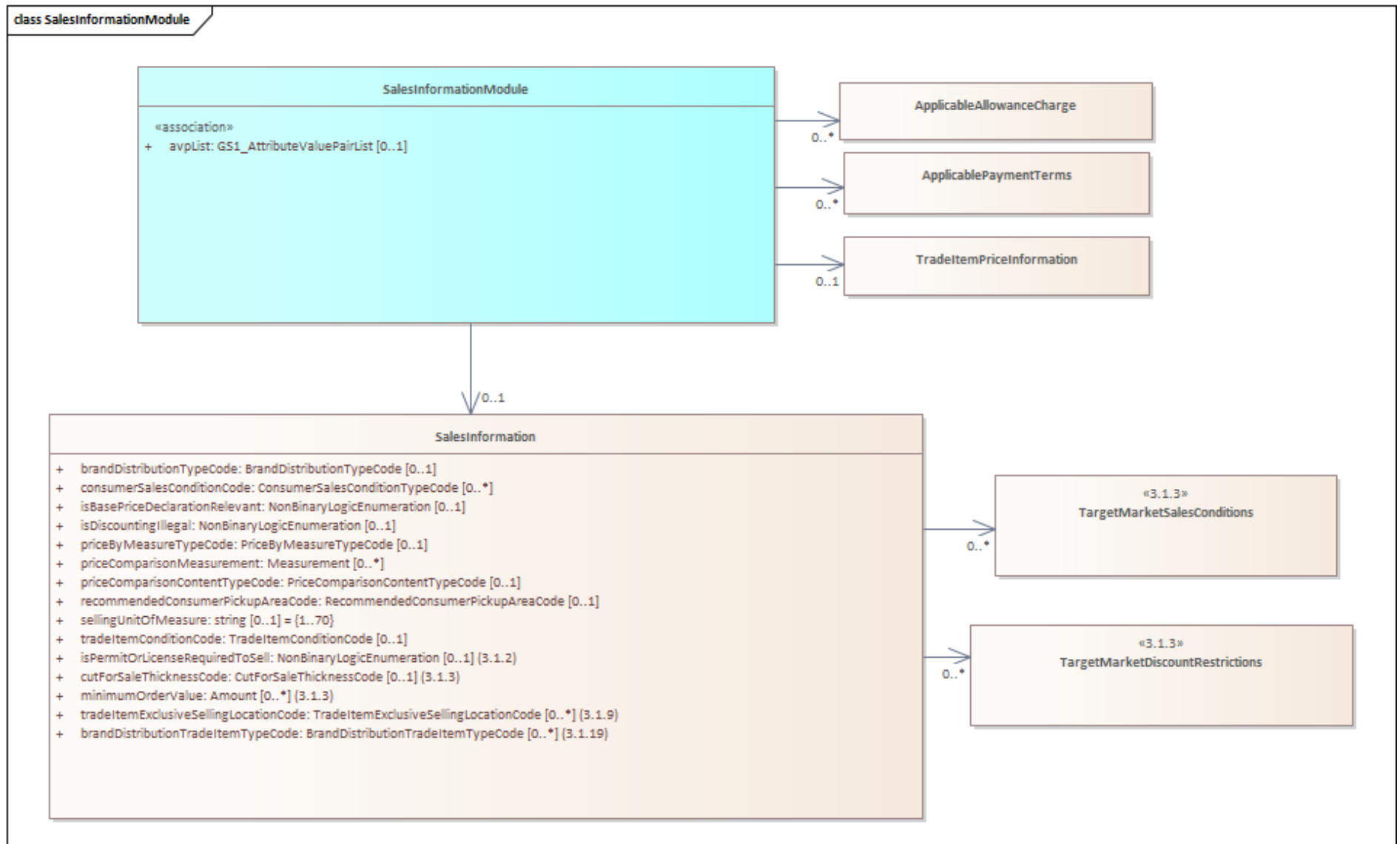

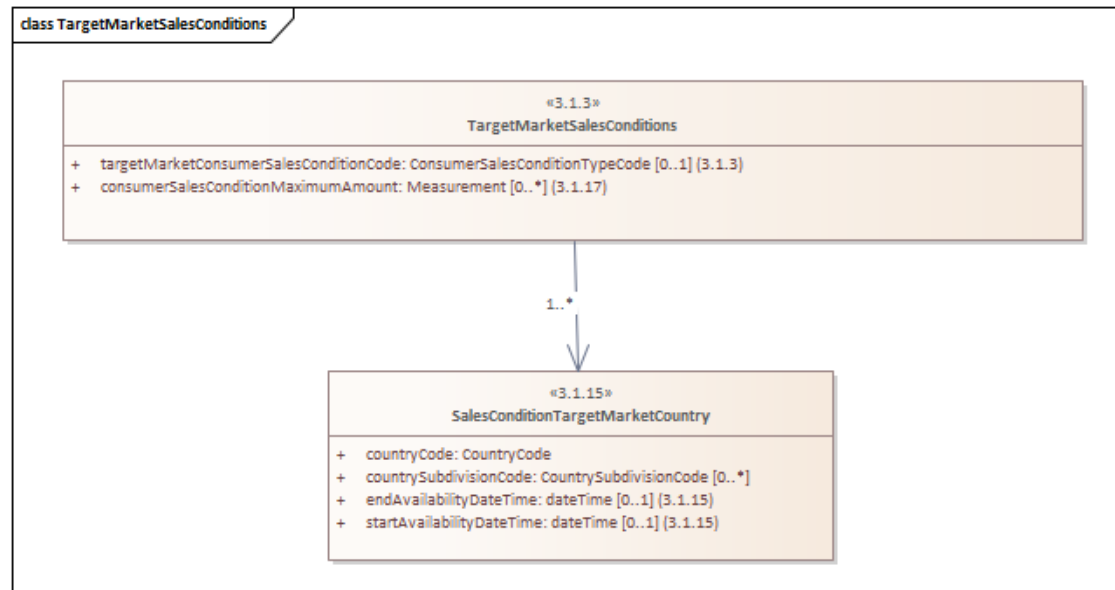
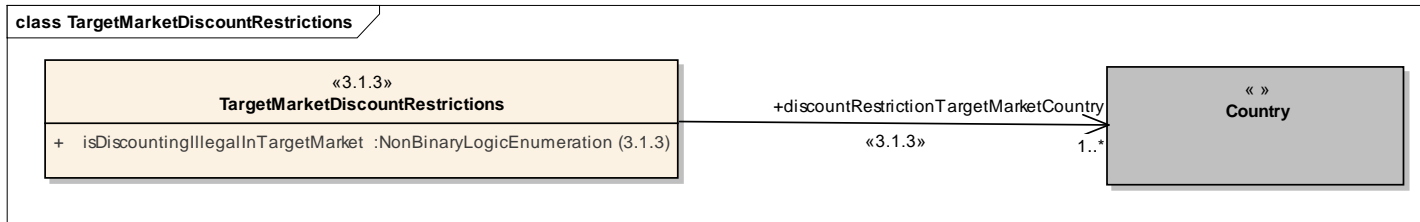

content	attribute / role	datatype /secondary class	multipl city	definition
SalesInformation				Restrictions or requirements on the retailer for sales of the Trade Item to the consumer.
Attribute	brandDistributionType Code	BrandDistributionT ypeCode	0..1	Any restrictions imposed on the Trade Item on how it can be sold to the consumer or recipient trading partner.

content	attribute / role	datatype /secondary class	multiplcity	definition
Attribute	consumerSalesConditionCode	ConsumerSalesConditionTypeCode	0..*	A code depicting restrictions imposed on the Trade Item regarding how it can be sold to the consumer for example age restrictions, selling restrictions.
Attribute	isBasePriceDeclarationRelevant	NonBinaryLogicEnumeration	0..1	An indicator whether this item is mandated to have price comparison information included according to country specific pricing directives.
Attribute	isDiscountingIllegal	NonBinaryLogicEnumeration	0..1	An indicator whether or not the product is not legal to discount within a given target market (i.e. the product is subject to government regulation regarding either price floors or pricing practices).
Attribute	isPermitOrLicenseRequiredToSell	NonBinaryLogicEnumeration	0..1	Indicates if the recipient needs a permit or license to sell the product to consumer.
Attribute	priceByMeasureTypeCode	PriceByMeasureTypeCode	0..1	Indicator to show how a product is sold.
Attribute	priceComparisonMeasurement	Measurement	0..*	The quantity of the product at usage. Applicable for concentrated products and products where the comparison price is calculated based on a measurement other than netContent. This field is dependent on the population of priceComparisonContentType and is required when priceComparisonContentType is used.
Attribute	priceComparisonContentTypeCode	PriceComparisonContentTypeCode	0..1	Code indicating how the value in Price Comparison Measurement is used to calculate the comparative price, which is printed on shelf labels.
Attribute	recommendedConsumerPickupAreaCode	RecommendedConsumerPickupAreaCode	0..1	The recommended placement for the consumer purchase decision point of the item and location within the retail store . For example a potato salad bulk my need to be portioned to a consumer at a service counter as the purchase amount is dependent on what the consumer would like to purchase.
Attribute	sellingUnitOfMeasure	string	0..1	Describes the measurement used for selling unit of the Trade Item to the end consumer. A Trade Item may have only one Unit of Measure.
Attribute	tradeItemConditionCode	TradeItemConditionCode	0..1	The code depicting the type of preparation that a trade item may require before being sold to the consumer (e.g. cut for sale, portioned/pieced). This preparation should be done by the buyer.

content	attribute / role	datatype /secondary class	multiplcity	definition
Attribute	cutForSaleThicknessCode	CutForSaleThicknessCode	0..1	A code describing the cut for items for sale for example THICK. For presentation and shelf planning, the thickness in general terms of the slice are important.
Attribute	minimumOrderValue	Amount	0..*	The minimum order value of the trade item expressed in a money amount that can be ordered. This attribute is to be used with a respective currency (e.g. 1000.00 USD).
Attribute	tradeItemExclusiveSellingLocationCode	TradeItemExclusiveSellingLocationCode	0..*	A code Identifying the kind of selling location(s) in which the product can be sold for example BOAT . This can apply to both physical and digital locations.
Attribute	brandDistributionTradeItemTypeCode	BrandDistributionTradeItemTypeCode	0..*	Categorization of the trade item to help further delineate product type with distribution type and trade channel. For example: Bulk, Private label, and Custom Label.
Association		TargetMarketSalesConditions	0..*	Sales conditions that apply to a specific target market.
Association		TargetMarketDiscountRestrictions	0..*	Discount restrictions that apply to a specific target market.
SalesInformationModule				Sales information regarding price and selling conditions/restrictions of the Trade Item to the consumer.
Association		ApplicableAllowanceCharge	0..*	Specifies allowances and charges applicable to a trade item.
Association		ApplicablePaymentTerms	0..*	Payment terms and conditions by which a payment can be made for a trade item.
Association		SalesInformation	0..1	Restrictions or requirements on the retailer for sales of the Trade Item to the consumer.
Association		TradeItemPriceInformation	0..1	Provides Price details including effective dates.
Association	avpList	GS1_AttributeValuePairList	0..1	Attribute value pair information.
TargetMarketDiscountRestrictions				Determines whether an item requires a license or permit to sell within a specific target market.
Association	discountRestrictionTargetMarketCountry	Country	1..*	The target market that any restrictions on a discount applies to.
Attribute	isDiscountingIllegalInTargetMarket	NonBinaryLogicEnumeration	1..1	An indicator whether or not the product is not legal to discount within a given target market (i.e. the product is subject to government regulation regarding either price floors or pricing practices).
TargetMarketSalesConditions				Sales conditions which can differ based upon a target market.

content	attribute / role	datatype /secondary class	multiplcity	definition
Attribute	consumerSalesConditionMaximumAmount	Measurement	0..*	The maximum amount of the trade item that can be sold to the consumer at POS (Point Of Sale). This amount may be regulated by law in some markets.
Attribute	targetMarketConsumerSalesConditionCode	ConsumerSalesConditionTypeCode	0..1	A code depicting restrictions imposed on the Trade Item regarding how it can be sold to the consumer for example age restrictions, selling restrictions.
SalesConditionTargetMarketCountry				Sales conditions which can differ based upon a target market or country.
Attribute	countryCode	CountryCode	1..1	The country in which a processing or other activity has been performed for example processing, bottling, manufacturing.
Attribute	countrySubdivisionCode	CountrySubdivisionCode	0..*	The country subdivision in which a processing or other activity has been performed for example processing, bottling, manufacturing.
Attribute	endAvailabilityDateTime	DateTime	0..1	The date from which the trade item is no longer available from the information provider, including seasonal or temporary trade item and services.
Attribute	startAvailabilityDateTime	DateTime	0..1	The date from which the trade item becomes available from the supplier, including seasonal or temporary trade item and services.

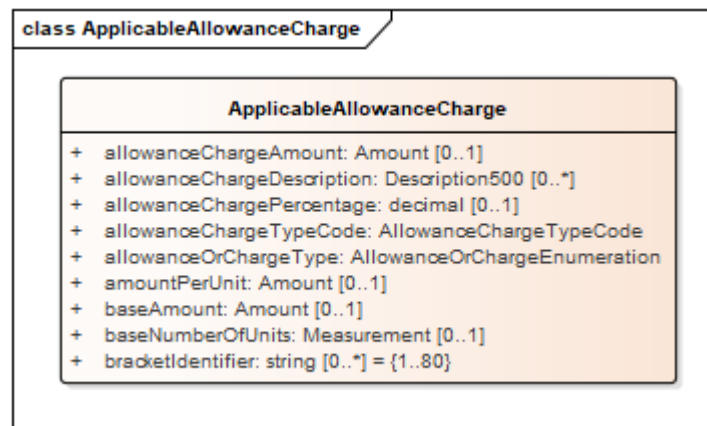

content	attribute / role	datatype /secondary class	multiplcity	definition
ApplicableAllowanceCharge				Specifies allowances and charges applicable to a trade item.
Attribute	AllowanceChargeTypeCode	allowanceChargeTypeCode	1..1	The identification of an allowance charge selected from a predefined list.
Attribute	AllowanceOrChargeType	allowanceOrChargeTypeEnumeration	1..1	Code specifying whether this is an allowance or a charge.
Attribute	allowanceChargeAmount	Amount	0..1	Amount of allowance or charge applicable.
Attribute	allowanceChargeDescription	Description500	0..*	A text explanation of the allowance or charge.
Attribute	allowanceChargePercentage	Decimal	0..1	Allowance and charges can be expressed in different ways. By using percentage, they are expressed as a percentage of another amount, e.g. the base amount.
Attribute	amountPerUnit	Amount	0..1	Allowance/charge per unit expressed as an amount.
Attribute	baseAmount	Amount	0..1	The amount on which the calculation of the allowance or charge is based.
Attribute	baseNumberOfUnits	Measurement	0..1	Number of units on which the allowance or charge is based.
Attribute	bracketIdentifier	String	0..*	Identification of the conditions that apply to the allowance or charge.

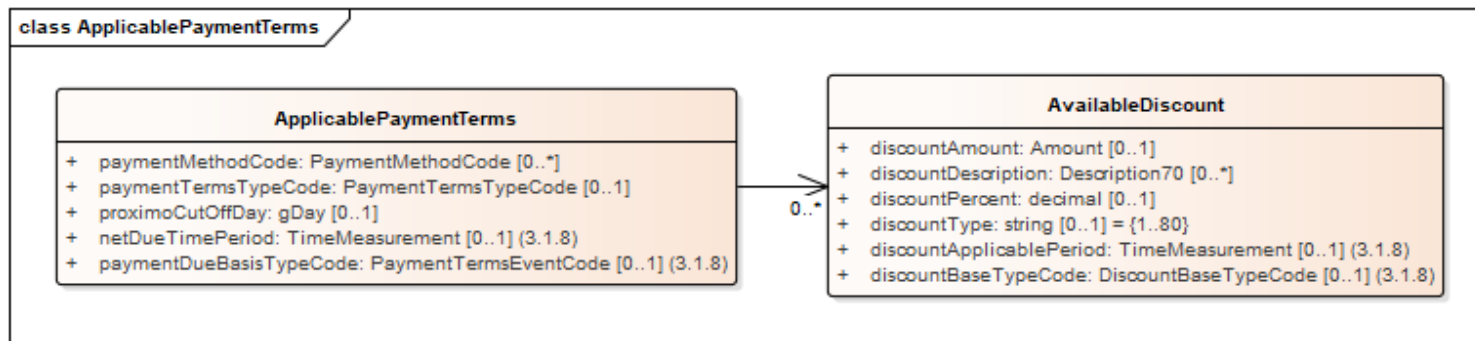

content	attribute / role	datatype /secondary class	multiplcity	definition
ApplicablePaymentTerms				Payment terms and conditions by which a payment can be made for a trade item.
Association		AvailableDiscount	0..*	Additional information on discounts that may be applied to the payment depending on the way the payment is being made for example "2 percent in 10 days, net 30".
Attribute	netDueTimePeriod	TimeMeasurement	0..1	Time period amount should be paid. For example: 30 DAY
Attribute	paymentDueBasisTypeCode	PaymentTermsEventCode	0..1	The basis type on which the payment is due. For example, RECEIPT_OF_GOODS.
Attribute	paymentMethodCode	PaymentMethodCode	0..*	The payment method used in the payment terms.
Attribute	paymentTermsTypeCode	PaymentTermsTypeCode	0..1	The type of payment term expressed as a code for example DISCOUNT.
Attribute	proximoCutOffDay	gDay	0..1	The day of the month the payment becomes due.
AvailableDiscount				Information on a discount specified in a payment term. Information on discounts that may be applied to the payment depending on the way the payment is being made for example "2 percent in 10 days, net 30".
Attribute	discountAmount	amount	0..1	The deduction represented as an amount .
Attribute	discountApplicablePeriod	TimeMeasurement	0..1	Time period the discount is applicable.
Attribute	discountBaseTypeCode	DiscountBaseTypeCode	0..1	Describes the price base applicable to the discount. For example NET or GROSS.
Attribute	discountDescription	Description70	0..*	A text field describing the discount.
Attribute	discountPercent	decimal	0..1	The deduction represented as a percentage.
Attribute	discountType	string	0..1	A string value that specifies the type of payment discount for example "2 percent in 10 days, net 30".

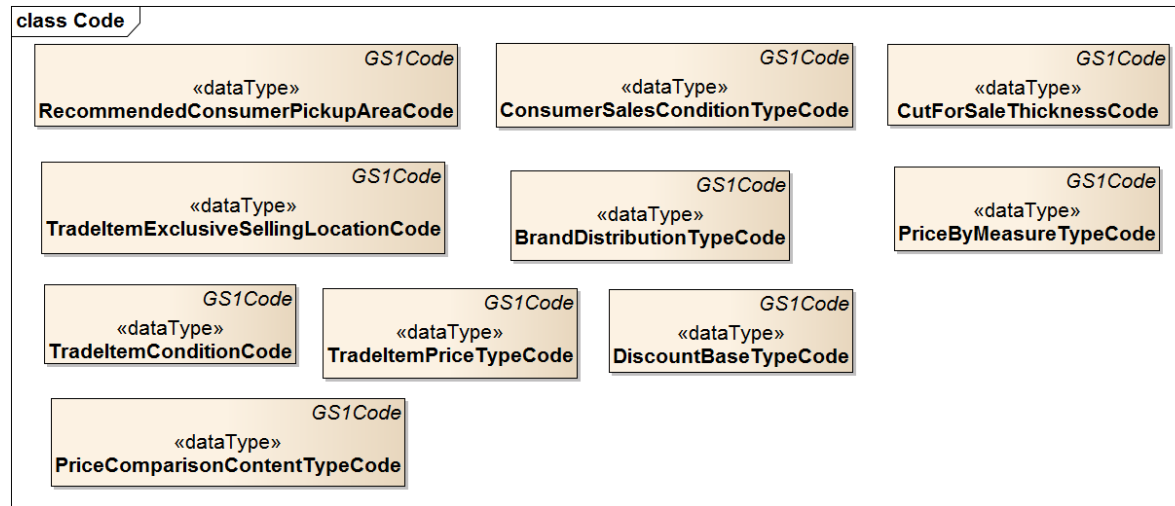
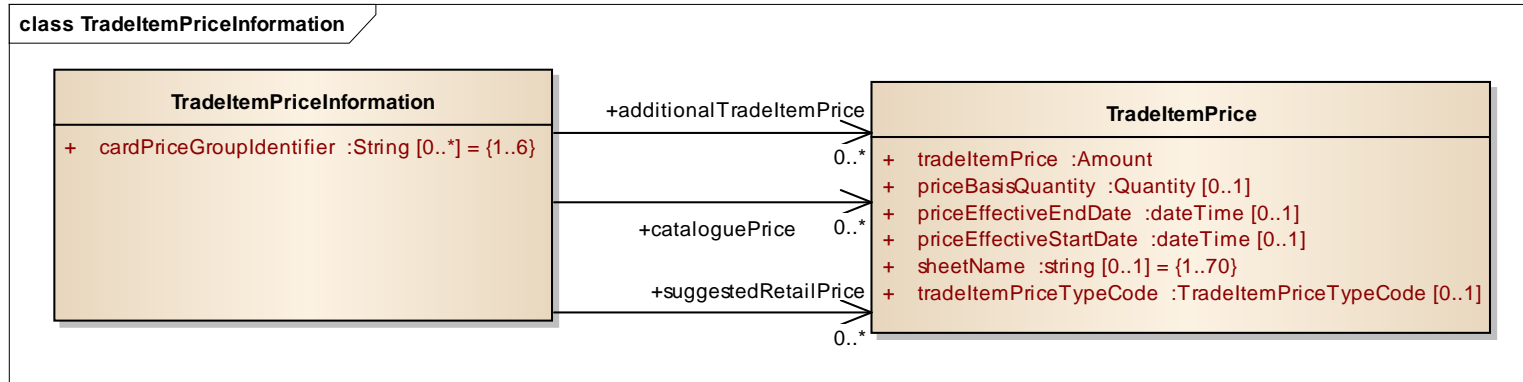

content	attribute / role	datatype /secondary class	multipl city	definition
TradeItemPrice				Provides Price details including effective dates.
Attribute	tradeItemPrice	Amount	1..1	Provides the trade item price value.
Attribute	priceBasisQuantity	quantity	0..1	The price basis quantity is the associated quantity of trade item for which a price is given.

content	attribute / role	datatype /secondary class	multiplcity	definition
Attribute	priceEffectiveEndDate	dateTime	0..1	The effective end date of the price is optional based upon the agreement by the trading partners. If an invalid end date is communicated, then it is implied that the price and its effective date are effective until further notice. Examples of invalid dates include 99/99/9999, 00/00/0000, blank, etc. These invalid end dates should not be communicated. Various types of dates may be pre-aligned between buyer and seller. For example, based upon a prior agreement between trading partners this date may relate to any of the following events, last order date, last ship date, and last arrival date.
Attribute	priceEffectiveStartDate	dateTime	0..1	This is the effective start date of the price agreed to by the trading partners. This start date is mandatory and, if no end date is communicated, then implies that the price is effective until further notice. Various types of dates may be pre-aligned between buyer and seller. For example, based upon a prior agreement between trading partners this date may relate to any of the following events, first order date, first ship date, and first arrival date.
Attribute	sheetName	string	0..1	The Price Sheet to which a price belongs. A price list is a list of prices of goods and services which are to be used or supplied during a period of time.
Attribute	tradeItemPriceTypeCode	TradeItemPriceTypeCode	0..1	The type of price for the item for example bulk price.
TradeItemPriceInformation				Provides Price details including effective dates.
Association	additionalTradeItemPrice	TradeItemPrice	0..*	Provides Price details including effective dates.
Association	cataloguePrice	TradeItemPrice	0..*	The gross price before application of any discounts, allowances, charges, taxes, etcetera. The value represented is the price that the manufacturer expects to receive for the trade item or service from any buyer prior to any relationship specific negotiations (E.g. a public catalogue population).
Association	suggestedRetailPrice	TradeItemPrice	0..*	The retail (to consumer) price as suggested by the manufacturer. This is normally used to establish a proposed value for the trade item for marketing purposes. May or may not appear on the package.

content	attribute / role	datatype /secondary class	multiplcity	definition
Attribute	cardPriceGroupIdentifier	string	0..*	A code that identifies a price.

5.59 Security Tag Information Module

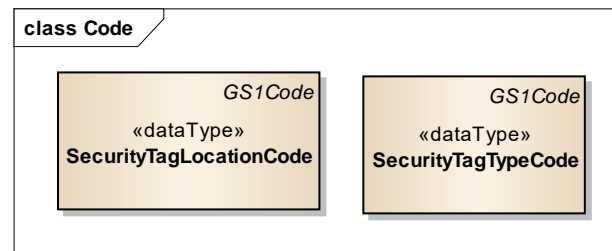
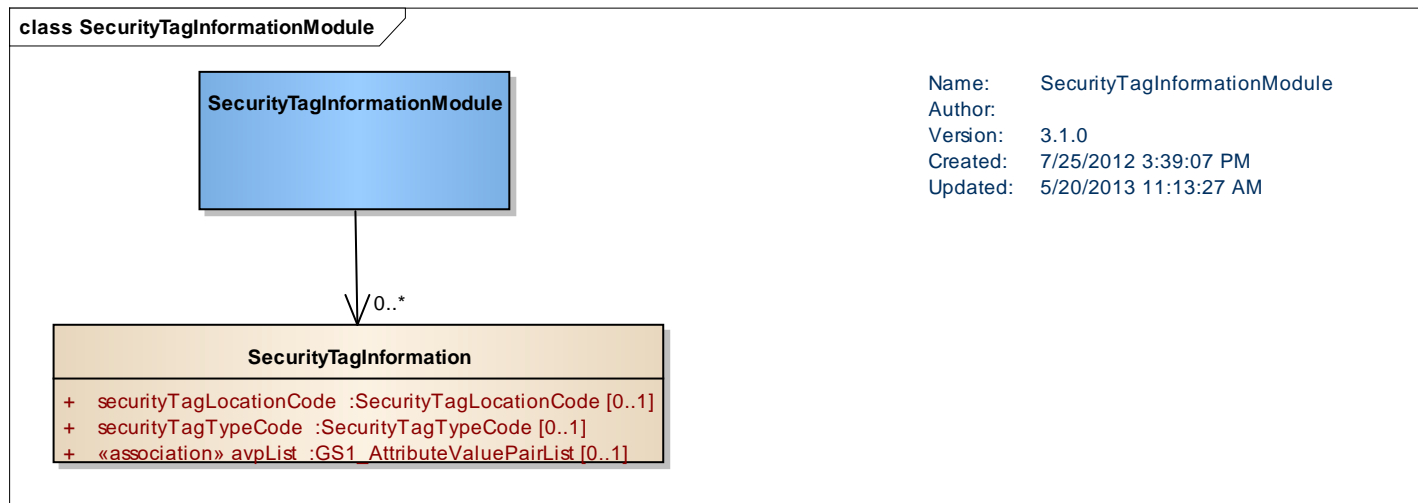

content	attribute / role	datatype /secondary class	multiplicity	definition
SecurityTagInformation				Information on any security tags that may come with the trade item.

content	attribute / role	datatype /secondary class	multiplicity	definition
Association	avpList	GS1_AttributeValuePairList	0..1	Attribute value pair information.
Attribute	securityTagLocationCode	SecurityTagLocationCode	0..1	This is a code to indicate where the EAS tag is located on the Trade Item. Values include On outside of Trade Item, Concealed inside Trade Item, Integrated Inside Trade Item.
Attribute	securityTagTypeCode	SecurityTagTypeCode	0..1	This is a code to indicate the type of EAS tag located on the Trade Item. Values include Acousto-Magnetic, Electro-Magnetic, Ink or dye, Microwave, Radio Frequency.
SecurityTagInformationModule				Information on any security tags that may come with the trade item.
Association		SecurityTagInformation	0..*	Information on any security tags that may come with the trade item.

5.60 Software System Requirements Module

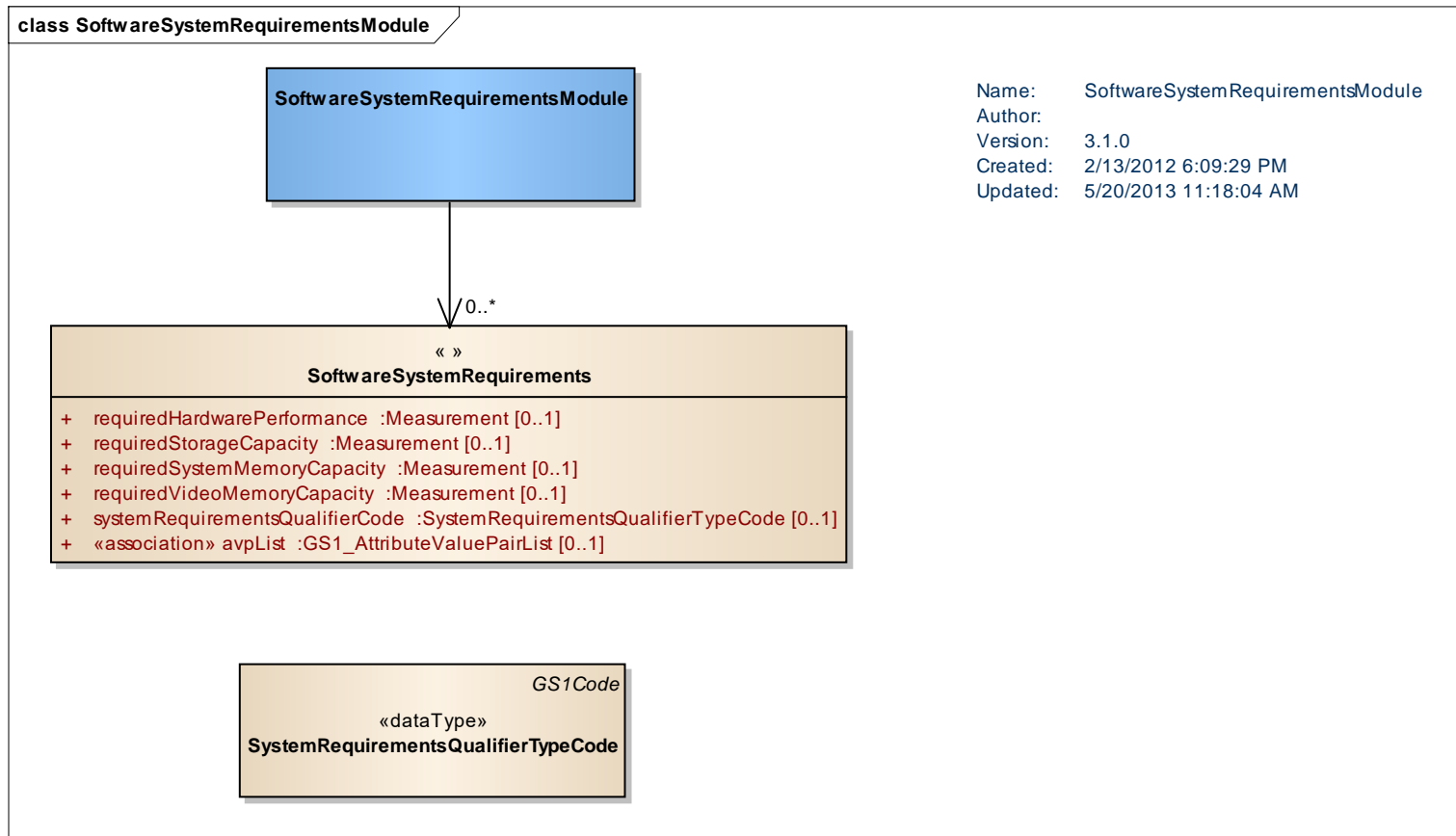

Content	Attribute / Role	Datatype /Secondary class	Multiplicity	Definition
SoftwareSystemRequirementsModule				A Module with details on any required or recommended system 363ilename363can to run the software.
Association		SoftwareSystemRequirements	0..*	Details on any required or recommended system 363ilename363can to run the software.
SoftwareSystemRequirements				Details on any required or recommended system 363ilename363can to run the software.



Content	Attribute / Role	Datatype /Secondary class	Multiplicity	Definition
Association	avpList	GS1_AttributeValuePairList	0..1	Attribute value pair information.
Attribute	requiredHardwarePerformance	Measurement	0..1	The hardware performance required of the system to operate the software defined by the fundamental rate in cycles per second measured in hertz.
Attribute	requiredStorageCapacity	Measurement	0..1	The required data storage capacity required of the system to store the software.
Attribute	requiredSystemMemoryCapacity	Measurement	0..1	The temporary system memory capacity required of the system to run the software.
Attribute	requiredVideoMemoryCapacity	Measurement	0..1	The video memory capacity required of the system to run the software expressed in megabytes. Video memory is memory dedicated to the purpose of holding the information necessary for a graphics card.
Attribute	systemRequirementsQualifierCode	SystemRequirementsQualifierTypeCode	0..1	A code that determines the type of system performance requirements for example minimum or recommended.



5.61 Sustainability Module

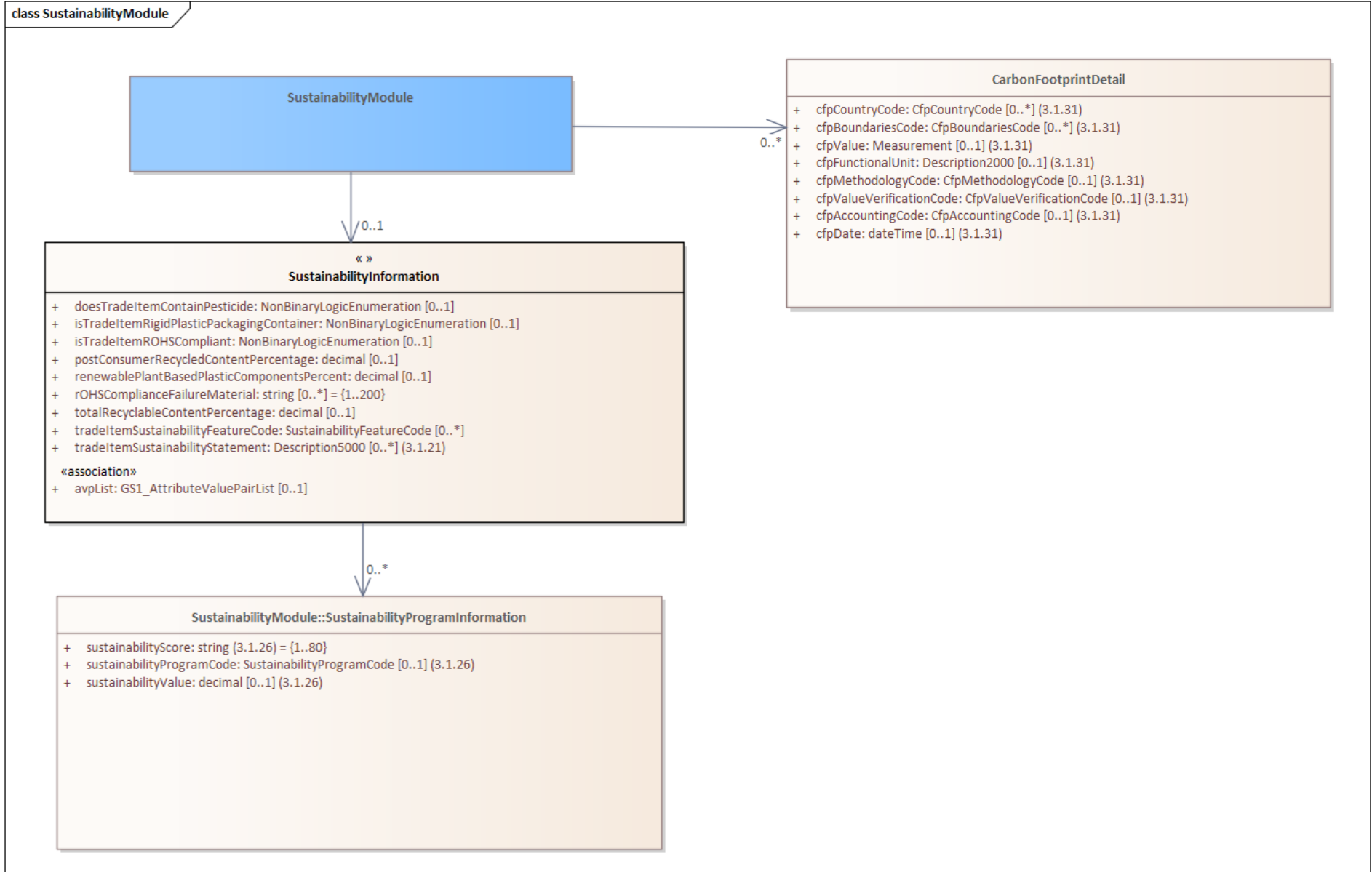

FarmingAndProcessingInformationModule

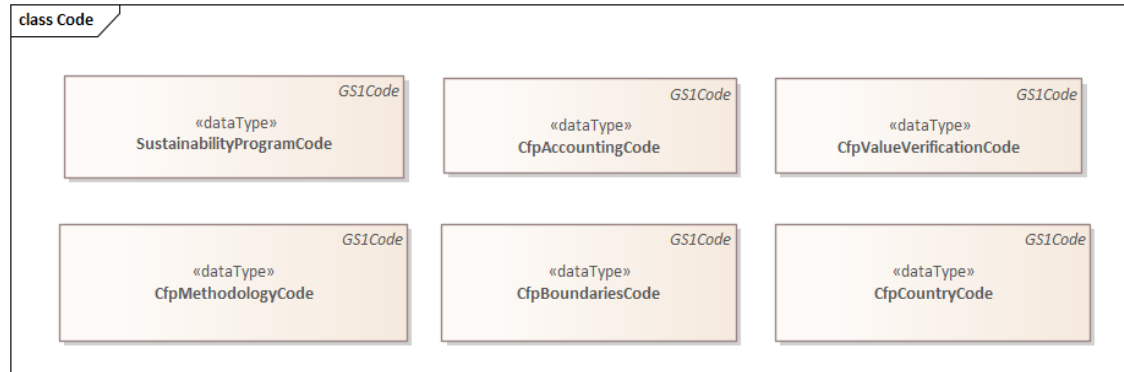

content	attribute / role	datatype /secondary class	multiplcity	definition
SustainabilityInformation				Properties of the trade item that can affect the ecological or human environment.
Association	avpList	GS1_AttributeValuePairList	0..1	Attribute value pair information.
Attribute	doesTradeItemContainPesticide	NonBinaryLogicEnumeration	0..1	Indicates if the trade item is advertised or labelled as a chemical or contains a chemical that is advertised or labelled to kill, repel or prevent the growth of any living organism.
Attribute	isTradeItemRigidPlasticPackagingContainer	NonBinaryLogicEnumeration	0..1	Indicates that a product is or is contained in a Rigid Plastic Packaging Container (RPPC) as defined by laws in the target market. A Rigid Plastic Packaging Container is a container that is made entirely of plastic, with a capacity between 8 fluid ounces and 5 gallons or the equivalent solid volume, maintains its shape while holding the product, and is capable of multiple re-closures.

content	attribute / role	datatype /secondary class	multiplcity	definition
Attribute	isTradeItemROHSCompliant	NonBinaryLogicEnumeration	0..1	Indicates if the product is compliant with the European Union RoHS Directive (the restriction of the use of certain hazardous substances in electrical and electronic equipment), a government regulated agency that sets guidelines for product not to contain certain hazardous substances. The RoHS (restriction of the use of certain hazardous substances) bans the placing on the EU market of new electrical and electronic equipment containing more than agreed levels of lead, cadmium, mercury, hexavalent chromium, polybrominated biphenyl (PBB) and polybrominated diphenyl ether (PBDE) flame retardants.
Attribute	postConsumerRecycledContentPercentage	decimal	0..1	Indicates the percentage of post-consumer material used in the trade item. The post-consumer material is collected from recycle bins and used as pulp to make new items. The percentage of post-consumer material is needed to drive whether the recycled logo goes on the item. Some post-consumer material is collected from the recycle bins and used as pulp to make new items.
Attribute	renewablePlantBasedPlasticComponentsPercentage	decimal	0..1	The percentage of the plastic components only made from rapidly renewable plant-based material by net weight of product (excludes packaging).
Attribute	roHSComplianceFailureMaterial	string	0..*	The material used in the trade item that does not comply with the ROHS Directives. ROHS is the "restriction of the use of certain hazardous substances in electrical and electronic equipment". This Directive bans the placing on the EU market of new electrical and electronic equipment containing more than agreed levels of lead, cadmium, mercury, hexavalent chromium, polybrominated biphenyl (PBB) and polybrominated diphenyl ether (PBDE) flame retardants. Use the ROHSComplianceFailureMaterialCode.
Attribute	totalRecyclableContentPercentage	decimal	0..1	The percentage of all recycled material used to produce the trade item. Drives whether or not you can describe an item as recycled in advertising/marketing. This is the totalled recycled content including percentage of post consumer recycled. It excludes all packaging material.
Attribute	tradeItemSustainabilityFeatureCode	SustainabilityFeatureCode	0..*	A feature of the trade item that contributes to sustainability initiatives for example that it is made from renewable materials.
Attribute	tradeItemSustainabilityStatement	Description5000	0..*	The statement that describes how a trade item is produced in a way that can be maintained into the future without harming the environment. This may refer to marketing facing information that is relevant to the consumer who is concerned with sustainability.

content	attribute / role	datatype /secondary class	multipl city	definition
CarbonFootprintDetail				Information on carbon footprint, to be able to identify lifecycle stage, emission value and methodology used.
Attribute	cfpCountryCode	CfpCountryCode	0..*	The code specifying a target market for which the carbon footprint values have been calculated. Transportation emissions can greatly vary from country to country.
Attribute	cfpBoundariesCode	CfpBoundariesCode	0..*	The code identifying the life cycle stage that the product carbon footprint value refers to. The boundary setting may vary depending on the purpose of the product carbon footprint assessment.
Attribute	cfpValue	Measurement	0..1	The emissions value, i.e., carbon footprint, for a specific boundary setting.
Attribute	cfpFunctionalUnit	Description2000	0..1	The functional unit describes the quantity and/or performance characteristics of a product as it is used by the end-user, which forms the basis for calculating the emissions value (i.e., carbon footprint), and can be used for comparison to other similar products.
Attribute	cfpMethodologyCode	CfpMethodologyCode	0..1	The code specifying the method used to assess and communicate the environmental impact of the product in terms of carbon footprint.
Attribute	cfpValueVerificationCode	CfpValueVerificationCode	0..1	The code indicating how the calculated carbon footprint value is verified.
Attribute	cfpAccountingCode	cfpAccountingCode	0..1	The code indicating which method is used to conduct the lifecycle assessment for carbon footprint calculation.
Attribute	cfpDate	dateTime	0..1	The date on which the product carbon footprint assessment was conducted.
SustainabilityProgramInformation				Provides the information on sustainability programs, i.e. programs which are designed to encourage people to buy products with a low(er) environmental footprint.
Attribute	sustainabilityScore	String	1..1	The score, using points or a rating system, assigned to a product by the associated sustainability program. Please refer to any local regulations concerning score.
Attribute	sustainabilityProgramCode	SustainabilityProgramCode	0..1	The code identifying the sustainability program, against which the product was evaluated.
Attribute	sustainabilityValue	decimal	0..1	The numeric value assigned to a product by the associated sustainability program. Please refer to any local regulations concerning the value.
SustainabilityModule				Properties of the trade item that can affect the ecological or human environment.
Association		TradeItemSustainabilityInformation	0..1	Properties of the trade item that can affect the ecological or human environment.

5.62 Trade Item Data Carrier And Identification Module

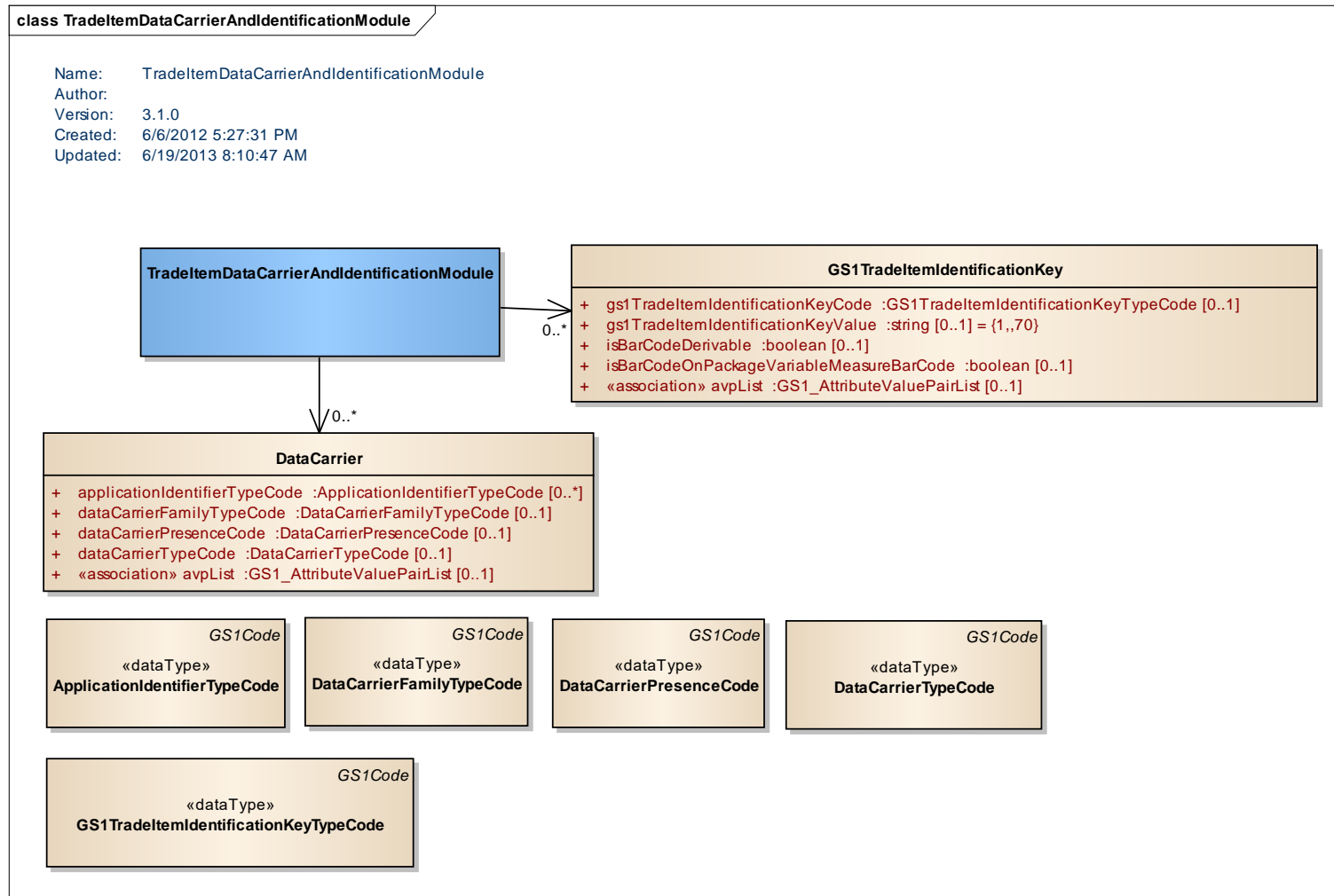



Content	Attribute / Role	Datatype /Secondary class	Multiplcity	Definition
TradeItemDataCarrierAndIdentificationModule				A module containing information on any Data Carriers or GS1 Application Identifiers associated with the trade item.
Association		DataCarrier	0..*	A means to represent data in a machine readable form; used to enable automatic reading of the element strings.
Association		GS1TradeItemIdentificationKey	0..*	Details on additional GS1 trade item identifiers present for the trade item.
DataCarrier				A means to represent data in a machine readable form; used to enable automatic reading of the element strings.
Association	avpList	GS1_AttributeValuePairList	0..1	Attribute value pair information.
Attribute	applicationIdentifierTypeCode	ApplicationIdentifierTypeCode	0..*	Indication of which Application Identifier's (AI) presence is indicated for example 10 (batch number),15 (best-before-date),17 (expiry date), 310(n) (net weight in kilogram).
Attribute	dataCarrierFamilyTypeCode	DataCarrierFamilyTypeCode	0..1	A high-level grouping of data carriers for example GS1 Data Bar.
Attribute	dataCarrierPresenceCode	DataCarrierPresenceCode	0..1	A code that indicates if the trade item has or could have a certain data carrier present.
Attribute	dataCarrierTypeCode	DataCarrierTypeCode	0..1	A code indicating the type of data carrier physically present on the trade item.
GS1TradeItemIdentificationKey				Details on additional GS1 trade item identifiers present for the trade item.
Association	avpList	GS1_AttributeValuePairList	0..1	Attribute value pair information.
Attribute	gs1TradeItemIdentificationKeyCode	gs1TradeItemIdentificationKeyCode	0..1	The Global Trade Item Number which is visible on the item or its packaging and can be used to identify a trade item.
Attribute	gs1TradeItemIdentificationKeyValue	String	0..1	A value for the alternative means to the Global Trade Item Number to identify a trade item.
Attribute	isBarcodeDerivable	Boolean	0..1	A boolean field determining that the data structure on the trade item can be derived from the GTIN.



Content	Attribute / Role	Datatype /Secondary class	Multipli city	Definition
Attribute	isBarCodeOnPackage VariableMeasureBarC ode	Boolean	0..1	An indicator identifying if the bar code that is printed on the trade item package is a variable measure bar code.

5.63 Trade Item Description Module

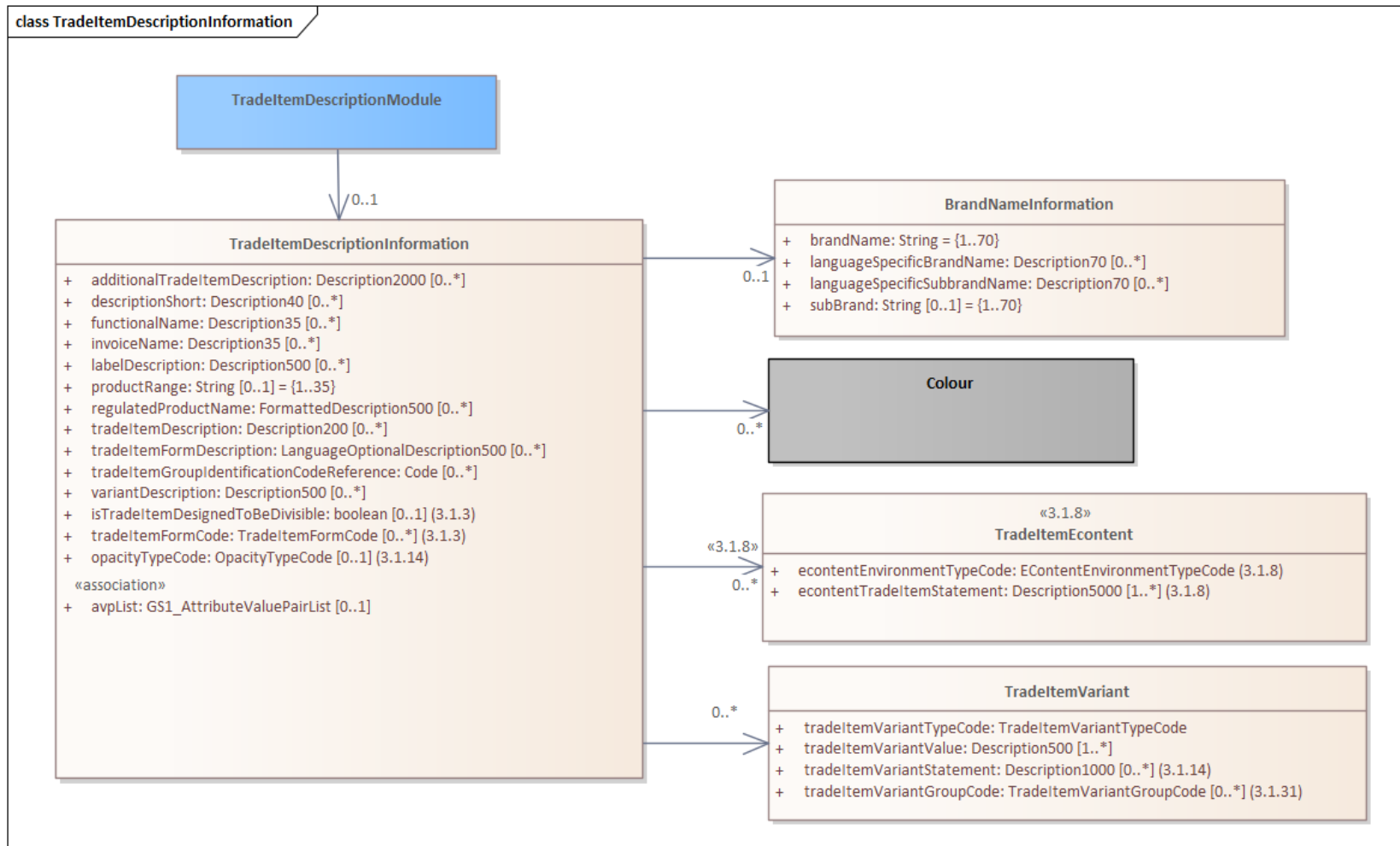

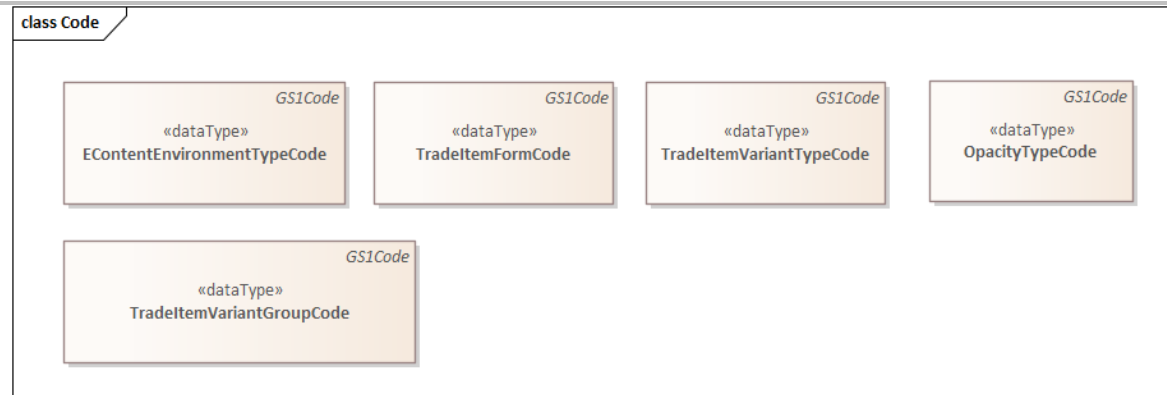

content	attribute / role	datatype /secondary class	multiplcity	definition
TradeItemDescriptionModule				A module carrying general descriptions of the trade item including brand, form, variant.
Association		TradeItemDescriptionInformation	0..1	Description Information for the trade item.
TradeItemDescriptionInformation				Description Information for the trade item.
Association		BrandNameInformation	0..1	Information on brands and sub-brands for a trade item.
Association		Colour	0..*	Information specifying a colour in text and / or coded format.
Association		TradeItemEcontent	0..*	Additional information relating to the trade item. This is specifically addressing website and mobile device content for consumers.
Association		TradeItemVariant	0..*	Provides a code to identify the variant type and name of the product (e.g. Taste, Grape). Variants are the distinguishing characteristics that differentiate products with the same brand and size including such things as the particular flavor, fragrance, taste.
Association	avpList	GS1_AttributeValuePairList	0..1	Attribute value pair information.

content	attribute / role	datatype /secondary class	multipl city	definition
Attribute	additionalTradeItemDescription	Description2000	0..*	Additional variants necessary to communicate to the industry to help define the product. Multiple variants can be established for each GTIN. This is a repeatable field, e.g. Style, Colour, and Fragrance.
Attribute	descriptionShort	Description40	0..*	A free form short length description of the trade item that can be used to identify the trade item at point of sale.
Attribute	functionalName	Description35	0..*	Describes use of the product or service by the consumer. Should help clarify the product classification associated with the GTIN.
Attribute	invoiceName	Description35	0..*	Free form information provider assigned trade item description designed to match trade item/service description as noted on invoices.
Attribute	labelDescription	Description500	0..*	A literal reproduction of the text featured on a product's label in the same word-by-word order in which it appears on the front of the product's packaging. This may not necessarily match the GTIN description as loaded by the supplier into the GTIN description field in GDSN.
Attribute	opacityTypeCode	OpacityTypeCode	0..1	A code to describe the opacity achieved by the product. The codes may vary by product type. Examples Cosmetics, Glass, Paints and Wood Stains.
Attribute	productRange	string	0..1	A name, used by a BrandOwner, that span multiple consumer categories or uses. E.g. (Waist Watchers).
Attribute	regulatedProductName	FormattedDescription500	0..*	The prescribed, regulated or generic product name or denomination that describes the true nature of the item and is sufficiently precise to distinguish it from other products according to country specific regulation.

content	attribute / role	datatype /secondary class	multiplcity	definition
Attribute	tradeItemDescription	Description200	0..*	<p>An understandable and useable description of a trade item using brand and other descriptors.</p> <p>This attribute is filled with as little abbreviation as possible while keeping to a reasonable length.</p> <p>This should be a meaningful description of the trade item with full spelling to facilitate message processing. Retailers can use this description as the base to fully understand the brand, flavour, scent etc. of the specific GTIN in order to accurately create a product description as needed for their internal systems.</p> <p>Examples:</p> <ul style="list-style-type: none"> • GS1 Brand Base Invisible Solid Deodorant AP Stick Spring Breeze • GS1 Brand Laundry Detergent Liquid Compact Regular Instant Stain 1 • GS1 Brand Hair Colour Liquid Light to Medium Blonde.
Attribute	tradeItemFormDescription	languageOptionalDescription500	0..*	The physical form or shape of the product. Used, for example, in pharmaceutical industry to indicate the formulation of the trade item. Defines the form the trade item takes and is distinct from the form of the packaging.
Attribute	tradeItemGroupIdentificationCodeReference	Code	0..*	A code assigned by the supplier or manufacturer to logically group trade item independently from the Global trade item Classification.
Attribute	variantDescription	Description500	0..*	Free text field used to identify the variant of the product. Variants are the distinguishing characteristics that differentiate products with the same brand and size including such things as the particular flavour, fragrance, taste.
Attribute	isTradeItemDesignedToBeDivisible	boolean	0..1	Indicates whether the trade item or a single unit may be divided or separated into multiple pre-determined portions. A fraction or divisible amount of the total quantity of a trade item so as to obtain the desired amount.
Attribute	tradeItemFormCode	TradeItemFormCode	0..*	A code representation of the form of the actual trade item, not the packaging for example OBLONG.
BrandNameInformation				Information on brands and sub-brands for a trade item.

content	attribute / role	datatype /secondary class	multiplcity	definition
Attribute	brandName	string	1..1	The recognisable name used by a brand owner to uniquely identify a line of trade item or services. This is recognizable by the consumer.
Attribute	languageSpecificBrandName	Description70	0..*	The recognisable name used by a brand owner to uniquely identify a line of trade item or services expressed in a different language than the primary brand name (brandName).
Attribute	languageSpecificSubbrandName	Description70	0..*	A second level of brand expressed in a different language than the primary sub-brand name (subBrand).
Attribute	subBrand	string	0..1	Second level of brand. Can be a trademark. It is the primary differentiating factor that a brand owner wants to communicate to the consumer or buyer. E.g. Yummy-Cola Classic. In this example Yummy-Cola is the brand and Classic is the subBrand.
TradeItemContent				Additional information relating to the trade item. This is specifically addressing website and mobile device content for consumers.
Attribute	econtentEnvironmentTypeCode	EcontentEnvironmentTypeCode	1..1	A code providing the digital medium, website and applications that enable consumers to access, create and share content in social networking.
Attribute	econtentTradeItemStatement	Description5000	1..*	A free text field providing additional information relating to the trade item. This is specifically addressing ecommerce content for consumers.
TradeItemVariant				Provides a code to identify the variant type and name of the product (e.g. Taste, Grape). Variants are the distinguishing characteristics that differentiate products with the same brand and size including such things as the particular 377ilenam, fragrance, taste.
Attribute	tradeItemVariantStatement	Description1000	0..*	A complete statement describing the variant, that may comply with any regulatory requirements in a target market. Example for flavour: Barbecue with natural and artificial flavours.
Attribute	tradeItemVariantTypeCode	TradeItemVariantTypeCode	1..1	Provides a code to identify the variant type of the product (e.g. Flavour).
Attribute	tradeItemVariantValue	Description500	1..*	The variant value for a variant type (e.g. Grape).
Attribute	tradeItemVariantGroupCode	TradeItemVariantGroupCode	0..*	The code that represents the variant of the trade item into a similar grouping.

5.64 Trade Item Disposal Information Module

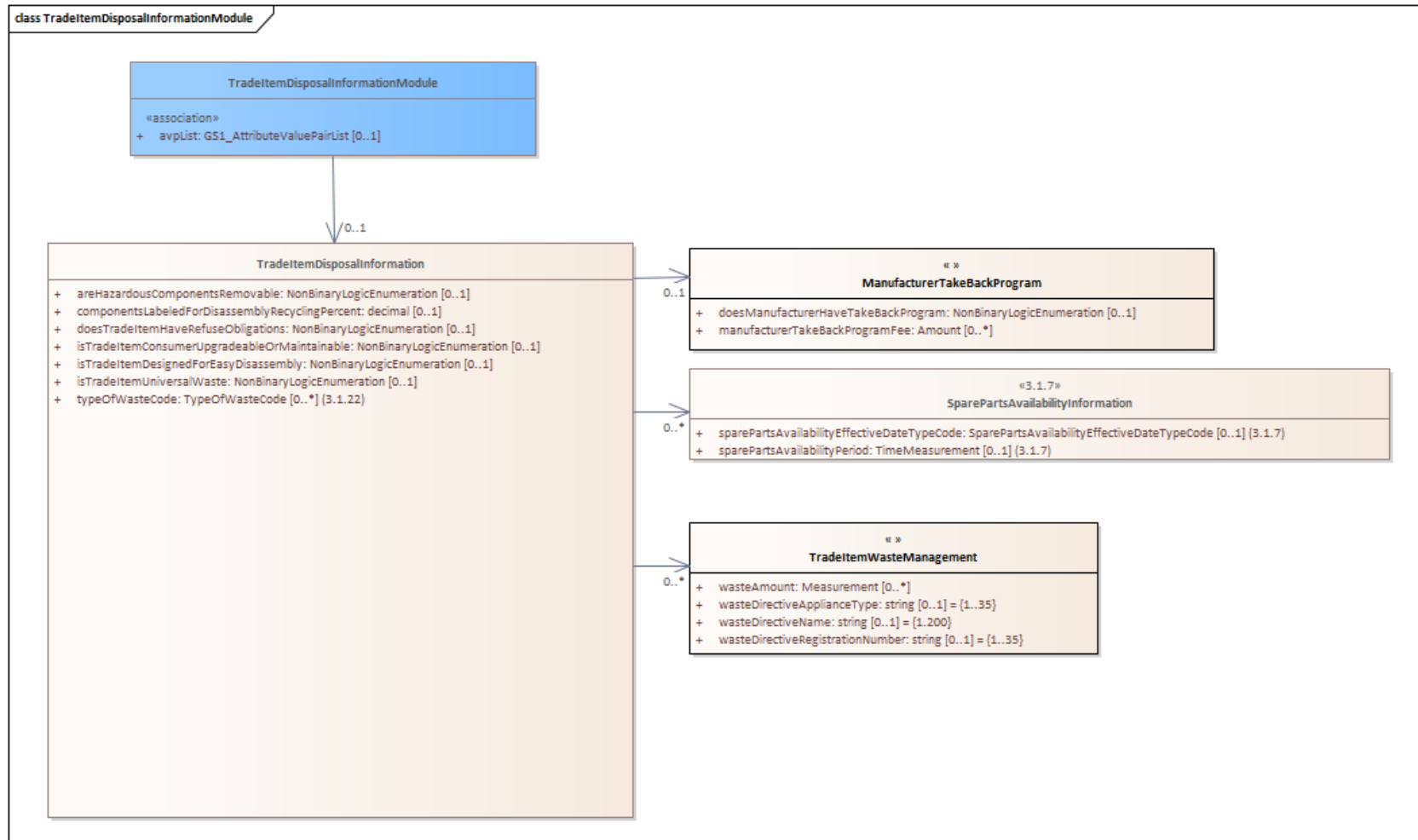

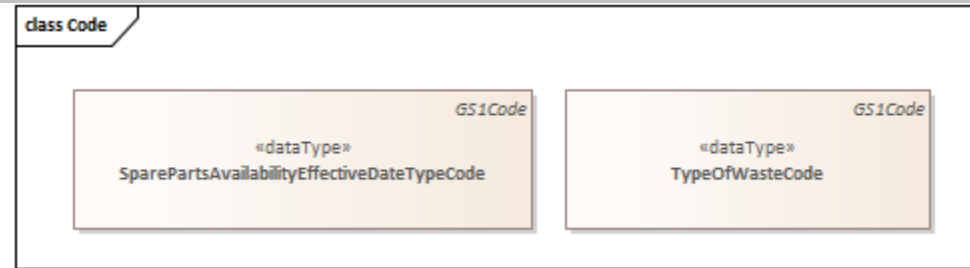

content	attribute / role	datatype /secondary class	multiplcity	definition
ManufacturerTakeBackProgram				Details on any take back program offered to consumers for the product to be reused, re-manufactured or recycled by the manufacturer.
Attribute	doesManufacturerHaveTakeBackProgram	NonbinaryLogicEnumeration	0..1	Indicates if the manufacturer of the trade item offers any take back programs to consumers for the product to be reused, re-manufactured or recycled by the manufacturer.
Attribute	manufacturerTakeBackProgramFee	Amount	0..*	The fee the consumer must pay the manufacturer to take back the product.
SparePartsAvailabilityInformation				Details on whether or not spare parts are available for the product and the time period that they are available for.
Attribute	sparePartsAvailabilityEffectiveDateTypeCode	SparePartsAvailabilityEffectiveDateTypeCode	0..1	The type of date expressed as a code associated with the period of availability of spare parts usually expressed as an event date for the item for example DATE_OF_PURCHASE_BY_CONSUMER, DATE_OF_MANUFACTURE or DATE_OF_DELIVERY.
Attribute	sparePartsAvailabilityPeriod	TimeMeasurement	0..1	The period of availability of spare parts for a trade item associated with the sparePartsAvailabilityEffectiveDateTypeCode for example 24 MON.
TradeItemDisposalInformation				Information on the disposal of the trade item for the purposes of sustainability.
Association		ManufacturerTakeBackProgram	0..1	Details on any take back program offered to consumers for the product to be reused, re-manufactured or recycled by the manufacturer.
Association		SparePartsAvailabilityInformation	0..*	Spare parts information for a trade item.

content	attribute / role	datatype /secondary class	multiplcity	definition
Association		TradeItemWasteManagement	0..*	Information on waste management for a trade item.
Attribute	areHazardousComponentsRemovable	NonbinaryLogicEnumeration	0..1	An indicator if any hazardous components contained within the trade item can easily be separated from the other materials to facilitate product recycling.
Attribute	componentsLabeledForDisassemblyRecyclingPercent	decimal	0..1	The percentage of trade item components that clearly label how to facilitate product disassembly and recycling. For example if the product is a VCR and remote control and the remote control is labelled for recycling, but the VCR is not the percentage equals 50.
Attribute	doesTradeItemHaveRefuseObligations	NonbinaryLogicEnumeration	0..1	Indicates if there are special disposal obligations that apply to the trade item for example INTRASTAT.
Attribute	isTradeItemConsumerUpgradeableOrMaintainable	NonbinaryLogicEnumeration	0..1	Indicates if a product can be easily upgraded or have parts replaced by the consumer. For example, the ability to add additional memory/storage capacity or access and replace chargeable batteries.
Attribute	isTradeItemDesignedForEasyDisassembly	NonbinaryLogicEnumeration	0..1	Indicates that the trade item is designed for easy disassembly by recycling facilities using standard industry tools.
Attribute	isTradeItemUniversalWaste	NonbinaryLogicEnumeration	0..1	Indicates if a product can be considered universal waste. Universal waste is defined as "wastes that do meet the regulatory definition of hazardous waste, but are managed under special, tailored regulations.
Attribute	typeOfWasteCode	TypeOfWasteCode	0..*	The code that describes the type of waste created from the product. Please refer to any local regulation requirements for disposal/recyclable waste.
TradeItemDisposalInformationModule				Information on the disposal of the trade item for the purposes of sustainability.
Association		TradeItemDisposalInformation	0..1	Information on the disposal of the trade item for the purposes of sustainability.
Association	avpList	GS1_AttributeValuePairList	0..1	Attribute value pair information.
TradeItemWasteManagement				Information on waste management for a trade item.

content	attribute / role	datatype /secondary class	multiplcity	definition
Attribute	wasteAmount	Measurement	0..*	The amount of the components contained in the trade item that are covered by a waste directive for example WEEE.
Attribute	wasteDirectiveApplianceType	string	0..1	The category of electrical and electronic equipment containing components covered by a waste directive for example WEEE.
Attribute	wasteDirectiveName	string	0..1	The name of a waste directive for example WEEE.
Attribute	wasteDirectiveRegistrationNumber	string	0..1	A registration number for a trade item required by a waste directive (e.g. WEEE).

5.65 Trade Item Handling Module

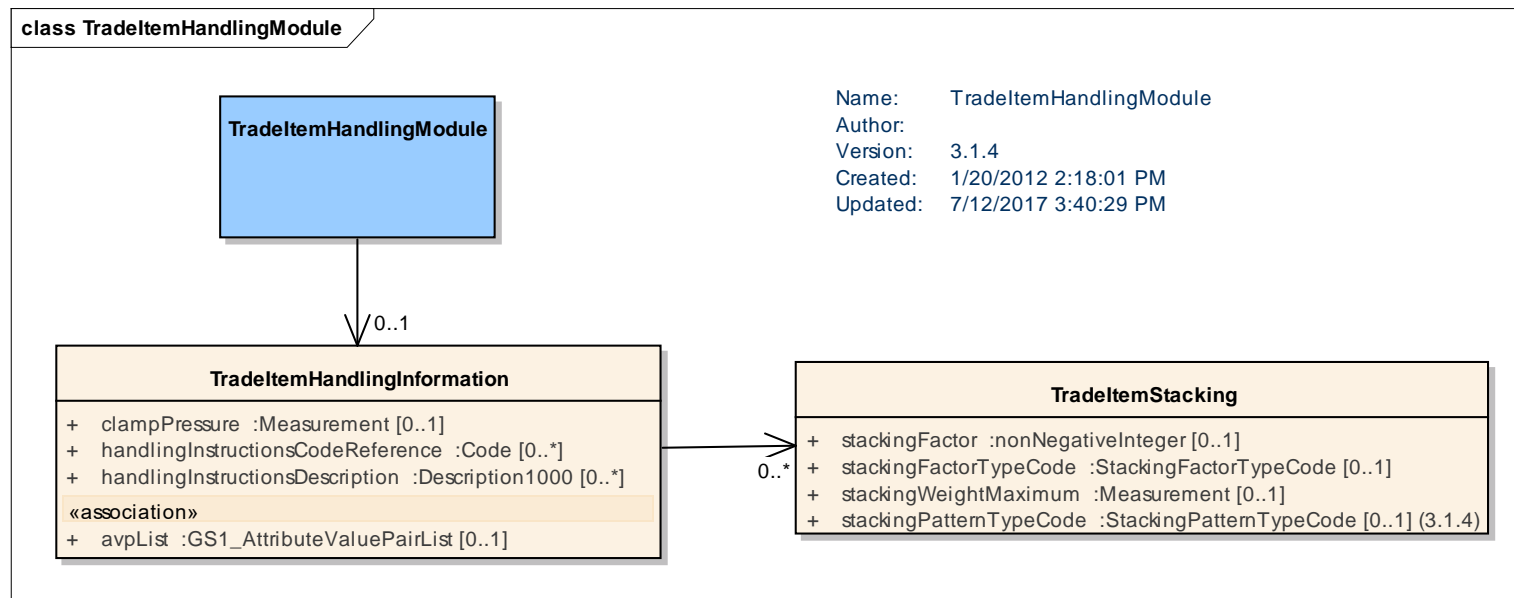

content	attribute / role	datatype /secondary class	multiplcity	definition
TradeItemStacking				Information on the stacking for a trade item in the supply chain..
Attribute	stackingFactor	nonNegativeInteger	0..1	A factor that determines the maximum stacking for the product. Indicates the number of levels the product may be stacked.
Attribute	stackingFactorTypeCode	StackingFactorTypeCode	0..1	Indicates the supply chain process that the particular product may be stacked in. From a supply chain perspective, these values can differ from a storage perspective, truck transport, rail, etc. If a retailer is shipping between warehouses or store, they need the information to support their supply chain. For example a truck can only be stack 2 pallets high, but in a warehouse that can be 3 pallets
Attribute	stackingPatternTypeCode	StackingPatternTypeCode	0..1	Indicates the pattern the product is stacked on a logistics unit, for example column pattern or interlocking pattern.
Attribute	stackingWeightMaximum	Measurement	0..1	The maximum admissible weight that can be stacked on the trade item. This uses a measurement consisting of a unit of measure and a value. This will be used for transport or storage to allow user to know by weight how to stack different trade item one on top of the other.
TradeItemHandlingInformation				Instruction on the way to treat goods during transport and storage.
Association		TradeItemStacking	0..*	Information on the stacking for a trade item in the supply chain.
Association	avpList	GS1_AttributeValuePairList	0..1	Attribute value pair information.
Attribute	clampPressure	Measurement	0..1	The pressure that should be applied by a clamp to the packaging around the product.
Attribute	handlingInstructionsCodeReference	Code	0..*	Defines the information and processes needed to safely handle the trade item. Use HandlingInstructionsCode_GDSN to populate.
Attribute	handlingInstructionsDescription	Description1000	0..*	Information and processes needed to safely handle the trade item. Intended to be sent when handling Instructions Code and agency have not been provided.
TradeItemHandlingModule				A module containing instructions on the way to treat goods during transport and storage.

content	attribute / role	datatype /secondary class	multiplcity	definition
Association		TradeItemHandling Information	0..1	Instruction on the way to treat goods during transport and storage.

5.66 Trade Item Hierarchy Module

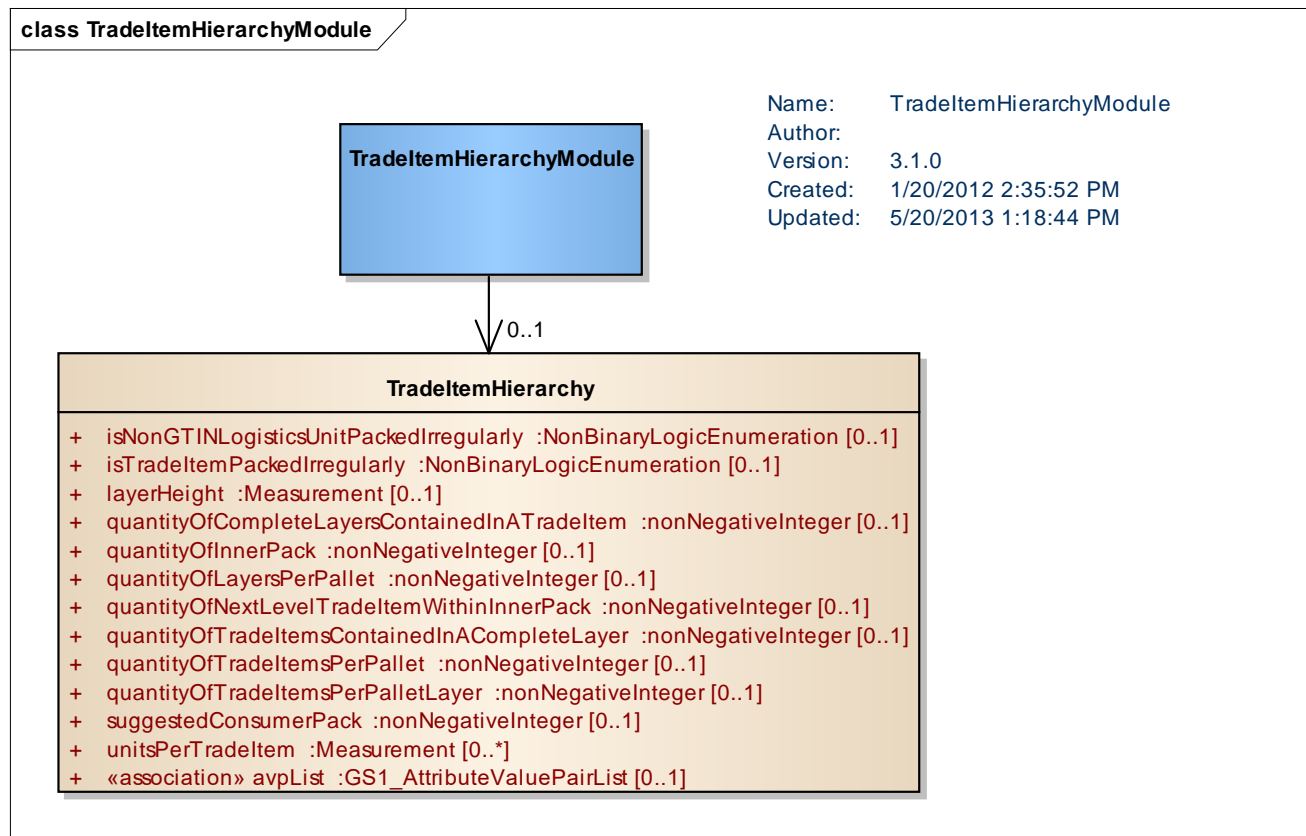

content	attribute / role	datatype /secondary class	multiplcity	definition
TradeItemHierarchy				Information on how the hierarchical structure of a trade item for example number of layers on a pallet.
Association	avpList	GS1_AttributeValuePairList	0..1	Attribute value pair information.
Attribute	isNonGTINLogisticsUnitPackedIrregularly	NonBinaryLogicEnumeration	0..1	Indicates that the Non-GTIN Logistic Unit is packed in a non-rectilinear pattern such that it is not meaningful to send the number of child trade items in the width/depth/height.
Attribute	isTradeItemPackedIrregularly	NonBinaryLogicEnumeration	0..1	Indicates that the item is packed in a non-rectilinear pattern such that it is not meaningful to send the number of child trade items in the width/depth/height.
Attribute	layerHeight	Measurement	0..1	The height of each layer of child trade items when packed in layers. This attribute may be used when child items are packed in layers, but the child items are not packed on their natural base.
Attribute	quantityOfCompleteLayersContainedInATradeItem	nonNegativeInteger	0..1	The number of layers of the base trade item found in a trade item. Does not apply to the base trade item unit.
Attribute	quantityOfInnerPacks	nonNegativeInteger	0..1	Indicates the number of non-GTIN assigned inner-packs of next lower level trade items within the current GTIN level.
Attribute	quantityOfLayersPerPallet	nonNegativeInteger	0..1	The number of layers that a pallet contains. Only used if the pallet has no GTIN. It indicates the number of layers that a pallet contains, according to supplier or retailer preferences.
Attribute	quantityOfNextLevelTradeItemWithinInnerPack	nonNegativeInteger	0..1	Indicates the number of next lower level trade items contained within the physical non-GTIN assigned each or inner-packs (inner-pack).
Attribute	quantityOfTradeItemsContainedInACompleteLayer	nonNegativeInteger	0..1	The number of trade items contained in a complete layer of a higher packaging configuration. Used in hierarchical packaging structure of a trade item. Cannot be used for trade item base unit.
Attribute	quantityOfTradeItemsPerPallet	nonNegativeInteger	0..1	The number of trade items contained in a pallet. Only used if the pallet has no GTIN. It indicates the number of trade items placed on a pallet according to supplier or retailer preferences.

content	attribute / role	datatype /secondary class	multipl city	definition
Attribute	quantityOfTradeItemsPerPalletLayer	nonNegativeInteger	0..1	The number of trade items contained on a single layer of a pallet. Only used if the pallet has no GTIN. It indicates the number of trade items placed on a pallet layer according to supplier or retailer preferences.
Attribute	suggestedConsumerPack	nonNegativeInteger	0..1	The pack quantity of an item which aligns to the suggested consumer pack.
Attribute	unitsPerTradeItem	Measurement	0..*	Numeric value to indicate number of physical pieces used to make up the Consumer Unit. Used if there is more than one piece in one Trade Item.
TradeItemHierarchyModule				A module containing information on how the hierarchical structure of a trade item for example number of layers on a pallet.
Association		TradeItemHierarchy	0..1	Information on how the hierarchical structure of a trade item for example number of layers on a pallet.

5.67 Trade Item Humidity Information Module

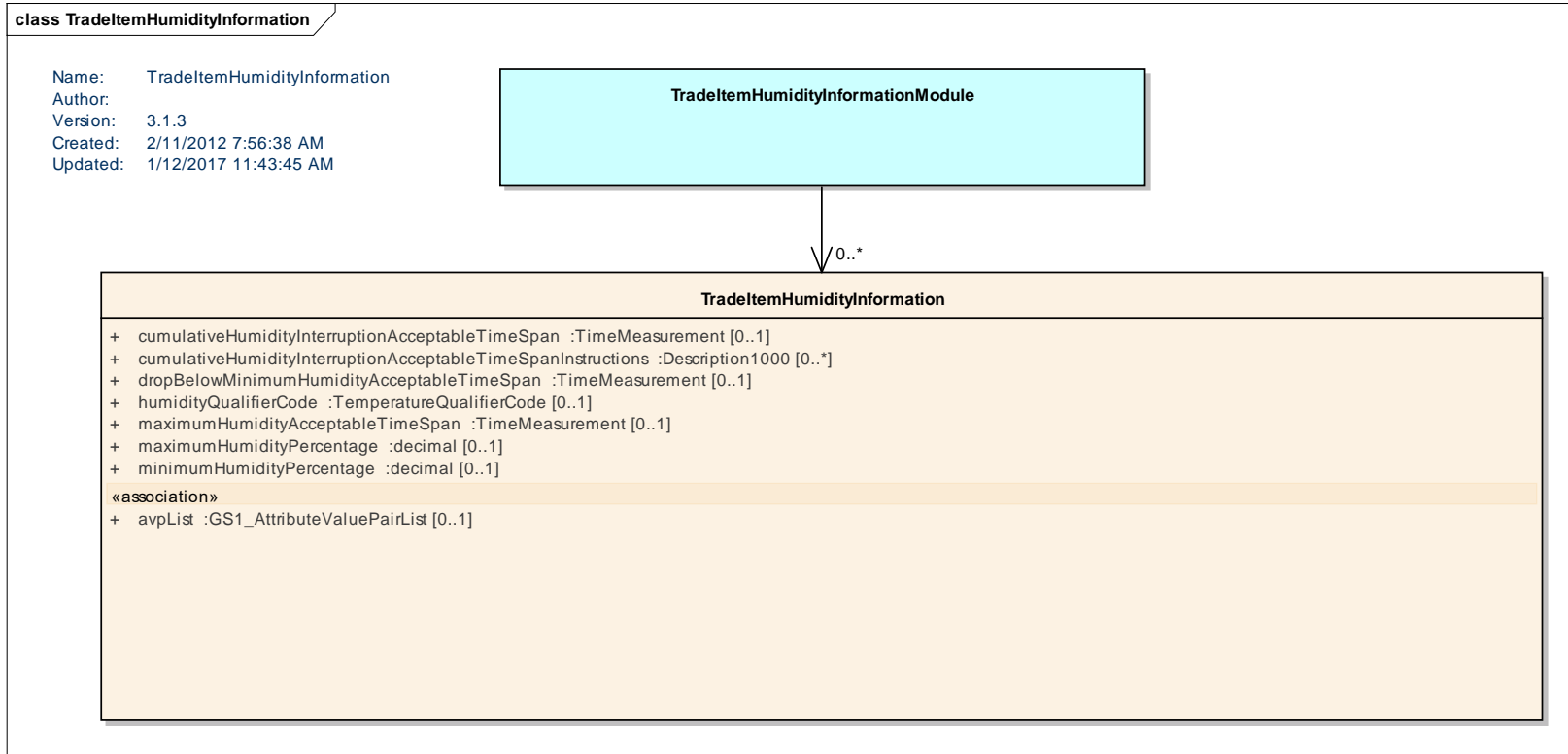

content	attribute / role	datatype /secondary class	multiplcity	definition
TradeItemHumidityInformation				Information on permissible humidity of a trade item during various points of the supply chain.
Association	avpList	GS1_AttributeValuePairList	0..1	Attribute value pair information.
Attribute	cumulativeHumidityInterruptionAcceptableTimeSpan	TimeMeasurement	0..1	An expression of the maximum allowed cumulative time span of one or more humidity interruptions of a trade item as defined by the manufacturer.
Attribute	cumulativeHumidityInterruptionAcceptableTimeSpanInstructions	Description1000	0..*	Instructions provided by the product manufacturer regarding the process, procedures, or handling instructions for trade items that has exceeded the cumulative time span of humidity interruptions.

content	attribute / role	datatype /secondary class	multiplcity	definition
Attribute	dropBelowMinimumHumidityAcceptableTimeSpan	TimeMeasurement	0..1	The amount of time that a product can fall below the minimum humidity threshold as defined by the manufacturer without affecting product safety or quality.
Attribute	humidityQualifierCode	TemperatureTypeQualifierCode	0..1	Code qualifying the type of a humidity for example STORAGE.
Attribute	maximumHumidityAcceptableTimeSpan	TimeMeasurement	0..1	The amount of time that a product can safely rise above the maximum humidity threshold as defined by the manufacturer without affecting product safety or quality.
Attribute	maximumHumidityPercentage	Decimal	0..1	The maximum humidity in percentages that the goods should be stored in.
Attribute	minimumHumidityPercentage	Decimal	0..1	The minimum humidity in percentages that the goods should be stored in
TradeItemHumidityInformationModule				A module containing information on permissible humidity of a trade item during various points of the supply chain.
Association		TradeItemHumidityInformation	0..*	Information on permissible humidity of a trade item during various points of the supply chain.

5.68 Trade Item Licensing Module

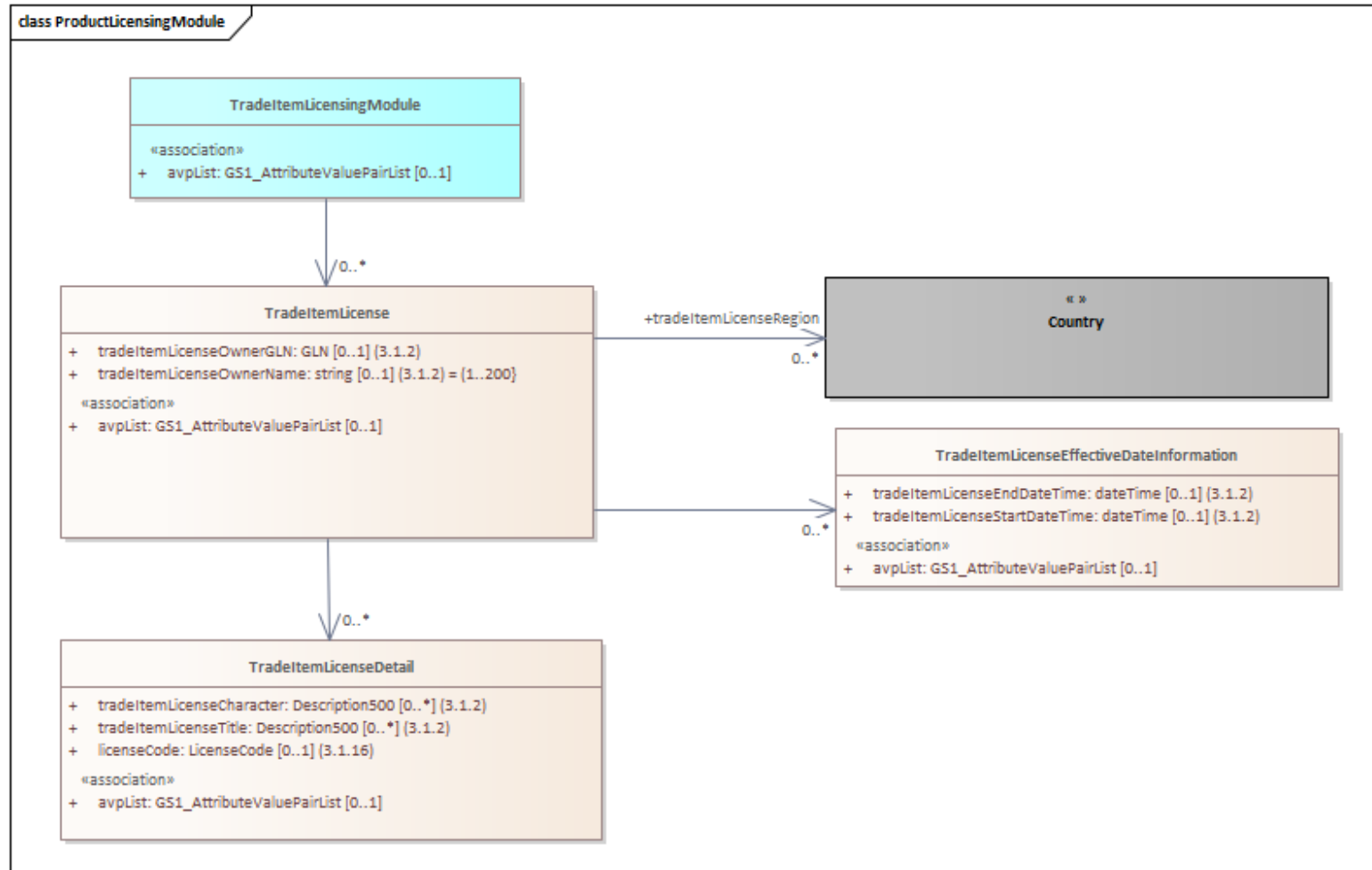

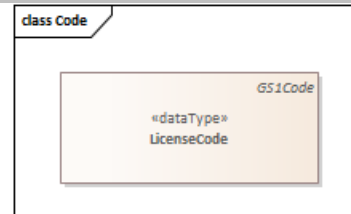

content	attribute / role	datatype /secondary class	multiplicity	definition
TradeItemLicense				A license to use the title, character or any trademarked assets that are used on the trade item.
Association		TradeItemLicenseDetail	0..*	Licensing information for a trade item.
Association		TradeItemLicenseEffectiveDateInformation	0..*	Provides the effective dates for a license to use the title, character or any trademarked assets that are used on the trade item.
Association	tradeItemLicenseRegion	Country	0..*	The region the license to use the title, character or any trademarked assets that are used on the trade item is only valid in.
Association	avpList	GS1_AttributeValuePairList	0..1	Attribute value pair information.
Attribute	tradeItemLicenseOwnerGLN	GLN	0..1	The GLN of the owner of the licensed product that is allowing the trading partner to use their licensed name and/or images.
Attribute	tradeItemLicenseOwnerName	string	0..1	The name of the owner of the licensed product that is allowing the trading partner to use their licensed name and/or images.
TradeItemLicenseDetail				Provides detail on for a specific product license.
Association	avpList	GS1_AttributeValuePairList	0..1	Attribute value pair information.
Attribute	licenseCode	LicenseCode	0..1	A code indicating the insignia of the league/sport/event which a given item bears.
Attribute	tradeItemLicenseCharacter	Description500	0..*	The character of the licensed trademark asset that is used on the trade item.
Attribute	tradeItemLicenseTitle	Description500	0..*	The title of the licensed trademark asset that is used on the trade item.

content	attribute / role	datatype /secondary class	multiplicity	definition
TradeItemLicenseEffectiveDateInformation				Provides the effective dates for a license to use the title, character or any trademarked assets that are used on the trade item.
Association	avpList	GS1_Attribute ValuePairList	0..1	Attribute value pair information.
Attribute	tradeItemLicenseEndDateTime	dateTime	0..1	The effective end date of the license to use the title, character or any trademarked assets that are used on the trade item.
Attribute	tradeItemLicenseStartDateTime	dateTime	0..1	The effective start date of the license to use the title, character or any trademarked assets that are used on the trade item.
TradeItemLicensingModule				A module for sending license information in relation to title, character or any trademarked assets that are used on the trade item.
Association		TradeItemLicense	0..*	License information in relation to title, character or any trademarked assets that are used on the trade item.
Association	avpList	GS1_Attribute ValuePairList	0..1	Attribute value pair information.

5.69 Trade Item Lifespan Module

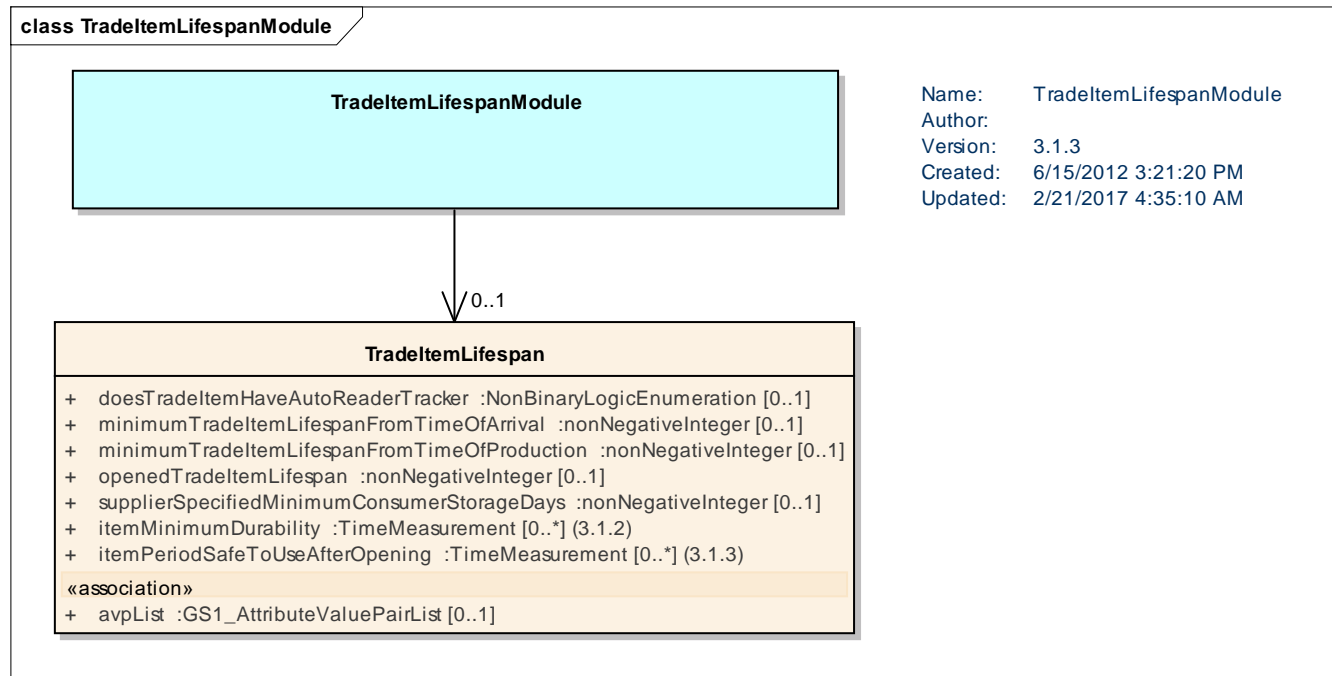

content	attribute / role	datatype /secondary class	multipl city	definition
TradeItemLifespan				Information on the amount of time the item can or should be used, sold, etc.
Association	avpList	GS1_AttributeValuePairList	0..1	Attribute value pair information.
Attribute	doesTradeItemHaveAutoReaderTracker	NonBinaryLogicEnumeration	0..1	Indication that the trade item has a device that identifies that the product has a limited number of reuses and is self tracked. Each time the device is used / plugged in it will decrement the count. When the counter reaches zero the trade item should be disposed of.
Attribute	itemMinimumDurability	TimeMeasurement	0..*	The length of time until which the product will continue to 391ilena its initial function and remain safe, i.e. the length of time by which it is best to use the product.

content	attribute / role	datatype /secondary class	multiplcity	definition
Attribute	minimumTradeItemLifespanFromTimeOfArrival	nonNegativeInteger	0..1	The period of days, guaranteed by the manufacturer, before the expiration date of the trade item, based on arrival to a mutually agreed to point in the buyers distribution system. Can be repeatable upon use of GLN.
Attribute	minimumTradeItemLifespanFromTimeOfProduction	nonNegativeInteger	0..1	The period of day, guaranteed by the manufacturer, before the expiration date of the product, based on the production.
Attribute	openedTradeItemLifespan	nonNegativeInteger	0..1	The number of days the trade item that had been opened can remain on the shelf and must then be removed.
Attribute	supplierSpecifiedMinimumConsumerStorageDays	nonNegativeInteger	0..1	Represents the number of days between a product's "sell by date" and its "use by date".
Attribute	itemPeriodSafeToUseAfterOpening	timeMeasurement	0..*	The period after the opening where the product is still safe to be used. The period of time after opening that the product may be used without any harm to the consumer. This mention MUST take the form of number of months or number of years for example 50 MON.
TradeItemLifespanModule				A module containing information on the amount of time the item can or should be used, sold, etc.
Association		TradeItemLifespan	0..1	Information on the amount of time the item can or should be used, sold, etc.

5.70 Trade Item Measurements Module

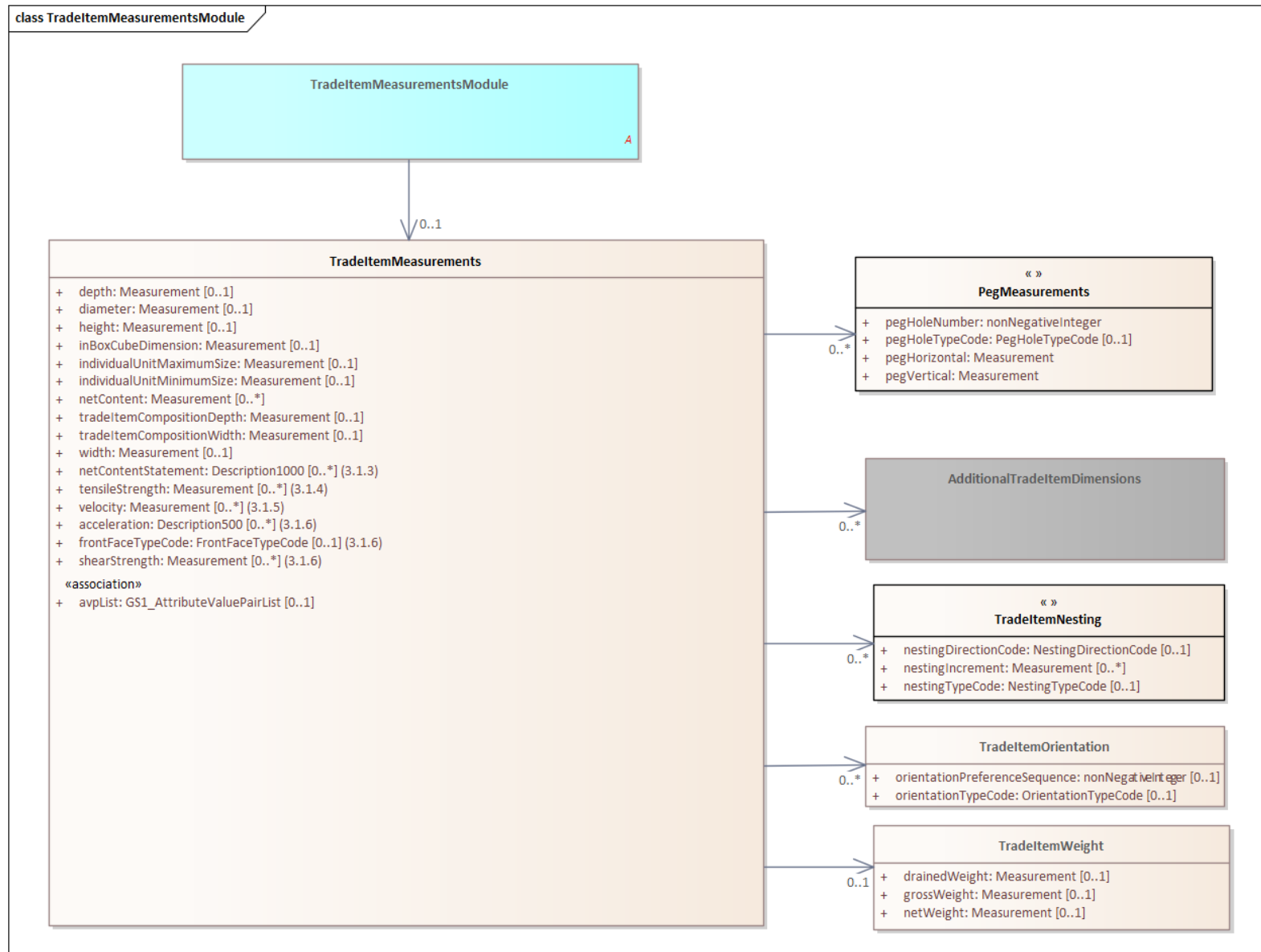

 **Note:** Common class (in grey) is located in the GDSN Common Library.

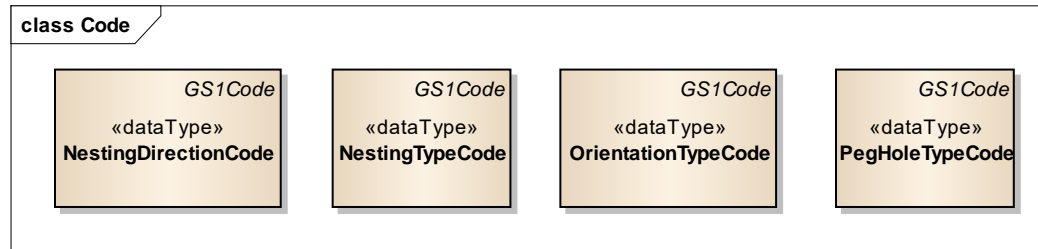

content	attribute / role	datatype /secondary class	multiplcity	definition
TradeItemMeasurements				Measurement information for the trade item.
Association		AdditionalTradeItemDimensions	0..*	Measurements for a trade item including dimensions.
Association		TradeItemOrientation	0..*	Orientation information for a trade item.
Association		TradeItemWeight	0..1	Details on weight for a trade item.
Association		TradeItemNesting	0..*	Details on how trade items nest with each other for the purpose of measurements.
Association		PegMeasurements	0..*	This class enables the description of multiple peg holes and their locations for a trade item.
Association	avpList	GS1_AttributeValuePairList	0..1	Attribute value pair information.
Attribute	acceleration	Description500	0..*	The rate of change of velocity. For example: 0 – 60 mph / 4.3 s; 0 – 100 kph / 4.5 s.

content	attribute / role	datatype /secondary class	multiplcity	definition
Attribute	depth	Measurement	0..1	The depth of the trade item, as measured according to the GS1 Package and Product Measurement Standard. If the trade item is a unit load, include the shipping platform unless it is excluded according to the platformTypeCode chosen.
Attribute	diameter	Measurement	0..1	The measurement of the diameter of the trade item at its largest point. For example, 165 "mmt", value – mmt, diameter. Has to be associated with valid UoM.
Attribute	frontFaceTypeCode	frontFaceTypeCode	0..1	The code used to indicate the front face of a shelf ready package (SRP) for the in-store shelf. E.g. WIDTH, DEPTH, DEPTH_OR_WIDTH).
Attribute	height	Measurement	0..1	The height of the trade item, as measured according to the GS1 Package and Product Measurement Standard. If the trade item is a unit load, include the shipping platform unless it is excluded according to the platformTypeCode chosen.
Attribute	inBoxCubeDimension	Measurement	0..1	The dimensions of an imaginary cube which can be drawn around the trade item as defined in the formula of H X W X D (The linear dimensions multiplied to get a cubic result). This only applies to In-box dimensions. Level of Hierarchy applied to- All. Example- Bag of cabbage, Bag of Flour, Broom, Ham, or Case of Beer.
Attribute	individualUnitMaximumSize	Measurement	0..1	Maximum size of the individual unit inside the lowest level of packaging.
Attribute	individualUnitMinimumSize	Measurement	0..1	Minimum size of the individual unit inside the lowest level of packaging.
Attribute	netContent	Measurement	0..*	The amount of the trade item contained by a package, usually as claimed on the label. For example, Water 750ml – net content = "750 MLT" ; 20 count pack of diapers, net content = "20 ea.". In case of multi-pack, indicates the net content of the total trade item. For fixed value trade items use the value claimed on the package, to avoid variable fill rate issue that arises with some trade item which are sold by volume or weight, and whose actual content may vary slightly from batch to batch. In case of variable quantity trade items, indicates the average quantity.

content	attribute / role	datatype /secondary class	multiplcity	definition
Attribute	netContentStatement	Description1000	0..*	The statement corresponding to the net content descriptions as stated on the packaging (e.g. "4 x 100 gr = 400 gr").
Attribute	shearStrength	Measurement	0..*	The strength of a material or component against the type of yield or structural failure where the material or component fails in shear. A shear load is a force that tends to produce a sliding failure on a material along a plane that is parallel to the direction of the force. When a paper is cut with scissors, the paper fails in shear. An example would be 7.82 KSI.
Attribute	tensileStrength	Measurement	0..*	The maximum stress it withstands before failing is its ultimate tensile strength. Ultimate tensile strength (UTS), often shortened to tensile strength (TS) or ultimate strength, is the maximum stress that a material can withstand while being stretched or pulled before failing or breaking. Example fishing line test, nylon rope.
Attribute	tradeItemCompositionDepth	Measurement	0..1	The number of child-items that are packaged from front to back in a trade unit. This information is used in the space process, especially when allocating whole Trade Units (intermediate) into the shelf.
Attribute	tradeItemCompositionWidth	Measurement	0..1	The number of child-items that are packaged beside each other in a trade unit (on the side facing the consumer). This information is used in the space process, especially when allocating whole Trade Units (intermediate) into the shelf. The Space Manager always allocates Base Units in the shelf. Usually there are no pictures of Trade Units available and for Hypermarkets/Big Supermarkets there is a need to allocate whole trade units into the shelves.
Attribute	width	Measurement	0..1	The width of the trade item, as measured according to the GS1 Package and Product Measurement Standard. If the trade item is a unit load, include the shipping platform unless it is excluded according to the platformTypeCode chosen.
Attribute	velocity	Measurement	0..*	The rate at which an object changes its position for example 5 metres per second (5 MTS).
TradeItemMeasurementsModule				A module containing measurement information for the trade item.
Association		TradeItemMeasurements	0..1	A module containing measurement information for the trade item.

content	attribute / role	datatype /secondary class	multiplcity	definition
TradeItemOrientation				Depicts one or many suggested orientations for the trade item for the purpose of display.
Attribute	orientationPreferenceSequence	nonNegativeInteger	0..1	Depicts the preferred sequence of orientation used to communicate the manufacturers relative preferences of orientation.
Attribute	orientationTypeCode	OrientationtypeCode	0..1	Depicts via code a display orientation for a trade item.
PegMeasurements				This class enables the description of multiple peg holes and their locations for a trade item.
Attribute	pegHoleNumber	nonNegativeInteger	1..1	Used to indicate the peg hole numbers when more than one hole is present in the product or packaging. Peg holes should be numbered from the upper left corner of the front of the package to the bottom right corner.
Attribute	pegHoleTypeCode	PegHoleTypeCode	0..1	A code depicting the type and shape of the peg hole used for the packaging.
Attribute	pegHorizontal	Measurement	1..1	Used to indicate the horizontal distance from the left edge of the trade item to the center of the hole into which the peg is inserted when the trade item is displayed on a pegboard. Example: "2 INH." Required if the trade item is displayed on a peg board.
Attribute	pegVertical	Measurement	1..1	Used to indicate the vertical distance of a peg hole measured from the bottom edge of the trade item to the top of the peg hole. Peg holes are inserted when the trade item is displayed on a pegboard. Example: "2 INH." Information is required if the trade item is displayed on a peg board.
TradeItemNesting				Details on how trade items nest with each other for the purpose of measurements.
Attribute	nestingDirectionCode	NestingDirectionCode	0..1	Depicts the arrangement of two items that nest together specifically whether they nest against each other or on top of each other.
Attribute	nestingIncrement	Measurement	0..*	Indicates the incremental height of Trade Items nested together. In the case of two garbage cans nested together, this would be the height between the lip of the lower can and the lip on the upper can.
Attribute	nestingTypeCode	NestingTypeCode	0..1	Depicts whether a nested item fits inside or over the other item in a nesting relationship.

content	attribute / role	datatype /secondary class	multiplcity	definition
TradeItemWeight				Information on the weight of a trade item.
Attribute	drainedWeight	Measurement	0..1	The weight of the trade item when drained of its liquid. For examples 225 "grm", Jar of pickles in vinegar. Applies to defined bricks of GCI Global trade item Classification – Mainly food trade item. Has to be associated with a valid UoM.
Attribute	grossWeight	Measurement	0..1	Used to identify the gross weight of the trade item. The gross weight includes all packaging materials of the trade item. At pallet level the trade item, grossWeight includes the weight of the pallet itself. For example, "200 GRM", value – total pounds, total grams, etc. Has to be associated with a valid UOM.
Attribute	netWeight	Measurement	0..1	Used to identify the net weight of the trade item. Net weight excludes any packaging materials. Has to be associated with a valid UoM.

5.71 Trade Item Size Module

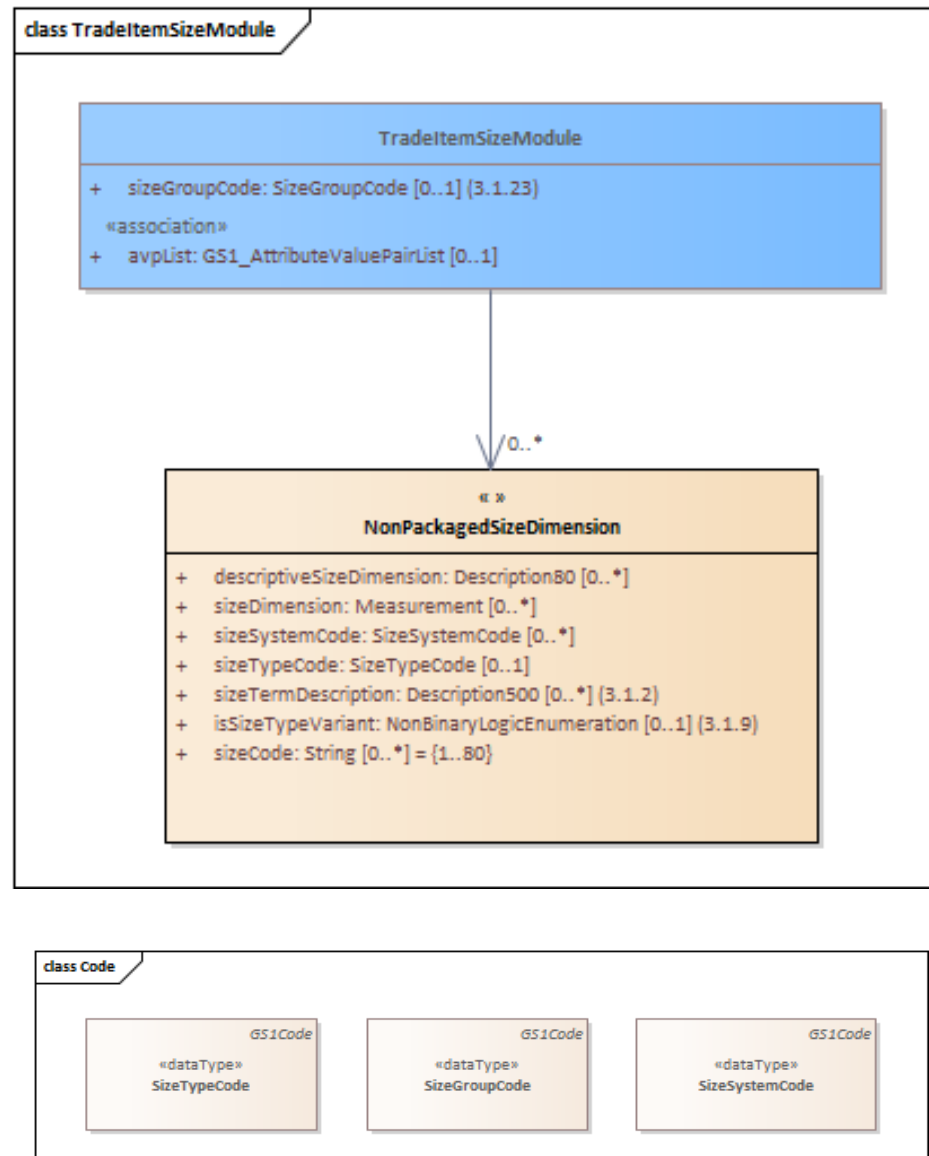

Content	attribute / role	datatype /secondary class	multipl city	definition
TradeItemSizeModule				A module specifying the size of an object as a code or a description.
Attribute	sizeGroupCode	SizeGroupCode	0..1	A description of the variable size that is necessary to uniquely specify the size of the item in conjunction with the non-packaged size dimension.
Association	avpList	GS1_AttributeValuePairList	0..1	Attribute value pair information.
NonPackagedSizeDimension				Size information related to apparel trade items.
Attribute	descriptiveSizeDimension	Description80	0..*	The textual representation of the size dimension specified by the size type.
Attribute	sizeDimension	Measurement	0..*	The numerical size measurement of the size dimension specified by the size type.
Attribute	sizeSystemCode	SizeSystemCode	0..*	The system that is used to define the size. It is used in conjunction with size group to completely define the size dimension.
Attribute	sizeTermDescription	Description500	0..*	The textual size specified by the size type expressed as a free-form text field for example 10 Medium or for diamonds a clarity of G-H.
Attribute	sizeTypeCode	SizeTypeCode	0..1	The type of size dimension being specified by the size measurement.
Attribute	isSizeTypeVariant	NonBinaryLogicEnumeration	0..1	Identifies whether a specific size type (sizeTypeCode) is considered a product variant for a trade item.
Attribute	sizeCode	String	0..*	A code depicting the size of an object according to a specified list of code

5.72 Trade Item Temperature Information Module

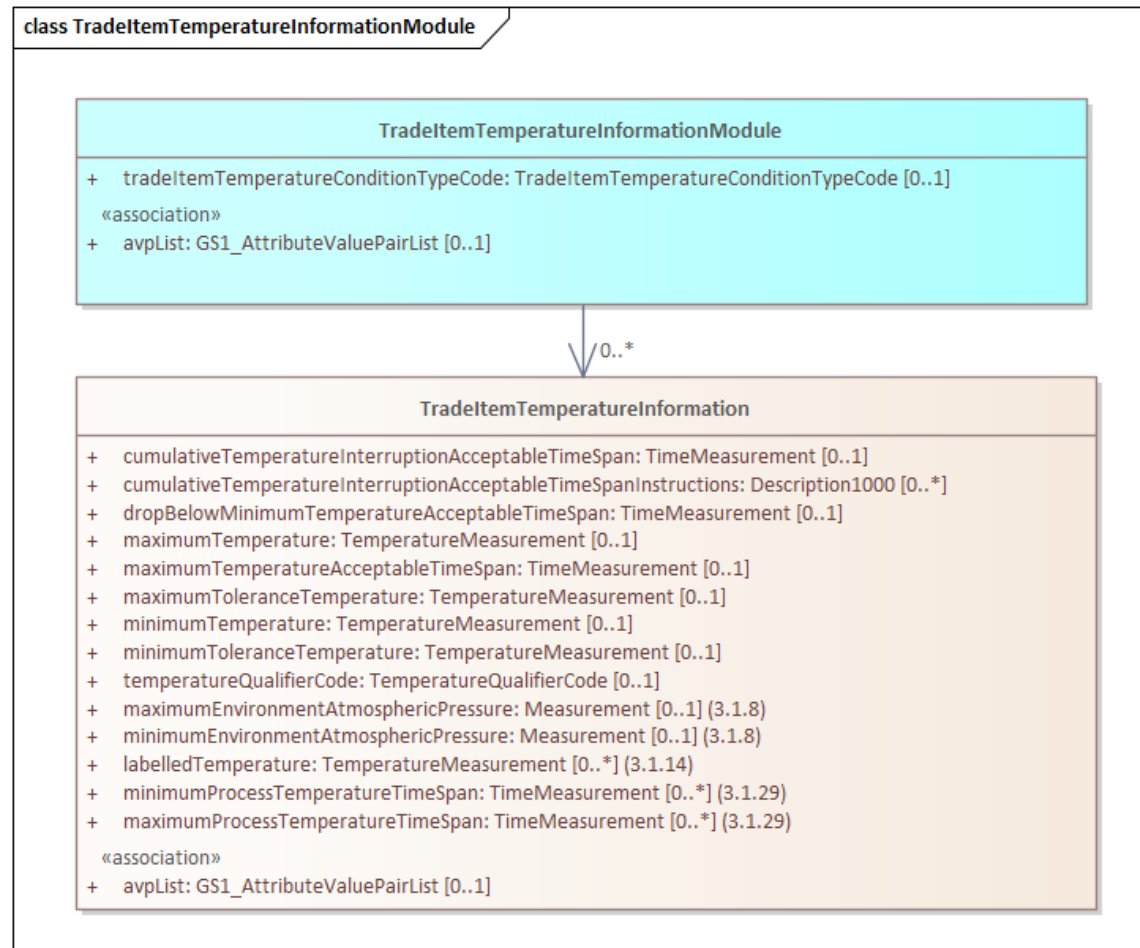



content	attribute / role	datatype /secondary class	multi licity	definition
TradeItemTemperatureInformationModule				Information on temperatures considerations for trade item.

content	attribute / role	datatype /secondary class	multipl icity	definition
Association		TradeItemTempera tureInformation	0..*	Details on permissible temperatures of a trade item during various points of the supply chain.
Association	avpList	GS1_AttributeValue PairList	0..1	Attribute value pair information.
Attribute	tradeItemTemperatur eConditionTypeCode	TradeItemTempera tureConditionTypeC ode	0..1	The condition of the product sold to the end consumer for example thawed or frozen.
TradeItemTemper atureInformation				Details on permissible temperatures of a trade item during various points of the supply chain.
Association	avpList	GS1_AttributeValue PairList	0..1	Attribute value pair information.
Attribute	cumulativeTemperatu reInterruptionAccepta bleTimeSpan	TimeMeasurement	0..1	An expression of the maximum allowed cumulative time span of one or more temperature interruptions of a trade item as defined by the manufacturer.
Attribute	cumulativeTemperatu reInterruptionAccepta bleTimeSpanInstru ctions	Description1000	0..*	Instructions provided by the product manufacturer regarding the process, procedures, or handling instructions for trade items that has exceeded the cumulative time span of temperature interruptions.
Attribute	dropBelowMinimumTe mperatureAcceptable TimeSpan	TimeMeasurement	0..1	The amount of time that a product can drop below the minimum temperature threshold during storage as defined by the manufacturer without affecting product safety or quality.
Attribute	labelledTemperature	TemperatureMeasu rement	0..*	The temperature(s) that is/are labelled on the trade item to help the consumer understand the temperatures for which the product can be used, e.g. the washing temperature(s) for a detergent.
Attribute	maximumEnvironmen tAtmosphericPressure	Measurement	0..1	The maximum atmospheric pressure in which the item remains usable. This value is the value above which the trade item should not be subjected.
Attribute	maximumProcessTem peratureTimeSpan	TimeMeasurement	0..*	The maximum amount of time that the product can safely be processed, relative to the process and temperature information provided by the manufacturer, without affecting product safety or quality.
Attribute	maximumTemperatur e	TemperatureMeasu rement	0..1	The maximum temperature that a trade item can not exceed as defined by the manufacturer without affecting product safety or quality.

content	attribute / role	datatype /secondary class	multiplicity	definition
Attribute	maximumTemperatureAcceptableTimeSpan	TimeMeasurement	0..1	The amount of time that a product can safely rise above the maximum temperature threshold during storage as defined by the manufacturer without affecting product safety or quality.
Attribute	maximumToleranceTemperature	TemperatureMeasurement	0..1	The maximum temperature at which the item is still usable. The tolerated temperature indicates that the temperature of the trade item should never rise above the maximum temperature.
Attribute	minimumEnvironmentAtmosphericPressure	Measurement	0..1	The minimum atmospheric pressure in which the item remains usable. This value is the value below which the trade item should not be subjected.
Attribute	minimumProcessTemperatureTimeSpan	TimeMeasurement	0..*	The minimum amount of time that the product is required to be processed, relative to the process and temperature information provided by the manufacturer, to ensure product safety or quality.
Attribute	minimumTemperature	TemperatureMeasurement	0..1	The minimum temperature that a trade item can be held below defined by the manufacturer without affecting product safety or quality.
Attribute	minimumToleranceTemperature	TemperatureMeasurement	0..1	The minimum temperature at which the item is still usable. The tolerated temperature indicates that the temperature of the trade item should never fall below the minimum temperature.
Attribute	temperatureQualifierCode	TemperatureQualifierCode	0..1	Code qualifying the type of a temperature requirement for example Storage.

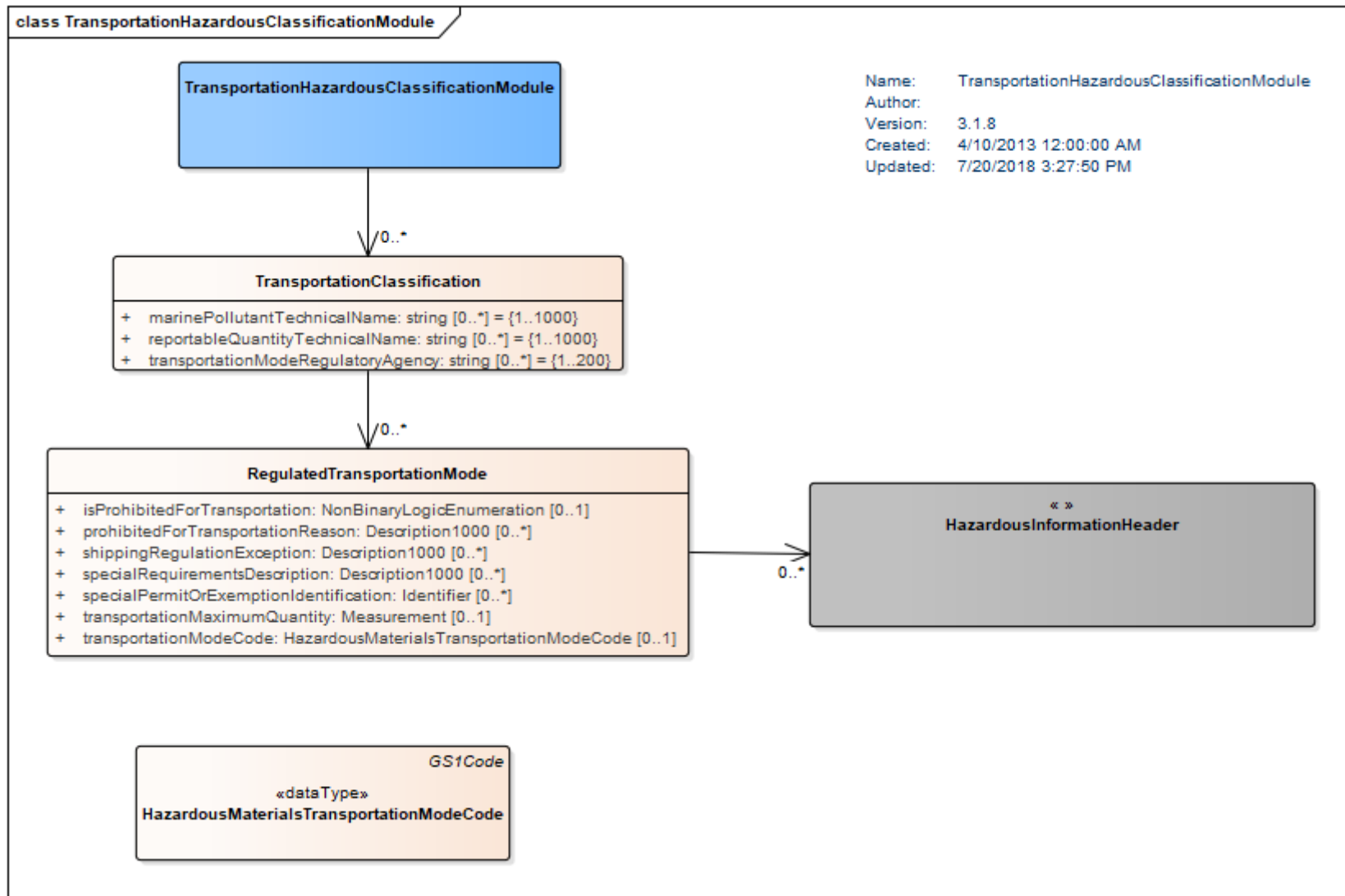
5.73 Transportation Hazardous Classification Module



 **Note:** Common class (in grey) is located in the GDSN Common Library.

Content	attribute / role	datatype /secondary class	multiplicity	definition
TransportationHazardousClassificationModule				A module containing information on hazardous information typically based on a specific mode of transportation as regulated by an agency for example ADR, IATA, DOT, IMDG.
Association		TransportationClassification	0..*	Information on hazardous information based on a specific mode of transportation as regulated by an agency for example ADR, IATA, DOT, IMDG.
TransportationClassification				Information on hazardous information based on a specific mode of transportation as regulated by an agency for example ADR, IATA, DOT, IMDG.
Association		RegulatedTransportationMode	0..*	Hazardous transportation information per mode of transportation.
Attribute	marinePollutantTechnicalName	string	0..*	The technical chemical name of any marine pollutant contained in the item or component.
Attribute	reportableQuantityTechnicalName	string	0..*	A recognized chemical name or microbiological name currently used in scientific and technical handbooks, journals, and texts for a chemical that exists in the Trade Item in quantity viewed as reportable according to a regulation for example US EPA.
Attribute	transportationModeRegulatoryAgency	string	0..*	The agency requiring information based on a specific mode of transportation for example ADR, IATA, DOT, IMDG.
RegulatedTransportationMode				Hazardous transportation information per mode of transportation.
Association		HazardousInformationHeader	0..*	Hazardous information for a hazardous class expressed for a transportation mode.
Attribute	isProhibitedForTransportation	NonBinaryLogicEnumeration	0..1	Indicates whether an item is prohibited for transportation via a specified mode.
Attribute	prohibitedForTransportationReason	Description1000	0..*	The reason that something is prohibited for transportation using a specific mode as a description.
Attribute	shippingRegulationException	Description1000	0..*	A description of any reasons for excluding a trade item or component from a hazardous regulation for a mode of transportation.

Content	attribute / role	datatype /secondary class	multiplicity	definition
Attribute	specialRequirementsDescription	Description1000	0..*	Any special requirements for storage or transportation in relation to any hazardous materials for example those regulated by ADR (European Agreement concerning the International Carriage of Dangerous Goods by Road).
Attribute	specialPermitOrExemptionIdentification	Identifier	0..*	An identifier (special permit number) for an exemption or special permit for a Trade Item. An identifier for an exception from a regulation specific to packaging for example DOT T, E, SP numbers, specialpermits for a packaging style.
Attribute	transportationMaximumQuantity	Measurement	0..1	The maximum inner volume of receptacles or packages (inner pack of vendor pack) that can be safely transported for a specific transportation type (e.g. Air Cargo) according to a governing agency.
Attribute	transportationModeCode	HazardousMaterialsTransportationModeCode	0..1	The type of vehicle used for the transportation of a hazardous material.

5.74 Variable Trade Item Information Module

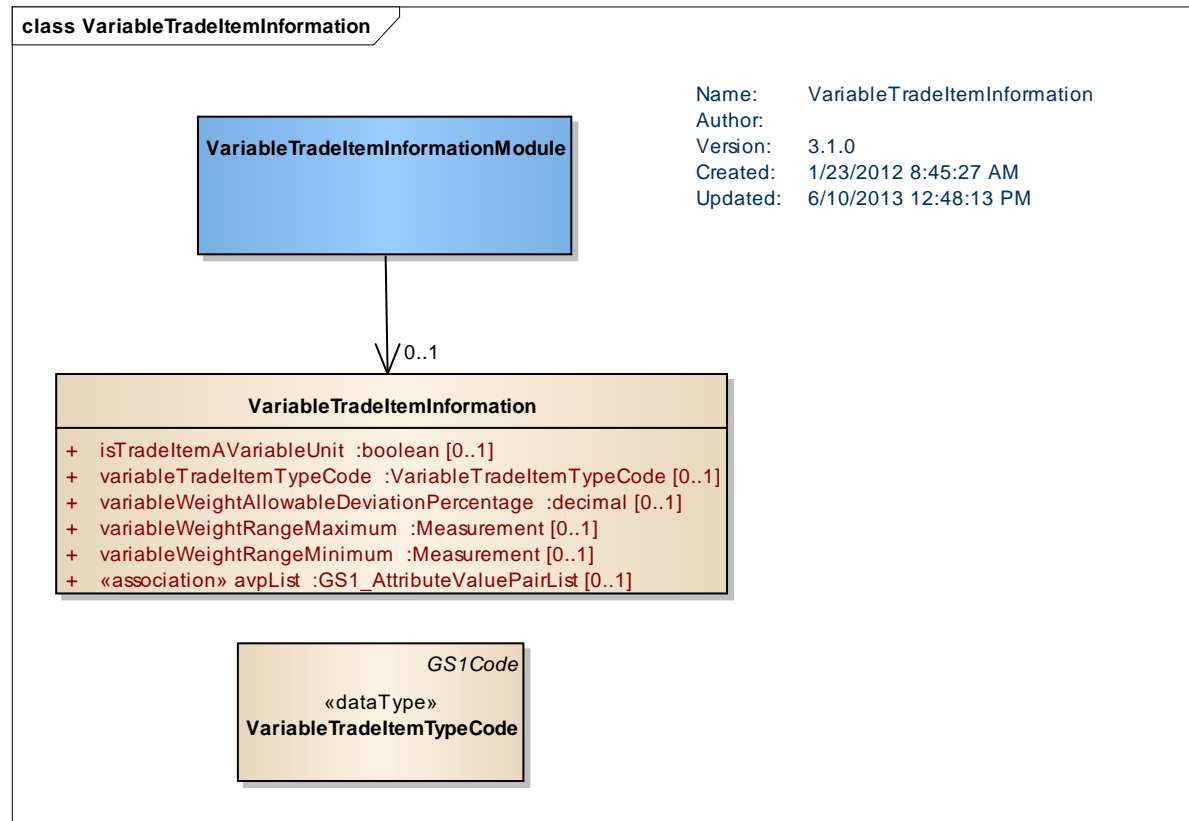

content	attribute / role	datatype /secondary class	multipl city	definition
VariableTradeItem Information				Information specific to variable weight or dimension trade items.
Association	avpList	GS1_AttributeValu ePairList	0..1	Attribute value pair information.

content	attribute / role	datatype /secondary class	multiplcity	definition
Attribute	isTradeItemAVariable Unit	boolean	0..1	Indicates that an article is not a fixed quantity, but that the quantity is variable. Can be weight, length, volume, trade item is used or traded in continuous rather than discrete quantities.
Attribute	variableTradeItemTy peCode	VariableTradeItem TypeCode	0..1	Indicator to show whether product is loose or pre-packed.
Attribute	variableWeightAllowa bleDeviationPercenta ge	decimal	0..1	Indication of the percentage value that the actual weight of the trade item may differ from the average or estimated weight given. For example, Roast beef off the bone 3.5 kg, Gross weight 3500 Grams, Range = 14 %. This means that this item may be produced with weight values ranging from 3.010 kg to 3.990 kg.
Attribute	variableWeightRange Maximum,	Measurement	0..1	Variable Weight Range Maximum (also called Catchweight Range Maximum) identifies the highest or ceiling weight of a variable weight product.
Attribute	variableWeightRange Minimum	Measurement	0..1	Variable Weight Range Minimum (also called Catch weight Range Minimum) identifies the lowest weight of the variable weight product.
VariableTradeItem InformationModul e				A module containing information specific to variable weight or dimension trade items.
Association		VariableTradeItemI nformation	0..1	Information specific to variable weight or dimension trade items.

5.75 Video Display Device Information Module

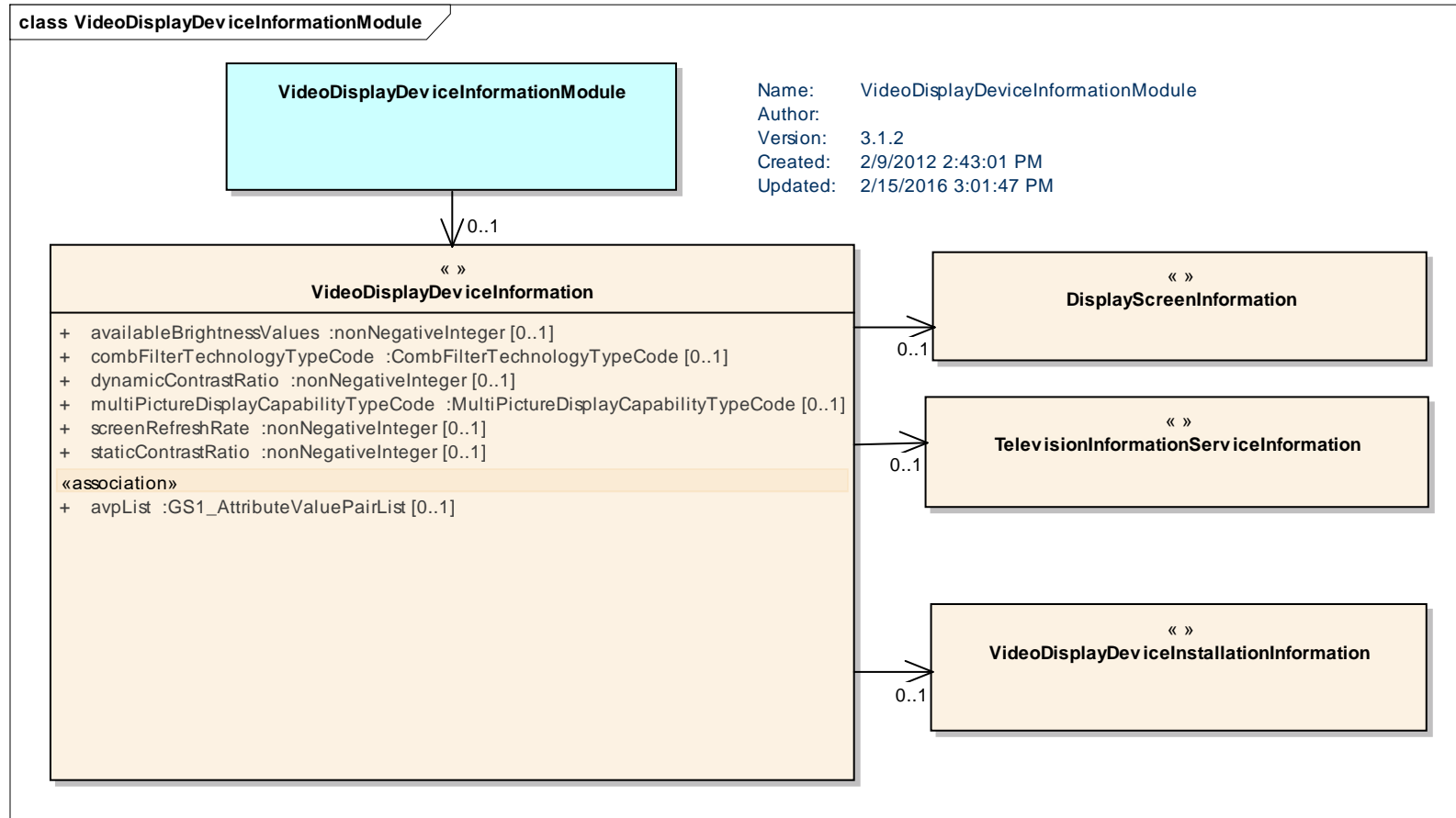

content	attribute / role	datatype /secondary class	multiplcity	definition
TelevisionInformationServiceInformation				A capability of the television to process text information service (subtitled or captioned) for example Teletext, Telidon, Antiope, Fasttext.

content	attribute / role	datatype /secondary class	multiplcity	definition
Attribute	televisionInformationServiceTypeCode	TelevisionInformationServiceTypeCode	0..*	The type of text information services the unit can process expressed as a code for example ANTIOPE.
Attribute	televisionTextMemoryPageQuantity	nonNegativeInteger	0..1	This is the quantity of pages expressed as an integer that the television memory maintains for previously viewed Teletext content.
VideoDisplayDeviceInstallationInformation				Installation information for a audio visual item.
Attribute	audioVisualItemInstallationOptionTypeCode	AudioVisualItemInstallationTypeCode	0..1	The way that the unit can be mounted or placed expressed as a code for example CEILING_MOUNT.
Attribute	vESAWallMountTypeCode	VESAWallMountTypeCode	0..1	The type of VESA wall mount the television is compatible with. VESA is a standard bracket which is a universal mount measured by the Video Electronic Standard Association.
VideoDisplayDeviceInformation				Information of the video capabilities of the trade item.
Association		TelevisionInformationServiceInformation	0..1	A capability of the television to process text information service (subtitled or captioned) for example Teletext, Telidon, Antiope, Fasttext.
Association		VideoDisplayDeviceInstallationInformation	0..1	Installation information for a audio visual item.
Association		DisplayScreenInformation	0..1	Details on television or monitor screens for a trade item.
Association	avpList	GS1_AttributeValuePairList	0..1	Attribute value pair information.
Attribute	availableBrightnessValues	nonNegativeInteger	0..1	The monitor brightness as a measurement. This is measured in candela per square meter (also known as Nits) or lumens per square meter, and Lux.
Attribute	combFilterTechnologyTypeCode	CombFilterTechnologyTypeCode	0..1	A code depiction the type of software allowing the screen to show fine picture detail from channel broadcast or DVD source for example DIGITAL.

content	attribute / role	datatype /secondary class	multiplcity	definition
Attribute	dynamicContrastRatio	nonNegativeInteger	0..1	This is the ratio of luminosity of the brightest and darkest colour the system is capable of producing simultaneously over time. In the attribute the integer given is the first number in the ratio which is always to one, i.e. 550:1.
Attribute	multiPictureDisplayCapabilityTypeCode	MultiPictureDisplayCapabilityTypeCode	0..1	The type of ability to simultaneously display multiple viewing windows on the same screen expressed as a code for example PICTURE_AND_TEXT.
Attribute	screenRefreshRate	nonNegativeInteger	0..1	This is defined as the number of times a display's image is repainted or refreshed in per second measured in Hertz.
Attribute	staticContrastRatio	nonNegativeInteger	0..1	This is the ratio of luminosity of the brightest and darkest colour the system is capable of producing simultaneously at any instance of time. In the attribute the integer given is the first number in the ratio which is always to one, i.e. 550:1.
VideoDisplayDeviceInformationModule				A module containing Information of the capabilities of a trade item that displays visual images for example a television or a computer monitor.
Association		VideoDisplayDeviceInformation	0..1	Information of the video capabilities of the trade item.

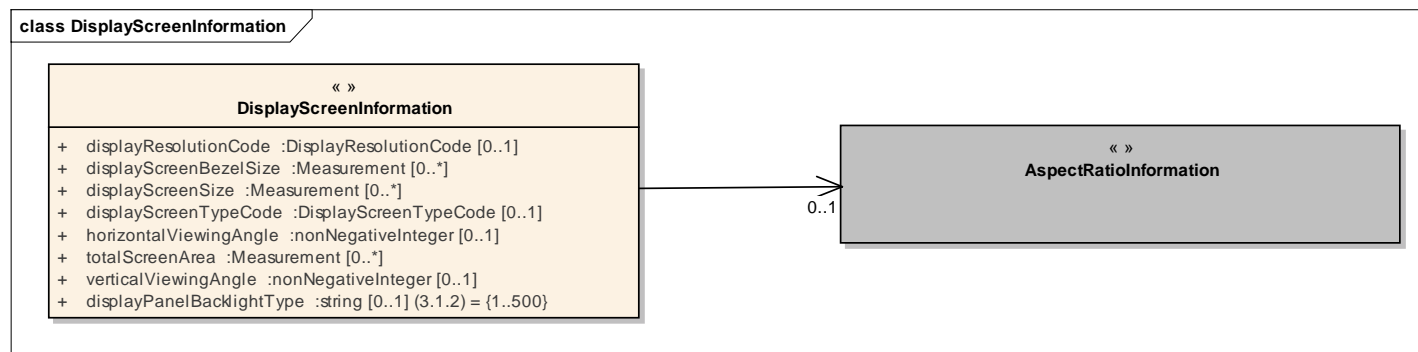

content	attribute / role	datatype /secondary class	multiplcity	definition
DisplayScreenInformation				Details on television or monitor screens for a trade item.

content	attribute / role	datatype /secondary class	multipl city	definition
Association		AspectRatioInform ation	0..1	Aspect ratio information for a display screen.
Attribute	displayPanelBacklight Type	String	0..1	The backlighting utilized in the panel, most commonly Cold Cathode Fluorescent Lamps (CCFLs) or Light Emitting Diodes (LEDs).
Attribute	displayResolutionCod e	DisplayResolutionC ode	0..1	The code that describes the display resolution of the product. This typically refers to the number of distinct pixels in each dimension that can be displayed, for example 720x480, 1680x1050, etc.
Attribute	displayScreenBezelSi ze	Measurement	0..*	The measurement from the edge of physical screen to the frame.
Attribute	displayScreenSize	Measurement	0..*	The viewable display/screen size of the product expressed as a measurement (inches or centimetres).
Attribute	displayScreenTypeCo de	DisplayScreenType Code	0..1	The type of output device for presentation of visual information.
Attribute	horizontalViewingAng le	nonNegativeIntege r	0..1	The maximum angle that a picture can be viewed without distortion in the horizontal orientation expressed in degrees.
Attribute	totalScreenArea	Measurement	0..*	The area of a television or monitor screen typically measured as viewable screen height by viewable screen width.
Attribute	verticalViewingAngle	nonNegativeIntege r	0..1	The maximum angle that a picture can be viewed without distortion in the vertical orientation expressed in degrees.

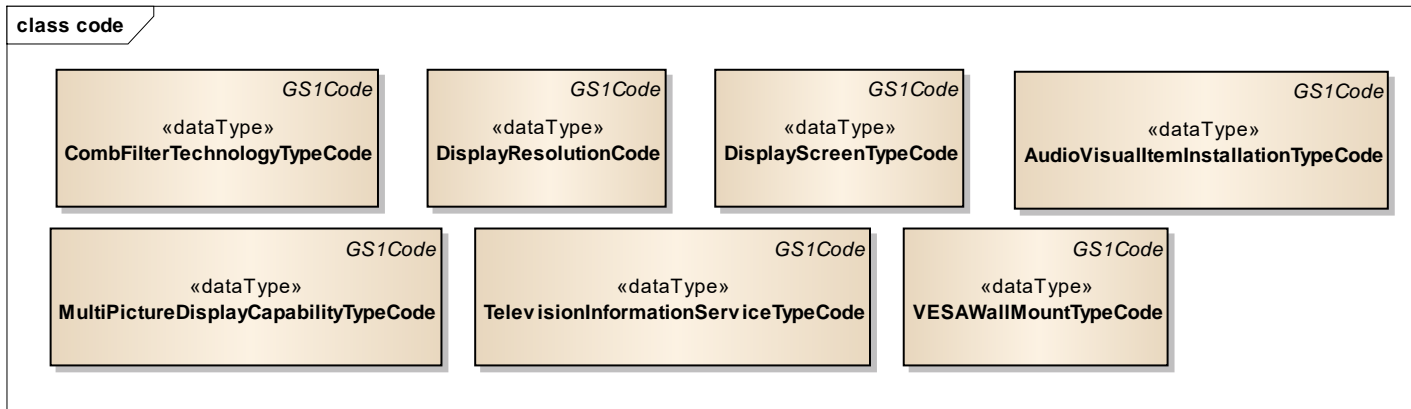

5.76 Warranty Information Module

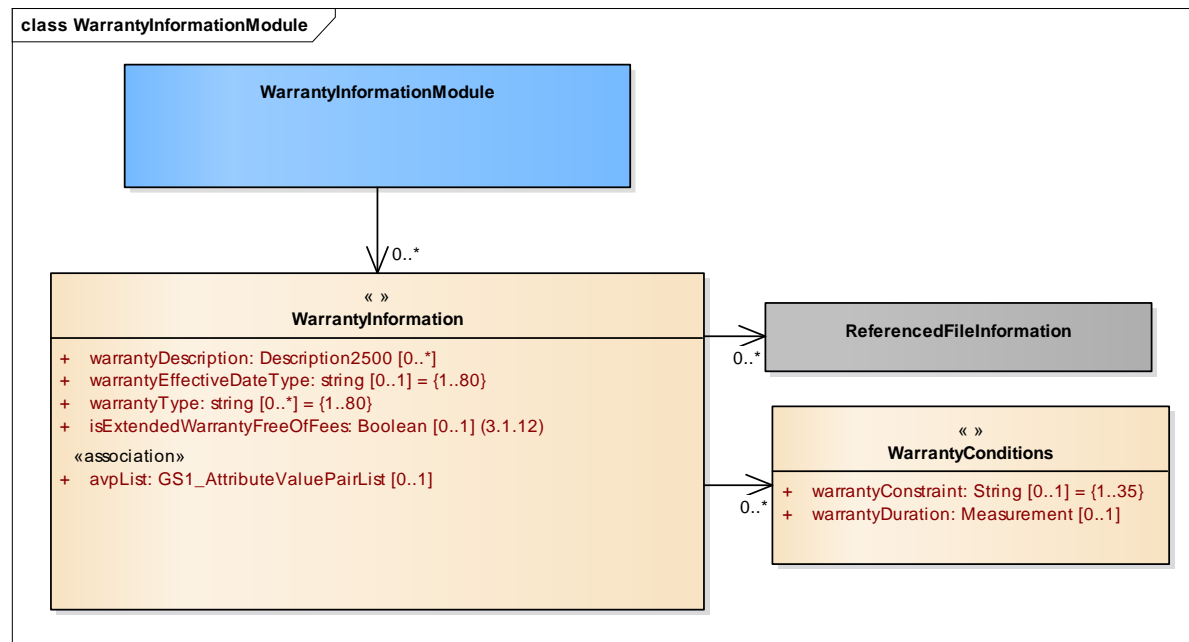

content	attribute / role	datatype /secondary class	multipl city	definition
WarrantyConditio ns				Provides information on the usually written guarantee of the integrity of a product and of the maker's responsibility for the repair or replacement of defective parts.
Attribute	warrantyConstraint	string	0..1	Determines the relationship between multiple warranty conditions for example "and", "or", "greatest", "least".
Attribute	warrantyDuration	Measurement	0..1	The time period that the warranty is valid within.
WarrantyInformat ion				An assurance that the trade item is reliable and that repairs or replacement will be done free of charge within a given time limit and under certain conditions in the event of a defect.
Association		ReferencedFileInfor mation	0..*	External file information for a warranty.
Association		WarrantyConditio ns	0..*	Warranty Conditions for this Trade Item Warranty.
Association	avpList	GS1_AttributeValu ePairList	0..1	Attribute value pair information.
Attribute	warrantyDescription	Description2500	0..*	The description of warranty available for the trade item.
Attribute	warrantyEffectiveDat eType	String {1..80}	0..1	The type of date associated with the warranty trade item usually expressed as an event date for the item for example date of purchase, date of manufacture or date of delivery. Utilizes WarrantyEffectiveDateTypeCode list (See Section 6.2).
Attribute	warrantyType	String {1..80}	0..*	The type of warranty available for the trade item for example labour, distance, extended service. Utilizes WarrantyTypeCode list (See Section 6.2).
Attribute	isExtendedWarrantyF reeOfFees	Boolean	0..1	Used to inform the recipient if the extended warranty is or is not free of fees.
WarrantyInformat ionModule				An assurance that the trade item is reliable and that repairs or replacement will be done free of charge within a given time limit and under certain conditions in the event of a defect.
Association		WarrantyInformati on	0..*	A module containing any warranty information relevant to a trade item.

6 Codes

6.1 GS1 Managed Codes

All GS1 managed codes applicable to GDSN can be found at the following link:

[GDSN Code List BMS](#)

6.2 Attributes with Code Lists Not Specified in Models

The following attributes do not specify the code list to be used using the data type. The following table lists the code lists to be used for these types of attributes.

Attribute Name	Code List
classOfDangerousGoods	Recommend to use codes listed in the UN Recommendations on the Transport of Dangerous Goods.
animalCutCode	Based on animalCutCode use the following: <ul style="list-style-type: none"> meatCutCode poultryCutCode
colourCodeListCode	Use ColourCodeListCode
codeListNameCode	AVPCodeListNameCode (GS1 Code List)
countryCode	GDSN extends the ISO Country Code list with the value NON_EU. The Country Code List for GDSN is in this document.
dangerousGoodsRegulationCode	DangerousGoodsRegulationCode
epubUsageStatus	ONIXUsageStatusCode
epubUsageType	ONIXUsageTypeCode
genreTypeCodeReference	GS1 Code List used differs based on product: <ul style="list-style-type: none"> Product Genre Type Code (Electronic Games) Product Genre Type Code (Film) Product Genre Type Code (Music)
handlingInstructionsCodeReference	Use HandlingInstructionsCode_GDSN in Code List BMS to populate.
massEquivalentProtocolCode	Based On MassEquivalentCode, use one of following: <ul style="list-style-type: none"> Mass Equivalent Fresh Water Consumption Protocol Code Mass Equivalent Ionizing Radiation Human Protocol Code Mass Equivalent Land Use Protocol Code Mass Equivalent Nonrenewable Resource Depletion Protocol Code Mass Equivalent Ozone Depletion Protocol Code Mass Equivalent Particulate Respiratory Effects Protocol Code Mass Equivalent Photochemical Ozone Creation Potential Protocol Code

Attribute Name	Code List
massEquivalentSubstanceCodeReference	Based On MassEquivalentCode, use one of following: <ul style="list-style-type: none"> • Mass Equivalent Fresh Water Consumption Substance Code • Mass Equivalent Ionizing Radiation Human Substance Code • Mass Equivalent Land Use Substance Code • Mass Equivalent Non Renewable Resource Depletion Substance Code • Mass Equivalent Ozone Depletion Reference Substance Code • Mass Equivalent Particulate Respiratory Effects Reference Substance Code
materialCode	Code List used differs based on Product Type: <ul style="list-style-type: none"> • materialCode (Lining) • materialCode (Heel)
onixExtentUnitTypeCode	Recommended to use ONIX List 24: Extent Unit Code.
ONIXProductAvailabilityCode	Recommended to use ONIX List 65
opacityTypeCode	A code to describe the opacity achieved by the product. The codes may vary by product type: <ul style="list-style-type: none"> • OpacityTypeCode(Cosmetics)
productActivityRegionZoneCodeReference	Use CatchAreaCode when productActivityType = CATCH_ZONE
physicalResourceUsageRatingScaleCodeReference	The value in a range or scale of efficiency of the product is rated, for example, spectrum A - G.
ratingContentDescriptorCode	GS1 Code List used differs based on product: <ul style="list-style-type: none"> • Rating Content Descriptor Code (Music) • Rating Content Descriptor Code (ESBR) • Rating Content Descriptor Code (PEGI) • Rating Content Descriptor Code (Film)
regulationLevelCodeReference	An external code associated with a specific warning type and possibly a description that helps recipients identify items of similar levels of warnings, that cannot be obtained from a description.
rOHSComplianceFailureMaterial	Use ROHSComplianceFailureMaterialCode.
sizeCodeListCode	Use SizeCodeListCode.
titleRatingCodeReference	GS1 Code List used differs based on product type: <ul style="list-style-type: none"> • Title Rating Code (Games) • Title Rating Code (Film).
unnamedPersons	onixUnnamedPersonsCode
unitedNationsDangerousGoodsNumber	UNDG Number: Recommend to use codes listed in the 16 th edition of the UN Recommendations on the Transport of Dangerous Goods was published in 2009.
warrantyEffectiveDateType	WarrantyEffectiveDateTypeCode
warrantyType	WarrantyTypeCode
dietTypeSubcode	DietTypeSubcode
chemicalIngredientScheme	Use Global LCL. See under GS1 Global Office section for the LCL.
grapeVarietyCode	The source of this code list is the code list of the GPC Attribute 20000081 "Grape Variety"

7 Implementation Considerations

7.1 Attribute Variations

Last two columns are used strictly for attributes with Languages, Measurements and Currencies

Attribute Name	Target Market Applicability	Trading Partner Neutral status	Multiple Values (Grey = N/A)	Multi Language/ Measurement / Currency
acceleration	Global/Local	T.P.Neutral	Yes	Yes
accidentalReleaseMeasuresDescription	Global/Local	T.P.Neutral	No	Yes
acidificationMeasurement	Global/Local	T.P.Neutral	No	No
acidificationMeasurementProtocolCode	Global/Local	T.P.Neutral		
acidificationMeasurementProtocolDescription	Global/Local	T.P.Neutral	No	Yes
acidificationMeasurementReferenceSubstanceCode	Global/Local	T.P.Neutral		
acidificationMeasurementReferenceSubstanceDescription	Global/Local	T.P.Neutral	No	Yes
additionalCameraAngleCode	Global/Local	T.P.Neutral		
additionalCertificationOrganisationIdentifier	Global/Local	T.P.Neutral		
additionalPartyIdentification	Global/Local	T.P.Neutral & T.P.Dependent		
additionalSDSInformation	Global/Local	T.P.Neutral	No	Yes
additionalTradeItemClassificationCodeDescription	Global/Local	T.P.Neutral	No	Yes
additionalTradeItemClassificationCodeSequenceNumber	Global/Local	T.P.Neutral		
additionalTradeItemClassificationCodeValue	Global/Local	T.P.Neutral		
additionalTradeItemClassificationPropertyCode	Global/Local	T.P.Neutral		
additionalTradeItemClassificationPropertyDescription	Global/Local	T.P.Neutral	No	Yes
additionalTradeItemClassificationSystemCode	Global/Local	T.P.Neutral		
additionalTradeItemClassificationVersion	Global/Local	T.P.Neutral		
additionalTradeItemDescription	Global/Local	T.P.Neutral	No	Yes
additionalTradeItemIdentification	Global/Local	T.P.Neutral & T.P.Dependent		
additiveName	Global/Local	T.P.Neutral		
additiveStatement	Global/Local	T.P.Neutral	No	Yes
additiveTypeCodeReference	Global/Local	T.P.Neutral		
aDRDangerousGoodsLimitedQuantitiesCode	Global/Local	T.P.Neutral		
aDRDangerousGoodsPackagingTypeCode	Global/Local	T.P.Neutral		
aDRTunnelRestrictionCode	Global/Local	T.P.Neutral		
ageRangeDescription	Global/Local	T.P.Neutral	No	Yes
agreedMaximumBuyingQuantity	Global/Local	T.P.Neutral		
agreedMinimumBuyingQuantity	Global/Local	T.P.Neutral		
alcoholBeverageAge	Global/Local	T.P.Neutral	No	Yes
alcoholicBeverageColourCode	Global/Local	T.P.Neutral & T.P.Dependent		
alcoholBeverageDistilledFromCode	Global/Local	T.P.Neutral		
alcoholBeverageFilteringMethodTypeCode	Global/Local	T.P.Neutral		
alcoholBeverageProductionMethodTypeCode	Global/Local	T.P.Neutral		
alcoholBeverageTypeCode	Global/Local	T.P.Neutral		
alcoholicBeverageSubregion	Global/Local	T.P.Neutral		
alcoholicBeverageSugarContent	Global/Local	T.P.Neutral	No	Yes
alcoholicPermissionLevel	Global/Local	T.P.Neutral		
alcoholProof	Global/Local	T.P.Neutral		

Attribute Name	Target Market Applicability	Trading Partner Neutral status	Multiple Values (Grey = N/A)	Multi Language/ Measurement / Currency
alcoholUnits	Global/Local	T.P.Neutral		
allergenRelevantDataProvidedDateTime	Global/Local	T.P.Neutral & T.P.Dependent		
allergenSpecificationAgency	Global/Local	T.P.Neutral		
allergenSpecificationName	Global/Local	T.P.Neutral		
allergenStatement	Global/Local	T.P.Neutral	No	Yes
allergenTypeCode	Global/Local	T.P.Neutral		
allowanceChargeAmount	Global/Local	T.P.Neutral & T.P.Dependent	No	No
allowanceChargeDescription	Global/Local	T.P.Neutral & T.P.Dependent	No	Yes
allowanceChargePercentage	Global/Local	T.P.Neutral & T.P.Dependent		
allowanceChargeTypeCode	Global/Local	T.P.Neutral & T.P.Dependent		
allowanceOrChargeType	Global/Local	T.P.Neutral & T.P.Dependent		
alternativeName	Global/Local	T.P.Neutral		
alternativeNameType	Global/Local	T.P.Neutral		
alternativeReturnableAssetIdentification	Global/Local	T.P.Neutral		
alternateText	Global/Local	T.P.Neutral	No	Yes
amountPerUnit	Global/Local	T.P.Neutral	No	No
animalCutCode	Global/Local	T.P.Neutral & T.P.Dependent		
animalFeedingDescriptionOnANutrient	Global/Local	T.P.Neutral	Yes	Yes
animalFeedingDescriptionOnNutrientQualifier	Global/Local	T.P.Neutral		
animalFoodProcessOrStateTypeCode	Global/Local	T.P.Neutral		
animalFoodTypeCode	Global/Local	T.P.Neutral		
animalNutrientExactPercentage	Global/Local	T.P.Neutral		
animalNutrientMaximumPercentage	Global/Local	T.P.Neutral		
animalNutrientMinimumPercentage	Global/Local	T.P.Neutral		
animalNutrientQuantityContained	Global/Local	T.P.Neutral	No	Yes
animalNutrientQuantityContainedBasis	Global/Local	T.P.Neutral	No	Yes
animalNutrientTypeCode	Global/Local	T.P.Neutral		
animalNutritionalClaim	Global/Local	T.P.Neutral	Yes	Yes
animalTargetBreed	Global/Local	T.P.Neutral	Yes	Yes
animalTargetedHealthConditionCode	Global/Local	T.P.Neutral		
animalTargetSizeCode	Global/Local	T.P.Neutral		
annexXVIintendedPurposeTypeCode	Global/Local	T.P.Neutral		
apparelDetailApplicationCode	Global/Local	T.P.Neutral		
apparelDetailPlacementCode	Global/Local	T.P.Neutral		
apparelDetailSizeCode	Global/Local	T.P.Neutral		
apparelDetailTypeCode	Global/Local	T.P.Neutral		
applicationIdentifierTypeCode	Global/Local	T.P.Neutral		
aquaticEutrophicationMeasurement	Global/Local	T.P.Neutral	No	No
aquaticEutrophicationModelCode	Global/Local	T.P.Neutral		
aquaticEutrophicationModelDescription	Global/Local	T.P.Neutral	No	Yes
aquaticEutrophicationReferenceSubstanceCode	Global/Local	T.P.Neutral		
aquaticEutrophicationReferenceSubstanceDescription	Global/Local	T.P.Neutral	No	Yes
aquaticEutrophicationWaterBodyDescription	Global/Local	T.P.Neutral	No	Yes
aquaticEutrophicationWaterBodyTypeCode	Global/Local	T.P.Neutral		

Attribute Name	Target Market Applicability	Trading Partner Neutral status	Multiple Values (Grey = N/A)	Multi Language/ Measurement / Currency
areBatteriesBuiltIn	Global/Local	T.P.Neutral		
areBatteriesIncluded	Global/Local	T.P.Neutral		
areBatteriesRequired	Global/Local	T.P.Neutral		
areFeesRequiredForUse	Global/Local	T.P.Neutral		
areHazardousComponentsRemovable	Global	T.P.Neutral		
areHumanModelsInFile	Global/Local	T.P.Neutral		
aspectRatioDescriptionCode	Global/Local	T.P.Neutral		
aspectRatioDimensionCode	Global/Local	T.P.Neutral		
audienceCodeValueCode	Global/Local	T.P.Neutral		
audienceDescription	Global/Local	T.P.Neutral	No	Yes
audienceRangePrecision1Code	Global/Local	T.P.Neutral		
audienceRangePrecision2Code	Global/Local	T.P.Neutral		
audienceRangeQualifierCode	Global/Local	T.P.Neutral		
audienceRangeValue1	Global/Local	T.P.Neutral		
audienceRangeValue2	Global/Local	T.P.Neutral		
audienceTypeCodeListCode	Global/Local	T.P.Neutral		
audioSoundTypeCode	Global/Local	T.P.Neutral		
audioVisualConnectionInputDirectionCode	Global/Local	T.P.Neutral		
audioVisualConnectionLocationCode	Global/Local	T.P.Neutral		
audioVisualConnectionQuantity	Global/Local	T.P.Neutral		
audioVisualConnectionTypeCode	Global/Local	T.P.Neutral		
audioVisualItemInstallationOptionTypeCode	Global/Local	T.P.Neutral		
audioVisualMediaDateTime	Global/Local	T.P.Neutral		
audioVisualMediaDateTypeCode	Global/Local	T.P.Neutral		
audioVisualMediaItemContributorName	Global/Local	T.P.Neutral		
audioVisualMediaItemContributorTypeCode	Global/Local	T.P.Neutral		
audioVisualMediaProductCollectionName	Global/Local	T.P.Neutral		
audioVisualMediaProductCollectionSeriesNumber	Global/Local	T.P.Neutral		
audioVisualMediaProductLabelName	Global/Local	T.P.Neutral		
audioVisualMediaProductLine	Global/Local	T.P.Neutral	Yes	Yes
audioVisualMediaProductTitle	Global/Local	T.P.Neutral		
autographedBy	Global/Local	T.P.Neutral		
autoIgnitionTemperature	Global/Local	T.P.Neutral	No	Yes
automaticPowerDownDefaultTimePeriod	Global	T.P.Neutral		
availableBrightnessValues	Global/Local	T.P.Neutral		
availableChannelStationQuantity	Global/Local	T.P.Neutral		
availableLanguageCode	Global/Local	T.P.Neutral		
availableTime	Global/Local	T.P.Neutral	No	Yes
averageDistanceTravelledToPointOfPackagingCode	Global/Local	T.P.Neutral		
awardPrizeCode	Global/Local	T.P.Neutral		
awardPrizeCountryCode	Global/Local	T.P.Neutral		
awardPrizeDescription	Global/Local	T.P.Neutral	No	Yes
awardPrizeJury	Global/Local	T.P.Neutral		
awardPrizeName	Global/Local	T.P.Neutral		
awardPrizeYear	Global/Local	T.P.Neutral		
baseAmount	Global/Local	T.P.Neutral	No	No
baseNumberOfUnits	Global/Local	T.P.Neutral	No	No
batteryCapacity	Global/Local	T.P.Neutral	No	Yes



Attribute Name	Target Market Applicability	Trading Partner Neutral status	Multiple Values (Grey = N/A)	Multi Language/ Measurement / Currency
batteryDeviceCompatibilityStatement	Global/Local	T.P.Neutral	No	Yes
batteryTechnologyTypeCode	Global/Local	T.P.Neutral		
batteryTypeCode	Global/Local	T.P.Neutral		
batteryTypeQualifierCode	Global/Local	T.P.Neutral		
batteryVoltage	Global/Local	T.P.Neutral	No	Yes
batteryWattHourRating	Global/Local	T.P.Neutral		
batteryWeight	Global/Local	T.P.Neutral	No	No
perfumeFragranceDilutionClassCode	Global/Local	T.P.Neutral		
beerStyleCode	Global/Local	T.P.Neutral	No	No
bendAngleCode	Global/Local	T.P.Neutral		
biographicalNote	Global/Local	T.P.Neutral	No	Yes
boilingPoint	Global/Local	T.P.Neutral	No	Yes
bioengineeredDeclarationClaimCode	Global/Local	T.P.Neutral		
bitternessOfBeerMeasurement	Global/Local	T.P.Neutral & T.P.Dependent	No	Yes
boxOfficeRevenueDomestic	Global/Local	T.P.Neutral	No	No
boxOfficeRevenueFirstWeekDomestic	Global/Local	T.P.Neutral	No	No
boxOfficeRevenueUS	Global/Local	T.P.Neutral	No	No
boxOfficeRevenueWorldwideUSDollars	Global/Local	T.P.Neutral	No	No
brandDistributionTradeItemTypeCode	Global/Local	T.P.Neutral & T.P.Dependent	Yes	No
brandDistributionTypeCode	Global/Local	T.P.Neutral		
brandMarketingDescription	Global/Local	T.P.Neutral	Yes	Yes
brandName	Global	T.P.Neutral		
brandOwner	Global	T.P.Neutral		
bristleHardnessCode	Global/Local	T.P.Neutral		
brushBroomTypeCode	Global/Local	T.P.Neutral & T.P.Dependent		
builtInProductType	Global	T.P.Neutral		
campaignEndDateTime	Global	T.P.Neutral		
campaignMediaTypeDescription	Global/Local	T.P.Neutral	Yes	Yes
campaignName	Global	T.P.Neutral	No	Yes
campaignStartDateTime	Global	T.P.Neutral		
cancelledDateTime	Global	T.P.Neutral		
canFilesBeEdited	Global/Local	T.P.Neutral		
canFileStream	Global/Local	T.P.Neutral		
cannabisCBDTypeCode	Global/Local	T.P.Neutral		
cannabinoidContentCode	Global/Local	T.P.Neutral & T.P.Dependent		
cannabinoidMaximumRangeValue	Global/Local	T.P.Neutral & T.P.Dependent	No	No
cannabinoidMinimumRangeValue	Global/Local	T.P.Neutral & T.P.Dependent	No	No
cannabinoidTypeCode	Global/Local	T.P.Neutral & T.P.Dependent		
cannabisCommonName	Global/Local	T.P.Neutral & T.P.Dependent	No	Yes
cannabisPlantTypeCode	Global/Local	T.P.Neutral & T.P.Dependent		
canMaterialsBeSeparatedManually	Global/Local	T.P.Neutral & T.P.Dependent		
canTradeItemBeBackOrdered	Global/Local	T.P.Neutral		
carcinogenicMutagenicReprotoxicTypeCode	Global/Local	T.P.Neutral & T.P.Dependent		
cardPriceGroupIdentifier	Global/Local	T.P.Neutral		

Attribute Name	Target Market Applicability	Trading Partner Neutral status	Multiple Values (Grey = N/A)	Multi Language/ Measurement / Currency
carrierSubstanceTypeCode	Global/Local	T.P.Neutral		
cartridgeDeviceCompatibilityCode	Global/Local	T.P.Neutral		
caseDescription	Global/Local	T.P.Neutral	No	Yes
casingTareWeight	Global	T.P.Neutral	No	No
cataloguePrice	Global/Local	T.P.Neutral	No	No
catchAreaCode	Global/Local	T.P.Neutral		
catchCountryCode	Global/Local	T.P.Neutral	Yes	No
catchDateTime	Global/Local	T.P.Neutral		
catchMethodCode	Global/Local	T.P.Neutral		
certificateIssuanceDateTime	Global/Local	T.P.Neutral		
certificationAgency	Global/Local	T.P.Neutral		
certificationAssessmentDateTime	Global/Local	T.P.Neutral		
certificationEffectiveEndDateTime	Global/Local	T.P.Neutral		
certificationEffectiveStartDateTime	Global/Local	T.P.Neutral		
certificationExecutionCountryCode	Global/Local	T.P.Neutral & T.P.Dependent		
certificationIdentification	Global/Local	T.P.Neutral		
certificationStatementOnPackage	Global/Local	T.P.Neutral	Yes	Yes
certificationOrganisationIdentifier	Global/Local	T.P.Neutral		
certificationStandard	Global/Local	T.P.Neutral		
certificationValue	Global/Local	T.P.Neutral		
cfpAccountingCode	Global/Local	T.P.Neutral & T.P.Dependent		
cfpCountryCode	Global/Local	T.P.Neutral & T.P.Dependent		
cfpDate	Global/Local	T.P.Neutral & T.P.Dependent	No	No
cfpBoundariesCode	Global/Local	T.P.Neutral & T.P.Dependent		
cfpFunctionalUnit	Global/Local	T.P.Neutral & T.P.Dependent	Yes	Yes
cfpMethodologyCode	Global/Local	T.P.Neutral & T.P.Dependent		
cfpValue	Global/Local	T.P.Neutral & T.P.Dependent	Yes	Yes
cfpValueVerificationCode	Global/Local	T.P.Neutral & T.P.Dependent		
channelSpecificMarketingMessage	Global/Local	T.P.Neutral & T.P.Dependent	Yes	Yes
channelSpecificShortMarketingMessage	Global/Local	T.P.Neutral & T.P.Dependent	Yes	Yes
cheeseMaturationPeriodDescription	Global/Local	T.P.Neutral	No	Yes
cheeseMaturationProcessContainerTypeCode	Global/Local	T.P.Neutral		
cheeseMilkAcquisitionTypeCode	Global	T.P.Neutral		
cheeseMoisturePercentage	Global/Local	T.P.Neutral		
cheeseRipeningProcessCode	Global/Local	T.P.Neutral		
cheeseTypeCode	Global	T.P.Neutral & T.P.Dependent	Yes	No
chemicalIngredientConcentration	Global/Local	T.P.Neutral	No	No
chemicalIngredientConcentrationBasis	Global/Local	T.P.Neutral	No	No
chemicalIngredientConcentrationLowerValue	Global/Local	T.P.Neutral		
chemicalIngredientConcentrationMeasurementPrecision	Global/Local	T.P.Neutral		
chemicalIngredientConcentrationUpperValue	Global/Local	T.P.Neutral		
chemicalIngredientIdentification	Global/Local	T.P.Neutral		
chemicalIngredientName	Global/Local	T.P.Neutral		

Attribute Name	Target Market Applicability	Trading Partner Neutral status	Multiple Values (Grey = N/A)	Multi Language/ Measurement / Currency
chemicalIngredientOrganisation	Global/Local	T.P.Neutral		
chemicalIngredientScheme	Global/Local	T.P.Neutral		
chemicalPhysicalStateCode	Global/Local	T.P.Neutral		
chemicalPropertyAdditionalDescription	Global/Local	T.P.Neutral	No	Yes
chemicalPropertyCode	Global/Local	T.P.Neutral		
chemicalPropertyName	Global/Local	T.P.Neutral		
chemicalPropertyTypeCode	Global/Local	T.P.Neutral		
chemicalRegulationAgency	Global/Local	T.P.Neutral		
chemicalRegulationName	Global/Local	T.P.Neutral		
childNutritionExpirationDateTime	Global/Local	T.P.Neutral		
childNutritionLabelStatement	Global/Local	T.P.Neutral	Yes	Yes
childNutritionProductIdentification	Global/Local	T.P.Neutral		
childNutritionQualifiedValue	Global/Local	T.P.Neutral	No	Yes
childNutritionQualifierCode	Global/Local	T.P.Neutral		
childNutritionValue	Global/Local	T.P.Neutral	No	Yes
city	Global/Local	T.P.Neutral & T.P.Dependent		
claimDescription	Global/Local	T.P.Neutral	Yes	Yes
claimElementCode	Global/Local	T.P.Neutral		
claimMarkedOnPackage	Global/Local	T.P.Neutral	No	No
claimTypeCode	Global/Local	T.P.Neutral		
clampPressure	Global/Local	T.P.Neutral	No	No
classOfDangerousGoods	Global/Local	T.P.Neutral		
cleaningClothTypeCode	Global/Local	T.P.Neutral & T.P.Dependent		
clinicallyRelevantCharacteristicOfMedicalDevice	Global/Local	T.P.Neutral		
clinicalSizeDescription	Global/Local	T.P.Neutral	No	Yes
clinicalSizeTypeCode	Global/Local	T.P.Neutral		
clinicalSizeValue	Global/Local	T.P.Neutral		
clinicalSizeMeasurementPrecisionCode	Global/Local	T.P.Neutral & T.P.Dependent		
clinicalSizeValueMaximum	Global/Local	T.P.Neutral & T.P.Dependent	No	Yes
clinicalStorageHandlingDescription	Global/Local	T.P.Neutral & T.P.Dependent	Yes	Yes
clinicalStorageHandlingTypeCode	Global/Local	T.P.Neutral & T.P.Dependent		
clinicalWarningAgencyCode	Global/Local	T.P.Neutral		
clinicalWarningCode	Global/Local	T.P.Neutral		
closedCaptioningCode	Global/Local	T.P.Neutral		
closureOrFastenerLocation	Global/Local	T.P.Neutral	No	Yes
closureOrFastenerTypeCode	Global/Local	T.P.Neutral		
clothingCut	Global/Local	T.P.Neutral	No	Yes
collarType	Global/Local	T.P.Neutral	No	Yes
collectionIdentifier	Global/Local	T.P.Neutral		
collectionIdentifierTypeCode	Global/Local	T.P.Neutral		
collectionTypeCodeReference	Global/Local	T.P.Neutral		
colourDescription	Global	T.P.Neutral	No	Yes
colourCode	Global	T.P.Neutral		
colourFamilyCode	Global	T.P.Neutral		
colourTintCode	Global	T.P.Neutral		
combFilterTechnologyTypeCode	Global/Local	T.P.Neutral		

Attribute Name	Target Market Applicability	Trading Partner Neutral status	Multiple Values (Grey = N/A)	Multi Language/ Measurement / Currency
colourTemperature	Global/Local	T.P.Neutral	No	Yes
communityVisibilityDateTime	Local	T.P.Neutral		
complementAddress	Global/Local	T.P.Neutral & T.P.Dependent		
componentDescription	Global/Local	T.P.Neutral	No	Yes
componentIdentification	Global/Local	T.P.Neutral		
componentMultiplePackedQuantity	Global/Local	T.P.Neutral		
componentNumber	Global/Local	T.P.Neutral		
componentQuantity	Global/Local	T.P.Neutral	No	Yes
componentsLabeledForDisassemblyRecyclingPercent	Global	T.P.Neutral		
compositePackagingMaterialRecyclingSchemeCode	Global	T.P.Neutral		
compulsoryAdditionalLabelInformation	Local	T.P.Neutral & T.P.Dependent	No	Yes
compulsoryAdditionalLabelInformationTypeCode	Local	T.P.Neutral & T.P.Dependent	No	No
compulsoryAdditiveLabelInformation	Global/Local	T.P.Neutral	No	Yes
conditionsToAvoid	Global/Local	T.P.Neutral	Yes	Yes
connectorFinishDescription	Global/Local	T.P.Neutral	No	Yes
consumerAssemblyInstructions	Global/Local	T.P.Neutral	Yes	Yes
consumerEndAvailabilityDateTime	Global/Local	T.P.Neutral & T.P.Dependent		
consumerFirstAvailabilityDateTime	Global/Local	T.P.Neutral & T.P.Dependent		
consumerFirstDeliveryDate	Global/Local	T.P.Neutral & T.P.Dependent		
consumerFriendlyDateOnPackagingDescription	Global/Local	T.P.Neutral	No	Yes
consumerPackageDisclaimer	Global/Local	T.P.Neutral	Yes	Yes
consumerProductVariantEndEffectiveDateTime	Global/Local	T.P.Neutral & T.P.Dependent		
consumerProductVariantIdentification	Global/Local	T.P.Neutral & T.P.Dependent		
consumerProductVariantReasonCode	Global/Local	T.P.Neutral & T.P.Dependent		
consumerRecyclingInstructions	Global/Local	T.P.Neutral	No	Yes
consumerSafetyInformation	Global/Local	T.P.Neutral	Yes	Yes
consumerSalesConditionCode	Global/Local	T.P.Neutral		
consumerSalesConditionMaximumAmount	Global/Local	T.P.Neutral & T.P.Dependent	No	Yes
consumerStorageInstructions	Global/Local	T.P.Neutral	Yes	Yes
consumerUsageInstructions	Global/Local	T.P.Neutral	Yes	Yes
consumerUsageLabelCode	Global/Local	T.P.Neutral		
consumerWarningDescription	Global/Local	T.P.Neutral	Yes	Yes
consumerWarningTypeCode	Global/Local	T.P.Neutral		
contactAddress	Global/Local	T.P.Neutral		
contactDescription	Global/Local	T.P.Neutral	Yes	Yes
contactName	Global/Local	T.P.Neutral		
contactTypeCode	Global/Local	T.P.Neutral		
containedAlternativeProteinPercent	Global/Local	T.P.Neutral		
containerMaterialCode	Global/Local	T.P.Neutral		
containerProcessTypeCode	Global/Local	T.P.Neutral		
containerShapeCode	Global/Local	T.P.Neutral		
containerTypeCode	Global/Local	T.P.Neutral		

Attribute Name	Target Market Applicability	Trading Partner Neutral status	Multiple Values (Grey = N/A)	Multi Language/ Measurement / Currency
contentDate	Global/Local	T.P.Neutral		
contentDateRoleTypeCode	Global/Local	T.P.Neutral		
contentDescription	Global/Local	T.P.Neutral	No	Yes
contentsDescription	Global/Local	T.P.Neutral	No	Yes
controlledSubstanceCode	Global/Local	T.P.Neutral		
contributorDate	Global/Local	T.P.Neutral		
contributorDescription	Global/Local	T.P.Neutral	No	Yes
contributorPlaceCountry	Global/Local	T.P.Neutral		
contributorPlaceRegion	Global/Local	T.P.Neutral		
contributorPlaceTypeCode	Global/Local	T.P.Neutral		
contributorRoleCode	Global/Local	T.P.Neutral		
contributorStatement	Global/Local	T.P.Neutral	No	Yes
controlledSubstanceAmount	Global/Local	T.P.Neutral	No	No
controlledSubstanceName	Global/Local	T.P.Neutral		
controlledSubstanceScheduleCodeReference	Global/Local	T.P.Neutral		
controlOfHazardousSubstancesRegulationsAgency	Global/Local	T.P.Neutral		
controlOfHazardousSubstancesRegulationsRegulationName	Global/Local	T.P.Neutral		
convenienceLevelPercent	Global/Local	T.P.Neutral		
copyrightFee	Global/Local	T.P.Neutral	No	No
copyrightOwnerIdentifier	Global/Local	T.P.Neutral		
copyrightOwnerIdentifierTypeCodeReference	Global/Local	T.P.Neutral		
copyrightRate	Global/Local	T.P.Neutral		
copyrightYear	Global/Local	T.P.Neutral		
corporateName	Global/Local	T.P.Neutral		
corporateNameInverted	Global/Local	T.P.Neutral		
countryOfOriginStatement	Global/Local	T.P.Neutral	Yes	Yes
couponFamilyCode	Local	T.P.Neutral		
countryCode	Global/Local	T.P.Neutral & T.P.Dependent		
creditableAlternativeProteinPerPortion	Global/Local	T.P.Neutral	No	Yes
creditableAmount	Global/Local	T.P.Neutral	No	Yes
creditableGrainAmountPerPortion	Global/Local	T.P.Neutral	No	Yes
creditableGrainGroupCode	Global/Local	T.P.Neutral		
creditableGrainStandard	Global/Local	T.P.Neutral		
creditableIngredientAmountPerRawPortion	Global/Local	T.P.Neutral	No	Yes
creditableIngredientDescription	Global/Local	T.P.Neutral	No	Yes
creditableIngredientTypeCode	Global/Local	T.P.Neutral		
cumulativeEnergyDemand	Global/Local	T.P.Neutral	No	No
cumulativeEnergyDemandDescription	Global/Local	T.P.Neutral	No	Yes
cumulativeEnergyDemandProtocolCode	Global/Local	T.P.Neutral		
cumulativeEnergyDemandProtocolDescription	Global/Local	T.P.Neutral	No	Yes
cumulativeEnergyDemandReferenceSubstanceCode	Global/Local	T.P.Neutral		
cumulativeEnergyDemandReferenceSubstanceDescription	Global/Local	T.P.Neutral	No	Yes
cumulativeEnergyDemandTypeCode	Global/Local	T.P.Neutral		
cumulativeHumidityInterruptionAcceptableTimeSpan	Global/Local	T.P.Neutral		
cumulativeHumidityInterruptionAcceptableTimeSpanInstructions	Global/Local	T.P.Neutral	No	Yes

Attribute Name	Target Market Applicability	Trading Partner Neutral status	Multiple Values (Grey = N/A)	Multi Language/ Measurement / Currency
cumulativeTemperatureInterruptionAcceptableTimeSpan	Global/Local	T.P.Neutral		
cumulativeTemperatureInterruptionAcceptableTimeSpanInstructions	Global/Local	T.P.Neutral	No	Yes
curingMethodDescription	Global	T.P.Neutral & T.P.Dependent	No	Yes
cutForSaleThicknessCode	Global/Local	T.P.Neutral		
dailyValueIntakePercent	Global/Local	T.P.Neutral		
dailyValueIntakePercentMeasurementPrecisionCode	Global/Local	T.P.Neutral		
dailyValueIntakeReference	Global/Local	T.P.Neutral	No	Yes
dangerousGoodsClassificationCode	Global/Local	T.P.Neutral		
dangerousGoodsHazardousCode	Global/Local	T.P.Neutral		
dangerousGoodsLimitedQuantitiesCode	Global/Local	T.P.Neutral		
dangerousGoodsLimitedQuantityIndex	Global/Local	T.P.Neutral		
dangerousGoodsPackingGroup	Global/Local	T.P.Neutral		
dangerousGoodsPackagingTypeCode	Global/Local	T.P.Neutral		
dangerousGoodsRegulationAgency	Global/Local	T.P.Neutral		
dangerousGoodsRegulationCode	Global/Local	T.P.Neutral		
dangerousGoodsShippingName	Global/Local	T.P.Neutral	Yes	Yes
dangerousGoodsSpecialProvisions	Global/Local	T.P.Neutral		
dangerousGoodsSubsidiaryClass	Global/Local	T.P.Neutral		
dangerousGoodsTechnicalName	Global/Local	T.P.Neutral	No	Yes
dangerousGoodsTransportCategoryCode	Global/Local	T.P.Neutral		
dangerousHazardousLabelNumber	Global/Local	T.P.Neutral		
dangerousHazardousLabelSequenceNumber	Global/Local	T.P.Neutral		
dangerousSubstanceGasDensity	Global/Local	T.P.Neutral	No	No
dangerousSubstanceHazardSymbolCodeReference	Global/Local	T.P.Neutral		
dangerousSubstanceHeatOfCombustion	Global/Local	T.P.Neutral	No	No
dangerousSubstanceName	Global/Local	T.P.Neutral		
dangerousSubstancePhaseOfMatterCode	Global/Local	T.P.Neutral		
dangerousSubstancesWaterSolubilityCode	Global/Local	T.P.Neutral		
dangerousSubstanceWasteCode	Global/Local	T.P.Neutral		
dataCarrierFamilyTypeCode	Global	T.P.Neutral		
dataCarrierPresenceCode	Global/Local	T.P.Neutral		
dataCarrierTypeCode	Global	T.P.Neutral		
dateOfCatchProcessTypeCode	Global/Local	T.P.Neutral		
declaredPower	Global/Local	T.P.Neutral	No	Yes
degreeOfOriginalWort	Global/Local	T.P.Neutral		
deliveryFrequencyCode	Global/Local	T.P.Neutral & T.P. Dependent		
depositValueEffectiveDateTime	Global/Local	T.P.Neutral		
depositValueEndDateTime	Global/Local	T.P.Neutral		
depth (AdditionalTradeItemDimension)	Global/Local	T.P.Neutral & T.P.Dependent	No	Yes
depth (TradeItemMeasurements)	Global/Local	T.P.Neutral	No	No
depth(NonGTINLogisticsUnitInformation)	Global/Local	T.P.Neutral & T.P.Dependent	No	No
descriptionOnANutrient	Global/Local	T.P.Neutral	Yes	Yes
descriptionOnNutrientQualifier	Global/Local	T.P.Neutral		
descriptionShort	Global	T.P.Neutral	No	Yes
descriptionSource	Global/Local	T.P.Neutral		

Attribute Name	Target Market Applicability	Trading Partner Neutral status	Multiple Values (Grey = N/A)	Multi Language/ Measurement / Currency
descriptiveSize	Global	T.P.Neutral	No	No
descriptiveSizeDimension	Global	T.P.Neutral	No	Yes
designer	Global/Local	T.P.Neutral	Yes	Yes
detachableSpeakerTypeCode	Global/Local	T.P.Neutral		
deviceSubStatusEndDateTime	Global/Local	T.P.Neutral & T.P.Dependent		
deviceSubStatusStartDateTime	Global/Local	T.P.Neutral & T.P.Dependent		
dexterityUsageCode	Global/Local	T.P.Neutral		
diameter	Global/Local	T.P.Neutral	No	No
dietCertification	Global/Local	T.P.Neutral		
dietTypeCode	Global/Local	T.P.Neutral		
dietTypeDescription	Global/Local	T.P.Neutral	No	Yes
dietTypeSubcode	Global/Local	T.P.Neutral		
digitalisationLevelCode	Global/Local	T.P.Neutral		
dimensionTypeCode	Global/Local	T.P.Neutral		
directPartMarkingIdentifier	Global/Local	T.P.Neutral		
discNumber	Global/Local	T.P.Neutral		
discountApplicablePeriod	Global/Local	T.P.Neutral & T.P.Dependent		
discountBaseTypeCode	Global/Local	T.P.Neutral & T.P.Dependent		
discontinuedDateTime	Global/Local	T.P.Neutral		
discountAmount	Global/Local	T.P.Neutral & T.P.Dependent	No	No
discountDescription	Global/Local	T.P.Neutral & T.P.Dependent	No	Yes
discountPercent	Global/Local	T.P.Neutral & T.P.Dependent		
discountRestrictionTargetMarketCountry	Global/Local	T.P.Neutral		
discountType	Global/Local	T.P.Neutral & T.P.Dependent		
dispenserTypeCode	Global/Local	T.P.Neutral & T.P.Dependent		
displayPanelBacklightType	Global/Local	T.P.Neutral		
displayResolutionCode	Global/Local	T.P.Neutral		
displayScreenBezelSize	Global/Local	T.P.Neutral	No	Yes
displayScreenSize	Global/Local	T.P.Neutral	No	Yes
displayScreenTypeCode	Global/Local	T.P.Neutral		
displayTypeCode	Global/Local	T.P.Neutral		
distributionMediaCount	Global/Local	T.P.Neutral		
distributionMediaTypeCode	Global/Local	T.P.Neutral		
distributionMethodCode	Global/Local	T.P.Neutral & T.P.Dependent		
doesItemComeWithHanger	Global/Local	T.P.Neutral		
doesItemContainAControlledSubstance	Global/Local	T.P.Neutral		
doesManufacturerHaveTakeBackProgram	Global/Local	T.P.Neutral		
doesPackagingHaveWheels	Global/Local	T.P.Neutral		
doesPackagingRecoveryRateTypeCodeMeetTheStandard	Global/Local	T.P.Neutral		
doesSaleOfTradeItemRequireGovernmentalReporting	Global/Local	T.P.Neutral		
doesTradeItemContainAnimalTissue	Global/Local	T.P.Neutral		
doesTradeItemCompositionIncludeLatex	Global/Local	T.P.Neutral		
doesTradeItemContainHumanBloodDerivative	Global/Local	T.P.Neutral		

Attribute Name	Target Market Applicability	Trading Partner Neutral status	Multiple Values (Grey = N/A)	Multi Language/ Measurement / Currency
doesTradeItemContainHumanTissue	Global/Local	T.P.Neutral		
doesTradeItemContainElectricalComponents	Global/Local	T.P.Neutral & T.P.Dependent		
doesTradeItemContainLatex	Global/Local	T.P.Neutral		
doesTradeItemContainMicrobialSubstance	Global/Local	T.P.Neutral		
doesTradeItemContainNoncreditableGrains	Global/Local	T.P.Neutral		
doesTradeItemContainPesticide	Global	T.P.Neutral		
doesTradeItemContainPropellant	Global	T.P.Neutral		
doesTradeItemHaveAutoReaderTracker	Global/Local	T.P.Neutral		
doesTradeItemHaveRefuseObligations	Global/Local	T.P.Neutral		
doesTradeItemMeetWholeGrainRichCriteria	Global/Local	T.P.Neutral		
doPackagingMaterialsContainLatex	Global/Local	T.P.Neutral		
dosageFormType	Global/Local	T.P.Neutral		
dosageRecommendation	Global/Local	T.P.Neutral	Yes	Yes
dosageRestrictionLimits	Global/Local	T.P.Neutral	Yes	Yes
driedEquivalent	Global/Local	T.P.Neutral & T.P.Dependent	No	Yes
drainedWeight	Global/Local	T.P.Neutral	No	No
drinkingMaturityEndYear	Global/Local	T.P.Neutral	No	No
drinkingMaturityStartYear	Global/Local	T.P.Neutral	No	No
dropBelowMinimumHumidityAcceptableTimeSpan	Global/Local	T.P.Neutral		
dropBelowMinimumTemperatureAcceptableTimeSpan	Global/Local	T.P.Neutral		
drugInteractions	Global/Local	T.P.Neutral	Yes	Yes
drugPreparations	Global/Local	T.P.Neutral	Yes	Yes
drugSideEffectsAndWarnings	Global/Local	T.P.Neutral	Yes	Yes
dryingMethodTypeCode	Global/Local	T.P.Neutral		
dubbedLanguageCode	Global/Local	T.P.Neutral		
dubbedSubtitledCode	Global/Local	T.P.Neutral		
dutyFeeTaxAgencyCode	Global/Local	T.P.Neutral		
dutyFeeTaxAgencyName	Global/Local	T.P.Neutral		
dutyFeeTaxAmount	Global/Local	T.P.Neutral	No	No
dutyFeeTaxBasis	Global/Local	T.P.Neutral	Yes	Yes
dutyFeeTaxBasisPrice	Global/Local	T.P.Neutral	No	Yes
dutyFeeTaxCategoryCode	Global/Local	T.P.Neutral		
dutyFeeTaxClassificationCode	Global/Local	T.P.Neutral		
dutyFeeTaxCountryCode	Global/Local	T.P.Neutral		
dutyFeeTaxCountrySubdivisionCode	Global/Local	T.P.Neutral		
dutyFeeTaxCountrySubdivisionShipFromCode	Global/Local	T.P.Neutral		
dutyFeeTaxCountrySubdivisionShipToCode	Global/Local	T.P.Neutral		
dutyFeeTaxEffectiveEndDateTime	Global/Local	T.P.Neutral		
dutyFeeTaxEffectiveStartDateTime	Global/Local	T.P.Neutral		
dutyFeeTaxExemptPartyRoleCode	Global/Local	T.P.Neutral		
dutyFeeTaxLegalProvision	Global/Local	T.P.Neutral	No	Yes
dutyFeeTaxRate	Global/Local	T.P.Neutral		
dutyFeeTaxReductionCriteriaDescription	Global/Local	T.P.Neutral	No	Yes
dutyFeeTaxTypeCode	Global/Local	T.P.Neutral		
dutyFeeTaxTypeDescription	Global/Local	T.P.Neutral	No	Yes
dvdRegionCode	Global/Local	T.P.Neutral		
dynamicContrastRatio	Global/Local	T.P.Neutral		

Attribute Name	Target Market Applicability	Trading Partner Neutral status	Multiple Values (Grey = N/A)	Multi Language/ Measurement / Currency
ecologicalInformationDescription	Global/Local	T.P.Neutral	No	Yes
econtentEnvironmentTypeCode	Global/Local	T.P.Neutral & T.P.Dependent		
econtentTradeItemStatement	Global/Local	T.P.Neutral & T.P.Dependent	No	Yes
editionDescription	Global/Local	T.P.Neutral	No	Yes
editionNumber	Global/Local	T.P.Neutral		
editionStatement	Global/Local	T.P.Neutral	No	Yes
editionTypeCode	Global/Local	T.P.Neutral		
editionVersionNumber	Global/Local	T.P.Neutral		
educationalFocusDescription	Global/Local	T.P.Neutral	No	Yes
effectiveDateTime	Global/Local	T.P.Neutral		
electronicProgrammingGuideDaysAvailable	Global/Local	T.P.Neutral		
endAvailabilityDateTime	Global/Local	T.P.Neutral & T.P.Dependent		
endDateTimeOfExclusivity	Global/Local	T.P.Neutral & T.P.Dependent		
endMaximumBuyingQuantityDateTime	Global/Local	T.P.Neutral & T.P.Dependent		
endMinimumBuyingQuantityDateTime	Global/Local	T.P.Neutral & T.P.Dependent		
enumerationValue	Global/Local	T.P.Neutral		
enumerationValueDefinition	Global/Local	T.P.Neutral	No	Yes
enumerationValueDescription	Global/Local	T.P.Neutral	No	Yes
epubTechnicalProtectionTypeCode	Global/Local	T.P.Neutral		
epubUsageLimit	Global/Local	T.P.Neutral		
epubUsageStatus	Global/Local	T.P.Neutral		
epubUsageType	Global/Local	T.P.Neutral		
equalizerControlFeatures	Global/Local	T.P.Neutral	No	Yes
equivalentLightBulbPower	Global/Local	T.P.Neutral	No	Yes
eRGNumber	Global/Local	T.P.Neutral		
eUMedicalDeviceStatus	Global/Local	T.P.Neutral & T.P.Dependent		
eUMedicalDeviceSubStatusCode	Global/Local	T.P.Neutral & T.P.Dependent		
exactPH	Global	T.P.Neutral		
exhibitGroup	Global/Local	T.P.Neutral		
expectedResultsTime	Global	T.P.Neutral	No	Yes
experienceLevel	Global/Local	T.P.Neutral	No	Yes
exposureMode	Global/Local	T.P.Neutral		
expressedAsPartOf	Global/Local	T.P.Neutral		
extentTypeCode	Global/Local	T.P.Neutral		
extentUnitCode	Global/Local	T.P.Neutral		
extentValue	Global/Local	T.P.Neutral		
extentValueRoman	Global/Local	T.P.Neutral		
externalAgencyName	Global/Local	T.P.Neutral		
externalAgriculturalQualityStandardAgencyCode	Global/Local	T.P.Neutral & T.P.Dependent		
externalAgriculturalQualityStandardCategoryCode	Global/Local	T.P.Neutral & T.P.Dependent		
externalAgriculturalQualityStandardCode	Global/Local	T.P.Neutral & T.P.Dependent		
externalCodeListName	Global/Local	T.P.Neutral		
externalCodeListVersion	Global/Local	T.P.Neutral		
externalMemoryTypeCode	Global/Local	T.P.Neutral		

Attribute Name	Target Market Applicability	Trading Partner Neutral status	Multiple Values (Grey = N/A)	Multi Language/ Measurement / Currency
extinguishingMediaDescription	Global/Local	T.P.Neutral	No	Yes
extractionProcessCode	Global/Local	T.P.Neutral & T.P.Dependent		
extremelyHazardousSubstanceQuantity	Global/Local	T.P.Neutral	No	No
facilitiesInStressedWaterAreaCalculationMethod	Global/Local	T.P.Neutral	No	Yes
facilitiesInStressedWaterAreaPercent	Global/Local	T.P.Neutral		
fatInMilkContent	Global/Local	T.P.Neutral		
fatPercentageInDryMatter	Global/Local	T.P.Neutral		
fatPercentageInDryMatterMeasurementPrecisionCode	Global/Local	T.P.Neutral		
feedingAmount	Global/Local	T.P.Neutral	No	Yes
feedingAmountBasisDescription	Global/Local	T.P.Neutral	No	Yes
feedingInstructions	Global/Local	T.P.Neutral	No	Yes
feedAdditiveStatement	Global/Local	T.P.Neutral	No	Yes
feedAnalyticalConstituentsStatement	Global/Local	T.P.Neutral	No	Yes
feedCompositionStatement	Global/Local	T.P.Neutral	No	Yes
feedLifestage	Global/Local	T.P.Neutral	No	Yes
feedLifestageCode	Global/Local	T.P.Neutral		
feedType	Global/Local	T.P.Neutral		
fieldOfView	Global/Local	T.P.Neutral	Yes	Yes
fileAspectRatio	Global	T.P.Neutral		
fileAuthorName	Global	T.P.Neutral		
fileBackgroundColourDescription	Global	T.P.Neutral	Yes	Yes
fileCameraPerspective	Global	T.P.Neutral	Yes	Yes
fileCameraPerspectiveCode	Global/Local	T.P.Neutral		
fileCampaignDescription	Global	T.P.Neutral	Yes	Yes
fileColourCalibration	Global	T.P.Neutral	Yes	Yes
fileColourSchemeCode	Global	T.P.Neutral		
fileCompressionType	Global	T.P.Neutral	Yes	Yes
fileContrast	Global	T.P.Neutral		
fileCopyrightDescription	Global	T.P.Neutral	Yes	Yes
fileCreationProgram	Global	T.P.Neutral		
fileDepictedSceneDescription	Global	T.P.Neutral	Yes	Yes
fileDepictedSeason	Global	T.P.Neutral	Yes	Yes
fileDisclaimerInformation	Global/Local	T.P.Neutral	Yes	Yes
fileEffectiveEndDateTime	Global/Local	T.P.Neutral		
fileEffectiveStartDateTime	Global/Local	T.P.Neutral		
fileFeeDescription	Global/Local	T.P.Neutral	Yes	Yes
fileFormatDescription	Global/Local	T.P.Neutral	No	Yes
fileFormatName	Global/Local	T.P.Neutral		
fileItemPositionCode	Global	T.P.Neutral		
fileLanguageCode	Global	T.P.Neutral		
fileLayerQuantity	Global	T.P.Neutral		
fileLifeStyleDescription	Global	T.P.Neutral	Yes	Yes
429ilename	Global/Local	T.P.Neutral		
fileOptimalViewerName	Global	T.P.Neutral		
fileOriginCountryCode	Global/Local	T.P.Neutral		
filePixelHeight	Global/Local	T.P.Neutral		
filePixelWidth	Global/Local	T.P.Neutral		
filePlaybackRate	Global	T.P.Neutral		

Attribute Name	Target Market Applicability	Trading Partner Neutral status	Multiple Values (Grey = N/A)	Multi Language/ Measurement / Currency
filePrintHeight	Global	T.P.Neutral	No	Yes
filePrintWidth	Global	T.P.Neutral	No	Yes
fileRecommendedUsageDescription	Global	T.P.Neutral	Yes	Yes
fileResolutionDescription	Global	T.P.Neutral	No	Yes
fileRightsDescription	Global/Local	T.P.Neutral	Yes	Yes
fileRunTime	Global	T.P.Neutral		
fileSequenceNumber	Global/Local	T.P.Neutral		
fileSize	Global	T.P.Neutral	Yes	Yes
fileStoryDescription	Global	T.P.Neutral	Yes	Yes
fileTalentDescription	Global	T.P.Neutral	Yes	Yes
fileUsageRestriction	Global	T.P.Neutral	Yes	Yes
fileVersion	Global	T.P.Neutral		
fireFighterProtectiveEquipmentDescription	Global/Local	T.P.Neutral	No	Yes
firmnessOfCheeseCode	Global/Local	T.P.Neutral		
firstAidProceduresDescription	Global/Local	T.P.Neutral	No	Yes
firstDeliveryDateTime	Global/Local	T.P.Neutral & T.P.Dependent		
firstOrderDateTime	Global/Local	T.P.Neutral & T.P.Dependent		
firstReturnableDateTime	Global/Local	T.P.Neutral & T.P.Dependent		
firstShipDateTime	Global/Local	T.P.Neutral & T.P.Dependent		
fiscalYear	Global/Local	T.P.Neutral	No	No
fishMeatPoultryTypeCodeReference	Global/Local	T.P.Neutral		
fishSeafoodPresentationCode	Global	T.P.Neutral	Yes	No
fixedSpeakerLocationCode	Global/Local	T.P.Neutral		
flammableAerosolContainmentCode	Global/Local	T.P.Neutral		
flammableGasWeight	Global/Local	T.P.Neutral	No	No
flammablePropertiesDescription	Global/Local	T.P.Neutral	No	Yes
flammableSubstanceMaximumPercent	Global/Local	T.P.Neutral		
flammableSubstanceMinimumPercent	Global/Local	T.P.Neutral		
flashPointDescriptor	Global/Local	T.P.Neutral	No	Yes
flashPointTemperature	Global/Local	T.P.Neutral	No	Yes
flashPointTemperatureLowerValue	Global/Local	T.P.Neutral	No	Yes
flashPointTemperatureMeasurementPrecision	Global/Local	T.P.Neutral		
flashPointTemperatureUpperValue	Global/Local	T.P.Neutral	No	Yes
flashPointTestMethodCode	Global/Local	T.P.Neutral		
flowerTrimmingMethodCode	Global/Local	T.P.Neutral & T.P.Dependent		
floweringTriggerCode	Global/Local	T.P.Neutral & T.P.Dependent		
foodBeverageCompositionCode	Global/Local	T.P.Neutral		
foodBeverageCompositionDatabaseCode	Global/Local	T.P.Neutral		
foodBeverageCompositionDescription	Global/Local	T.P.Neutral		
foodMaterialDescription	Global/Local	T.P.Neutral	No	Yes
foodMaterialCode	Global/Local	T.P.Neutral	No	No
foodValueBasis	Global/Local	T.P.Neutral	No	Yes
foodValueBasisTypeCode	Global/Local	T.P.Neutral		
foodValuePerTradeItem	Global/Local	T.P.Neutral	No	Yes
footwearOutsoleTypeCode	Global/Local	T.P.Neutral	No	No
footwearStyleCode	Global/Local	T.P.Neutral	No	No



Attribute Name	Target Market Applicability	Trading Partner Neutral status	Multiple Values (Grey = N/A)	Multi Language/ Measurement / Currency
freeQuantityOfNextLowerLevelTradeItem	Global/Local	T.P.Neutral	No	Yes
freeQuantityOfProduct	Global/Local	T.P.Neutral	No	Yes
freezingMeltingPoint	Global/Local	T.P.Neutral	No	Yes
freshWaterEcotoxicityMeasurement	Global/Local	T.P.Neutral	No	No
freshWaterEcotoxicityModelCode	Global/Local	T.P.Neutral		
freshWaterEcotoxicityModelDescription	Global/Local	T.P.Neutral	No	Yes
freshWaterEcotoxicityReferenceSubstanceCode	Global/Local	T.P.Neutral		
freshWaterEcotoxicityReferenceSubstanceDescription	Global/Local	T.P.Neutral	No	Yes
fromLanguage	Global/Local	T.P.Neutral		
frontFaceTypeCode	Global/Local	T.P.Neutral		
functionalBasisUnitCode	Global/Local	T.P.Neutral		
functionalBasisUnitDescription	Global/Local	T.P.Neutral	No	Yes
functionalName	Global/Local	T.P.Neutral	No	Yes
gameFormatCode	Global/Local	T.P.Neutral		
geneticallyModifiedDeclarationCode	Global/Local	T.P.Neutral		
genreTypeCodeReference	Global/Local	T.P.Neutral		
genus	Global	T.P.Neutral		
gHSSignalWordsCode	Global/Local	T.P.Neutral		
gHSSymbolDescriptionCode	Global/Local	T.P.Neutral		
globalModelDescription	Global/Local	T.P.Neutral & T.P.Dependent	No	Yes
globalModelNumber	Global/Local	T.P.Neutral	No	No
globalModelRegulatoryAct	Global/Local	T.P.Neutral		
globalModelRegulatoryActCountryCode	Global/Local	T.P.Neutral		
globalWarmingPotentialEquivalent	Global/Local	T.P.Neutral	No	No
globalWarmingPotentialEquivalentBasisYearsCode	Global/Local	T.P.Neutral		
globalWarmingPotentialEquivalentBasisYearsDescription	Global/Local	T.P.Neutral	No	Yes
globalWarmingPotentialEquivalentProtocolCode	Global/Local	T.P.Neutral		
globalWarmingPotentialEquivalentProtocolDescription	Global/Local	T.P.Neutral	No	Yes
globalWarmingPotentialEquivalentSubstanceCode	Global/Local	T.P.Neutral		
globalWarmingPotentialEquivalentSubstanceDescription	Global/Local	T.P.Neutral	No	Yes
goodsPickUpLeadTime	Global/Local	T.P.Neutral	No	No
gpcAttributeTypeCode	Global	T.P.Neutral		
gpcAttributeTypeDefinition	Global	T.P.Neutral		
gpcAttributeTypeName	Global	T.P.Neutral		
gpcAttributeValueCode	Global	T.P.Neutral		
gpcAttributeValueName	Global	T.P.Neutral		
gpcCategoryCode	Global	T.P.Neutral		
gpcCategoryDefinition	Global	T.P.Neutral		
gpcCategoryName	Global	T.P.Neutral		
gradeCodeReference	Global/Local	T.P.Neutral		
grai	Global	T.P.Neutral		
grapeVarietyCode	Global/Local	T.P.Neutral		
grossWeight (AdditionalTradeItemDimensions)	Global/Local	T.P.Neutral & T.P.Dependent	No	Yes
grossWeight (TradeItemMeasurements)	Global/Local	T.P.Neutral	No	No

Attribute Name	Target Market Applicability	Trading Partner Neutral status	Multiple Values (Grey = N/A)	Multi Language/ Measurement / Currency
grossWeight (NonGTINLogisticsUnitInformation)	Global/Local	T.P.Neutral & T.P.Dependent	No	No
growthCycle	Global/Local	T.P.Neutral & T.P.Dependent	No	Yes
growingLightConditionTypeCode	Global/Local	T.P.Neutral		
growingMethodCode	Global/Local	T.P.Neutral		
gs1TradeItemIdentificationKeyCode	Global/Local	T.P.Neutral		
gs1TradeItemIdentificationKeyValue	Global/Local	T.P.Neutral		
gtin	Global	T.P.Neutral		
hairStyleFixationCode	Global/Local	T.P.Neutral		
handlingInstructionsCodeReference	Global	T.P.Neutral		
handlingInstructionsDescription	Global	T.P.Neutral	No	Yes
hasBatchNumber	Local	T.P.Neutral		
hasCancerousProperties	Global/Local	T.P.Neutral		
hasDeviceMeasuringFunction	Global/Local	T.P.Neutral		
hasDisplayReadyPackaging	Global/Local	T.P.Neutral		
hasParentalAdvisorySticker	Global/Local	T.P.Neutral		
haveYouMinimizedHazardousSubstance	Global/Local	T.P.Neutral		
hazardousClassSubsidiaryRiskCode	Global/Local	T.P.Neutral		
hazardousMaterialAdditionalInformation	Global/Local	T.P.Neutral	No	Yes
hazardousMaterialsHandlingProcedures	Global/Local	T.P.Neutral	Yes	Yes
hazardousSubstancesMinimizationCode	Global/Local	T.P.Neutral		
hazardousWasteAgency	Global/Local	T.P.Neutral		
hazardousWasteCode	Global/Local	T.P.Neutral		
hazardousWasteDescription	Global/Local	T.P.Neutral	No	Yes
hazardStatementsCode	Global/Local	T.P.Neutral		
hazardStatementsDescription	Global/Local	T.P.Neutral	No	Yes
hDMITestingAgencyCode	Global/Local	T.P.Neutral		
healthcareItemMaximumUsageAge	Global/Local	T.P.Neutral & T.P.Dependent		
healthcareItemMinimumUsageAge	Global/Local	T.P.Neutral & T.P.Dependent		
healthcareItemUsageAgeDescription	Global/Local	T.P.Neutral & T.P.Dependent	No	Yes
healthcareGroupedProductCode	Global/Local	T.P.Neutral		
height (AdditionalTradeItemDimensions)	Global/Local	T.P.Neutral & T.P.Dependent	No	Yes
height (TradeItemMeasurements)	Global/Local	T.P.Neutral	No	No
height(NonGTINLogisticsUnitInformation)	Global/Local	T.P.Neutral & T.P.Dependent	No	No
horizontalViewingAngle	Global/Local	T.P.Neutral		
householdCleaningProductTypeCode	Global/Local	T.P.Neutral & T.P.Dependent		
humidityQualifierCode	Global/Local	T.P.Neutral		
illegalToAdvertiseTargetMarket	Global/Local	T.P.Neutral		
illustrationNote	Global/Local	T.P.Neutral	No	Yes
illustrationTypeCode	Global/Local	T.P.Neutral		
imageFacingCode	Global/Local	T.P.Neutral & T.P.Dependent		
imageOrientationTypeCode	Global/Local	T.P.Neutral & T.P.Dependent		
imageStateCode	Global/Local	T.P.Neutral & T.P.Dependent		
imitationOrSubstituteFor	Global/Local	T.P.Neutral	No	Yes



Attribute Name	Target Market Applicability	Trading Partner Neutral status	Multiple Values (Grey = N/A)	Multi Language/ Measurement / Currency
importClassificationCountrySubdivisionRegionOfOrigin	Global/Local	T.P.Neutral		
importClassificationTypeCode	Global/Local	T.P.Neutral		
importClassificationValue	Global/Local	T.P.Neutral		
inBoxCubeDimension	Global/Local	T.P.Neutral	No	No
includedOperatingSystem	Global/Local	T.P.Neutral		
incotermCode	Global/Local	T.P.Neutral		
incotermCodeLocation	Global/Local	T.P.Neutral		
incotermCountryCode	Global/Local	T.P.Neutral		
individualUnitMaximumSize	Global/Local	T.P.Neutral	No	No
individualUnitMinimumSize	Global/Local	T.P.Neutral	No	No
industrySpecificPackagingTypeCodeReference	Global/Local	T.P.Neutral		
informationProviderOfTradeItem	Global	T.P.Neutral		
ingredientCode	Global/Local	T.P.Neutral	No	No
ingredientContentPercentage	Global/Local	T.P.Neutral		
ingredientContentPercentageMeasurementPrecisionCode	Global/Local	T.P.Neutral		
ingredientCountryOfOriginCode	Global/Local	T.P.Neutral		
ingredientDefinition	Global/Local	T.P.Neutral	No	Yes
ingredientGeneticallyModifiedDeclarationCode	Global/Local	T.P.Neutral		
ingredientGrowingMethodCode	Global/Local	T.P.Neutral		
ingredientIrradiatedCode	Global/Local	T.P.Neutral		
ingredientName	Global/Local	T.P.Neutral	No	Yes
ingredientOfConcernCode	Global/Local	T.P.Neutral		
ingredientPurpose	Global/Local	T.P.Neutral		
ingredientSequence	Global/Local	T.P.Neutral		
ingredientSourceAnimalCode	Global/Local	T.P.Neutral		
ingredientStatement	Global/Local	T.P.Neutral	Yes	Yes
ingredientStrength	Global/Local	T.P.Neutral	No	No
ingredientStrengthBasis	Global/Local	T.P.Neutral	No	No
initialManufacturerSterilisationCode	Global/Local	T.P.Neutral		
initialSterilisationPriorToUseCode	Global/Local	T.P.Neutral		
intendedPublicationCountryCode	Global/Local	T.P.Neutral		
intendedPublicationMediaTypeDescription	Global/Local	T.P.Neutral	Yes	Yes
internalMemoryTypeCode	Global/Local	T.P.Neutral		
inventoryDrawdownPerTradeItem	Global/Local	T.P.Neutral	No	Yes
invoiceName	Global	T.P.Neutral	No	Yes
irradiatedCode	Global/Local	T.P.Neutral		
isActiveDevice	Global/Local	T.P.Neutral		
isAcutelyHazardousWaste	Global/Local	T.P.Neutral		
isAllergenRelevantDataProvided	Global/Local	T.P.Neutral		
isAssemblyRequired	Global	T.P.Neutral		
isBarcodeDerivable	Global	T.P.Neutral		
isBarcodeOnPackageVariableMeasureBarcode	Global	T.P.Neutral		
isBasePriceDeclarationRelevant	Global/Local	T.P.Neutral		
isBioengineeredDeclarationClaimRelevantDataProvided	Global/Local	T.P.Neutral & T.P.Dependent	No	No
isCannabisPlantAHybrid	Global	T.P.Neutral & T.P.Dependent		
isCaskStrength	Global/Local	T.P.Neutral		

Attribute Name	Target Market Applicability	Trading Partner Neutral status	Multiple Values (Grey = N/A)	Multi Language/ Measurement / Currency
isBatteryRechargeable	Global/Local	T.P.Neutral		
isCertificateRequired	Global/Local	T.P.Neutral & T.P.Dependent		
isChemicalRegulationCompliant	Global/Local	T.P.Neutral		
isClaimRegulated	Global	T.P.Neutral		
isCommunicationChannelMarkedOnPackage	Global/Local	T.P.Neutral		
isContactInformationMarkedOnPackage	Global/Local	T.P.Neutral		
isDangerousSubstance	Global/Local	T.P.Neutral		
isDangerousSubstanceAMixture	Global/Local	T.P.Neutral		
isDesignationIntendedForSingleUse	Global	T.P.Neutral & T.P.Dependent		
isDeviceCompanionDiagnostic	Global/Local	T.P.Neutral		
isDeviceDesignedForProfessionalTesting	Global/Local	T.P.Neutral		
isDeviceExemptFromImplantObligations	Global/Local	T.P.Neutral		
isDeviceInstrument	Global/Local	T.P.Neutral		
isDeviceIntendedToAdministerOrRemoveMedicinalProduct	Global/Local	T.P.Neutral		
isDeviceMedicinalProduct	Global/Local	T.P.Neutral		
isDeviceNearPatientTesting	Global/Local	T.P.Neutral		
isDevicePatientSelfTesting	Global/Local	T.P.Neutral		
isDeviceReagent	Global/Local	T.P.Neutral		
isDietTypeMarkedOnPackage	Global/Local	T.P.Neutral		
isDigitalDownloadAvailable	Global/Local	T.P.Neutral		
isDiscountingIllegal	Global/Local	T.P.Neutral		
isDiscountingIllegalInTargetMarket	Global/Local	T.P.Neutral		
isDistributionMethodPrimary	Global/Local	T.P.Neutral		
isEligibleForRevenueShare	Global/Local	T.P.Neutral		
isExemptFromPremarketAuthorisation	Global/Local	T.P.Neutral		
isExtendedWarrantyFreeOfFees	Global/Local	T.P.Neutral & T.P.Dependent		
isFileBackgroundTransparent	Global	T.P.Neutral		
isFileForInternalUseOnly	Global	T.P.Neutral		
isGradedBeforePreparationTypeApplied	Global/Local	T.P.Neutral		
isHomogenised	Global/Local	T.P.Neutral		
isImageRendered	Global/Local	T.P.Neutral & T.P.Dependent		
isImitationOrSubstitute	Global/Local	T.P.Neutral		
isIngredientActive	Global/Local	T.P.Neutral		
isIngredientEmphasised	Global/Local	T.P.Neutral		
isIngredientGeneric	Global/Local	T.P.Neutral		
isIngredientRelevantDataProvided	Global/Local	T.P.Neutral		
isLightBulbSuitableForAccentLighting	Global/Local	T.P.Neutral		
isNetContentDeclarationIndicated	Global/Local	T.P.Neutral		
isNewDevice	Global/Local	T.P.Neutral & T.P.Dependent		
isNonfoodIngredientEmphasized	Global/Local	T.P.Neutral		
isNonGTINLogisticsUnitPackedIrregularly	Global/Local	T.P.Neutral		
isNonSoldTradeItemReturnable	Global/Local	T.P.Neutral		
isNutrientOnFrontOfPackage	Global/Local	T.P.Neutral	No	N0
isNutrientRelevantDataProvided	Global/Local	T.P.Neutral		
isOneTimeBuy	Global/Local	T.P.Neutral		
isOrphanDrug	Global/Local	T.P.Neutral		

Attribute Name	Target Market Applicability	Trading Partner Neutral status	Multiple Values (Grey = N/A)	Multi Language/ Measurement / Currency
isPackagingClaimMarkedOnPackage	Global/Local	T.P.Neutral & T.P.Dependent		
isPackagingClaimRegulated	Global/Local	T.P.Neutral & T.P.Dependent		
isPackagingElementIntendedForFoodContact	Global	T.P.Neutral		
isPackagingExemptFromRefuseObligation	Global/Local	T.P.Neutral		
isPackagingLabelledWithDrugFacts	Global/Local	T.P.Neutral		
isPackagingMarkedReturnable	Global	T.P.Neutral		
isPackagingMarkedWithIngredients	Local	T.P.Neutral		
isPackagingMarkedWithRegulatoryCompliance	Global/Local	T.P.Neutral		
isPackagingMaterialRecoverable	Global/Local	T.P.Neutral		
isPackagingReturnable	Global/Local	T.P.Neutral		
isPackagingSuitableForAirShipment	Global/Local	T.P.Neutral		
isPreCleaningNecessary	Global	T.P.Neutral		
isPermitOrLicenseRequiredToSell	Global/Local	T.P.Neutral		
isPriceOnPack	Global	T.P.Neutral		
isPrimaryFile	Global/Local	T.P.Neutral		
isPrimaryMaterial	Global/Local	T.P.Neutral		
isProductResistantToSurfaceTensionReducingAgent	Global	T.P.Neutral		
isProductClassifiedAsNonHazardous	Global/Local	T.P.Neutral		
isProductCustomizable	Global/Local	T.P.Neutral		
isProhibitedForTransportation	Global/Local	T.P.Neutral		
isRadioFrequencyIDOnPackaging	Global/Local	T.P.Neutral		
isRegulatedForTransportation	Global/Local	T.P.Neutral		
isReprocessedSingleUseDevice	Global/Local	T.P.Neutral		
isReturnableAssetEmpty	Global/Local	T.P.Neutral		
isReusableSurgicalInstrument	Global/Local	T.P.Neutral		
isRindEdible	Global/Local	T.P.Neutral		
isSizeTypeVariant	Global/Local	T.P.Neutral & T.P.Dependent		
isSubstanceOfVeryHighConcern	Global/Local	T.P.Neutral		
isSupplierARegistrant	Global/Local	T.P.Neutral		
isTalentReleaseOnFile	Global	T.P.Neutral		
isTradeItemABaseUnit	Global	T.P.Neutral		
isTradeItemACombinationItem	Global/Local	T.P.Neutral		
isTradeItemAConsumerUnit	Global	T.P.Neutral		
isTradeItemADespatchUnit	Global/Local	T.P.Neutral & T.P.Dependent		
isTradeItemADisplayUnit	Global	T.P.Neutral		
isTradeItemAnInvoiceUnit	Global/Local	T.P.Neutral & T.P.Dependent		
isTradeItemAnOrderableUnit	Global/Local	T.P.Neutral & T.P.Dependent		
isTradeItemAQualityVintageAlcoholProduct	Global/Local	T.P.Neutral & T.P.Dependent		
isTradeItemAService	Global	T.P.Neutral		
isTradeItemAutomaticPowerDownEnabled	Global	T.P.Neutral		
isTradeItemAVariableUnit	Global	T.P.Neutral		
isTradeItemChemicalNotIntendedForHumanConsumption	Global	T.P.Neutral		
isTradeItemConsideredCollectibleOrMemorabilia	Global/Local	T.P.Neutral		
isTradeItemConsideredDopingProduct	Global/Local	T.P.Neutral		

Attribute Name	Target Market Applicability	Trading Partner Neutral status	Multiple Values (Grey = N/A)	Multi Language/ Measurement / Currency
isTradeItemConsideredGeneric	Global/Local	T.P.Neutral		
isTradeItemConsumerUpgradeableOrMaintainable	Global	T.P.Neutral		
isTradeItemDesignedForEasyDisassembly	Global	T.P.Neutral		
isTradeItemDesignedToBeDivisible	Global/Local	T.P.Neutral		
isTradeItemExemptFromDirectPartMarking	Global/Local	T.P.Neutral		
isTradeItemExemptFromSerialisation	Global/Local	T.P.Neutral		
isTradeItemHanging	Global/Local	T.P.Neutral		
isTradeItemImplantable	Global	T.P.Neutral		
isTradeItemMarkedAsRecyclable	Global/Local	T.P.Neutral		
isTradeItemMarkedNoShake	Global/Local	T.P.Neutral		
isTradeItemNonphysical	Global	T.P.Neutral		
istradeItemPackedIrregularly	Global	T.P.Neutral		
isTradeItemAPromotionalUnit	Global/Local	T.P.Neutral & T.P.Dependent		
isTradeItemREACHRelevant	Local	T.P.Neutral		
isTradeItemUnitOfUse	Global/Local	T.P.Neutral		
isTradeItemRecalled	Global/Local	T.P.Neutral		
isTradeItemReconditioned	Global	T.P.Neutral		
isTradeItemRegulatoryCompliant	Global/Local	T.P.Neutral		
isTradeItemReinstated	Global/Local	T.P.Neutral		
isTradeItemReorderable	Global/Local	T.P.Neutral		
isTradeItemRequiredToRemainSterile	Global	T.P.Neutral		
isTradeItemRigidPlasticPackagingContainer	Global	T.P.Neutral		
isTradeItemROHSCompliant	Global	T.P.Neutral		
isTradeItemSeasonal	Local	T.P.Neutral		
isTradeItemShippedInMultipleContainers	Local	T.P.Neutral		
isTradeItemSizeBasedPricing	Global/Local	T.P.Neutral		
isTradeItemUDIDILevel	Global/Local	T.P.Neutral		
isTradeItemUniversalWaste	Global	T.P.Neutral		
isUniversalWaste	Global/Local	T.P.Neutral		
itemDepictionTypeCode	Global	T.P.Neutral		
itemMinimumDurability	Global/Local	T.P.Neutral	No	Yes
itemsInFileDescription	Global	T.P.Neutral	Yes	Yes
itemPeriodSafeToUseAfterOpening	Global/Local	T.P.Neutral	No	Yes
juiceContentPercent	Global/Local	T.P.Neutral		
keyNames	Global/Local	T.P.Neutral		
labelDescription	Global/Local	T.P.Neutral	Yes	Yes
labelledTemperature	Global/Local	T.P.Neutral	Yes	Yes
languageSpecificBrandName	Global/Local	T.P.Neutral	No	Yes
languageSpecificPartyName	Global/Local	T.P.Neutral & T.P.Dependent	No	Yes
languageSpecificSubBrandName	Global/Local	T.P.Neutral	No	Yes
lastChangeDateTime	Global/Local	T.P.Neutral		
lastOrderDateTime	Global/Local	T.P.Neutral		
lastReturnableDateTime	Global/Local	T.P.Neutral		
lastShipDateTime	Global/Local	T.P.Neutral		
laundryDetergentTypeCode	Global/Local	T.P.Neutral & T.P.Dependent	Yes	No
laundryHangingAidTypeCode	Global/Local	T.P.Neutral & T.P.Dependent		
layerHeight	Global	T.P.Neutral	No	No

Attribute Name	Target Market Applicability	Trading Partner Neutral status	Multiple Values (Grey = N/A)	Multi Language/ Measurement / Currency
lensCoatingTypeDescription	Global/Local	T.P.Neutral	Yes	Yes
lensFilterTypeDescription	Global/Local	T.P.Neutral	Yes	Yes
lensTypeDescription	Global/Local	T.P.Neutral	Yes	Yes
lethalConcentration50	Global/Local	T.P.Neutral	No	No
lethalConcentration50Basis	Global/Local	T.P.Neutral	No	No
lethalConcentration50MeasurementPrecision	Global/Local	T.P.Neutral		
lethalDose50	Global/Local	T.P.Neutral	No	No
lethalDose50Basis	Global/Local	T.P.Neutral	No	No
lethalDose50MeasurementPrecision	Global/Local	T.P.Neutral		
lettersAfterNames	Local	T.P.Neutral		
levelOfContainmentCode	Global/Local	T.P.Neutral		
licenseCode	Global/Local	T.P.Neutral	No	No
lightBeamTypeCode	Global	T.P.Neutral		
lightBulbBaseType	Global/Local	T.P.Neutral		
lightBulbDiameterValue	Global/Local	T.P.Neutral	No	Yes
lightBulbFilamentTypeCode	Global/Local	T.P.Neutral		
lightBulbLampTypeCode	Global/Local	T.P.Neutral		
lightBulbShapeCode	Global/Local	T.P.Neutral		
lightBulbTypeDescription	Global/Local	T.P.Neutral	Yes	Yes
lightBulbWarmUpTime	Global/Local	T.P.Neutral	No	Yes
lightOutput	Global/Local	T.P.Neutral	No	Yes
localPackagingMarkedLabelAccreditationCodeReference	Global/Local	T.P.Neutral		
logisticsUnitCubeDimension	Global/Local	T.P.Neutral & T.P.Dependent	No	Yes
logisticsUnitStackingFactor	Global	T.P.Neutral & T.P.Dependent		
longSynopsis	Global/Local	T.P.Neutral	No	Yes
lowerExplosiveLimit	Global	T.P.Neutral		
mainSubject	Global/Local	T.P.Neutral		
manufacturerDeclaredReusabilityTypeCode	Global/Local	T.P.Neutral		
manufacturerOfTradeItem	Global	T.P.Neutral		
manufacturerPreparationTypeCode	Global/Local	T.P.Neutral		
manufacturerSpecifiedAcceptableResterilisationCode	Global/Local	T.P.Neutral		
manufacturerTakeBackProgramFee	Global/Local	T.P.Neutral	No	Yes
mapScale	Global/Local	T.P.Neutral		
marinePollutantTechnicalName	Global/Local	T.P.Neutral		
marketingTradeChannel	Global/Local	T.P.Neutral		
massEquivalentCode	Global/Local	T.P.Neutral		
massEquivalentMeasurement	Global/Local	T.P.Neutral	No	No
massEquivalentProtocolCode	Global/Local	T.P.Neutral		
massEquivalentProtocolDescription	Global/Local	T.P.Neutral	No	Yes
massEquivalentSubstanceCodeReference	Global/Local	T.P.Neutral		
massEquivalentSubstanceDescription	Global/Local	T.P.Neutral	No	Yes
materialAgencyCode	Global	T.P.Neutral		
materialCode	Global	T.P.Neutral		
materialContent	Global	T.P.Neutral	No	Yes
materialCountryOfOrigin	Global/Local	T.P.Neutral		
materialDensity	Global	T.P.Neutral	No	Yes



Attribute Name	Target Market Applicability	Trading Partner Neutral status	Multiple Values (Grey = N/A)	Multi Language/ Measurement / Currency
materialDensityCode	Global/Local	T.P.Neutral		
materialPercentage	Global	T.P.Neutral		
materialStatement	Global	T.P.Neutral	No	Yes
materialThreadCount	Global/Local	T.P.Neutral	No	Yes
materialTreatment	Global/Local	T.P.Neutral	Yes	Yes
materialWeight	Global/Local	T.P.Neutral	No	No
maturationMethodCode	Global/Local	T.P.Neutral		
maximumAge	Global/Local	T.P.Neutral		
minimumAmountOfAnimalProtein	Global	T.P.Neutral	No	Yes
maximumAvailableStorageCapacity	Global/Local	T.P.Neutral	No	Yes
maximumBatteryLife	Global/Local	T.P.Neutral	No	No
maximumColourTemperature	Global/Local	T.P.Neutral	No	Yes
maximumCyclesReusable	Global	T.P.Neutral		
maximumEnvironmentAtmosphericPressure	Global/Local	T.P.Neutral	No	No
maximumFeedingAmount	Global/Local	T.P.Neutral	No	Yes
maximumHumidityAcceptableTimeSpan	Global/Local	T.P.Neutral		
maximumHumidityPercentage	Global/Local	T.P.Neutral		
maximumNumberOfPlayers	Global/Local	T.P.Neutral		
maximumNumberOfSmallestUnitsPerPackage	Global/Local	T.P.Neutral		
maximumOptimumConsumptionTemperature	Global/Local	T.P.Neutral	No	Yes
maximumProcessTemperatureTimeSpan	Global	T.P.Neutral	No	Yes
maximumPH	Global	T.P.Neutral		
maximumResolution	Global/Local	T.P.Neutral	No	Yes
maximumReusableDays	Global/Local	T.P.Neutral		
maximumTemperature	Global/Local	T.P.Neutral	No	No
maximumTemperatureAcceptableTimeSpan	Global/Local	T.P.Neutral		
maximumTerpeneContent	Global/Local	T.P.Neutral & T.P.Dependent	No	No
maximumToleranceTemperature	Global/Local	T.P.Neutral	No	No
maximumWeightOfAnimalBeingFed	Global/Local	T.P.Neutral	No	Yes
measurementPrecisionCode	Global/Local	T.P.Neutral		
meatPoultryCut	Global/Local	T.P.Neutral	No	Yes
medicalDeviceSoftwareCode	Global/Local	T.P.Neutral		
meshMaterialCode	Global/Local	T.P.Neutral		
meshSizeCode	Global/Local	T.P.Neutral		
microbiologicalOrganismCode	Global/Local	T.P.Neutral		
microbiologicalOrganismMaximumValue	Global/Local	T.P.Neutral	No	Yes
microbiologicalOrganismMaximumValueBasis	Global/Local	T.P.Neutral	No	Yes
microbiologicalOrganismMaximumValuePrecisionCode	Global/Local	T.P.Neutral		
microbiologicalOrganismMethodOfAnalysisCode	Global/Local	T.P.Neutral		
microbiologicalOrganismMinimumValue	Global/Local	T.P.Neutral	No	Yes
microbiologicalOrganismReferenceValue	Global/Local	T.P.Neutral	No	Yes
microbiologicalOrganismReferenceValueBasis	Global/Local	T.P.Neutral	No	Yes
microbiologicalOrganismReferenceValuePrecisionCode	Global/Local	T.P.Neutral		
microbiologicalOrganismStrainCode	Global	T.P.Neutral		
microbiologicalOrganismWarningValue	Global/Local	T.P.Neutral	No	Yes
microbiologicalOrganismWarningValueBasis	Global/Local	T.P.Neutral	No	Yes

Attribute Name	Target Market Applicability	Trading Partner Neutral status	Multiple Values (Grey = N/A)	Multi Language/ Measurement / Currency
microbiologicalOrganismWarningValuePrecisionCode	Global/Local	T.P.Neutral		
microphoneTypeCode	Global/Local	T.P.Neutral		
minimumAge	Global/Local	T.P.Neutral		
minimumColourTemperature	Global/Local	T.P.Neutral	No	Yes
minimumEnvironmentAtmosphericPressure	Global/Local	T.P.Neutral	No	No
minimumFeedingAmount	Global/Local	T.P.Neutral	No	Yes
minimumFishMeatPoultryContent	Global/Local	T.P.Neutral	No	Yes
minimumHumidityPercentage	Global/Local	T.P.Neutral		
minimumNumberOfPlayers	Global/Local	T.P.Neutral		
minimumOptimumConsumptionTemperature	Global/Local	T.P.Neutral	No	Yes
minimumProcessTemperatureTimeSpan	Global	T.P.Neutral	No	Yes
minimumOrderValue	Global/Local	T.P.Neutral & T.P.Dependent	No	Yes
minimumPH	Global	T.P.Neutral		
minimumTemperature	Global/Local	T.P. Neutral	No	No
minimumTerpeneContent	Global/Local	T.P.Neutral & T.P.Dependent	No	No
minimumToleranceTemperature	Global/Local	T.P.Neutral	No	No
minimumTradeItemLifespanFromTimeOfArrival	Global/Local	T.P.Neutral & T.P.Dependent		
minimumTradeItemLifespanFromTimeOfProduction	Global/Local	T.P.Neutral & T.P.Dependent		
minimumWeightOfAnimalBeingFed	Global/Local	T.P.Neutral	No	Yes
mountLocationDescription	Global/Local	T.P.Neutral	Yes	Yes
mountTypeDescription	Global/Local	T.P.Neutral	Yes	Yes
mRICompatibilityCode	Global	T.P.Neutral		
multiComponentDeviceTypeCode	Global/Local	T.P.Neutral		
multiPictureDisplayCapabilityTypeCode	Global/Local	T.P.Neutral		
multipleContainerQuantity	Global/Local	T.P.Neutral		
multilayerFilmMaterialCompositionCode	Global	T.P.Neutral		
musicPerformanceType	Global/Local	T.P.Neutral		
nameAsSubject	Global/Local	T.P.Neutral		
namesAfterKey	Global/Local	T.P.Neutral		
namesBeforeKey	Global/Local	T.P.Neutral		
nameTypeCode	Global/Local	T.P.Neutral		
necessaryTradeItemToUseDescription	Global/Local	T.P.Neutral	No	Yes
necklaceTypeCode	Global/Local	T.P.Neutral	Yes	No
neckwearTypeCode	Global/Local	T.P.Neutral		
nestingDirectionCode	Global	T.P.Neutral		
nestingIncrement	Global	T.P.Neutral	Yes	Yes
nestingTypeCode	Global	T.P.Neutral		
netContent	Global	T.P.Neutral	No	Yes
netContentStatement	Global/Local	T.P.Neutral	No	Yes
netDueTimePeriod	Global/Local	T.P.Neutral & T.P.Dependent	No	No
netMassOfExplosives	Global/Local	T.P.Neutral	No	No
netWeight (NonGTINLogisticsUnitInformation)	Global/Local	T.P.Neutral & T.P.Dependent	No	No
netWeight (TradeItemWeight)	Global/Local	T.P.Neutral	No	No
nominalInsideDiameter	Global/Local	T.P.Neutral	No	No
nominalOutsideDiameter	Global/Local	T.P.Neutral	No	No
noncreditableGrainAmount	Global/Local	T.P.Neutral	No	Yes



Attribute Name	Target Market Applicability	Trading Partner Neutral status	Multiple Values (Grey = N/A)	Multi Language/ Measurement / Currency
noncreditableGrainDescription	Global/Local	T.P.Neutral	No	Yes
nonfoodIngredientCodeReference	Global/Local	T.P.Neutral		
nonfoodIngredientDefinition	Global/Local	T.P.Neutral	Yes	Yes
nonfoodingredientName	Global/Local	T.P.Neutral	No	Yes
nonfoodIngredientOfConcernCode	Global/Local	T.P.Neutral		
nonfoodIngredientPurpose	Global/Local	T.P.Neutral	Yes	Yes
nonfoodIngredientStatement	Global/Local	T.P.Neutral	Yes	Yes
nonhazardousWasteDescription	Global/Local	T.P.Neutral	Yes	Yes
nonMarkedTradeItemComponents	Global/Local	T.P.Neutral	No	Yes
nonPromotionalTradeItem	Global/Local	T.P.Neutral		
noteToPhysician	Global/Local	T.P.Neutral	No	Yes
numberOfCyclesPriorToWithdrawal	Global/Local	T.P.Neutral		
numberOfDesignationUnits	Global/Local	T.P.Neutral & T.P.Dependent		
numberOfDividersHorizontal	Global/Local	T.P.Neutral		
numberOfDividersVertical	Global/Local	T.P.Neutral		
numberOfEpisodes	Global/Local	T.P.Neutral		
numberOfFacilitiesInStressedWaterArea	Global/Local	T.P.Neutral		
numberOfIllustratedPages	Global/Local	T.P.Neutral		
numberOfIllustrations	Global/Local	T.P.Neutral		
numberOfItemsInDigitalAsset	Global	T.P.Neutral		
numberOfPackagesForSetPiecesGTIN	Global/Local	T.P.Neutral		
numberOfPackagingElementUnits	Global/Local	T.P.Neutral & T.P.Dependent		
numberOfPiecesInSet	Global/Local	T.P.Neutral		
numberOfRibs	Global/Local	T.P.Neutral & T.P.Dependent	No	No
numberOfServingsPerPackage	Global/Local	T.P.Neutral		
numberOfServingsPerPackageMeasurementPrecisionCode	Global/Local	T.P.Neutral		
numberOfServingsRangeDescription	Global/Local	T.P.Neutral	No	Yes
numberOfSmallestUnitsPerPackage	Global/Local	T.P.Neutral		
numberOfWheels	Global/Local	T.P.Neutral		
nutrientBasisQuantity	Global/Local	T.P.Neutral	No	No
nutrientBasisQuantityDescription	Global/Local	T.P.Neutral	No	Yes
nutrientBasisQuantityTypeCode	Global/Local	T.P.Neutral		
nutrientFormatTypeCodeReference	Global/Local	T.P.Neutral		
nutrientGroupCode	Global/Local	T.P.Neutral		
nutrientNameOnPackage	Global/Local	T.P.Neutral & T.P.Dependent	No	Yes
nutrientRelevantDataProvidedDateTime	Global/Local	T.P.Neutral		
nutrientSource	Global/Local	T.P.Neutral & T.P.Dependent	No	Yes
nutrientTypeCode	Global/Local	T.P.Neutral		
nutrientValueDerivationCode	Global/Local	T.P.Neutral		
nutritionalLabelTypeCode	Global/Local	T.P.Neutral		
nutritionalProgramCode	Global/Local	T.P.Neutral		
nutritionalProgramDetail	Global/Local	T.P.Neutral	Yes	Yes
nutritionalProgramIngredientMeasurement	Global/Local	T.P.Neutral	No	Yes
nutritionalProgramIngredientTypeCode	Global/Local	T.P.Neutral		
nutritionalProgramStatusCode	Global/Local	T.P.Neutral		
nutritionalScore	Global/Local	T.P.Neutral		

Attribute Name	Target Market Applicability	Trading Partner Neutral status	Multiple Values (Grey = N/A)	Multi Language/ Measurement / Currency
nutritionalScoreProductCategoryCode	Global/Local	T.P.Neutral		
nutritionalValue	Global/Local	T.P.Neutral		
offerOnPack	Local	T.P.Neutral		
onixProductAvailabilityCode	Global/Local	T.P.Neutral		
opacityTypeCode	Global/Local	T.P.Neutral		
openedTradeItemLifeSpan	Global	T.P.Neutral		
orderableReturnableConditionsCode	Global/Local	T.P.Neutral		
orderingLeadTime	Global/Local	T.P.Neutral & T.P.Dependent	No	Yes
orderingUnitOfMeasure	Global/Local	T.P.Neutral & T.P.Dependent		
orderQuantityMaximum	Global/Local	T.P.Neutral & T.P.Dependent		
orderQuantityMinimum	Global/Local	T.P.Neutral & T.P.Dependent		
orderQuantityMultiple	Global/Local	T.P.Neutral & T.P.Dependent		
orderSizingFactor	Global/Local	T.P.Neutral & T.P.Dependent	No	Yes
organicCertificationIdentification	Global/Local	T.P.Neutral		
organicCertificationEffectiveEndDateTime	Global/Local	T.P.Neutral		
organicCertificationEffectiveStartDateTime	Global/Local	T.P.Neutral		
organicClaimAgencyCode	Global/Local	T.P.Neutral		
organicClaimAgencyName	Global/Local	T.P.Neutral		
organicClaimAgencyTypeCode	Global/Local	T.P.Neutral		
organicPercentClaim	Global/Local	T.P.Neutral		
organicProductPlaceOfFarmingCode	Global/Local	T.P.Neutral		
organicTradeItemCode	Global/Local	T.P.Neutral		
orientationPreferenceSequence	Global	T.P.Neutral		
orientationTypeCode	Global	T.P.Neutral		
originalLanguageCode	Global/Local	T.P.Neutral		
originOfWineCode	Global/Local	T.P.Neutral & T.P.Dependent		
packingProcessMethodCode	Global/Local	T.P.Neutral		
packagedProductWastagePercent	Global/Local	T.P.Neutral		
packagedUnpackagedShelfLifeRatio	Global/Local	T.P.Neutral		
packagingChainOfCustodyEventSequenceNumber	Global/Local	T.P.Neutral		
packagingChainOfCustodySourceCertifiedCode	Global/Local	T.P.Neutral		
packagingClaimElementCode	Global/Local	T.P.Neutral & T.P.Dependent		
packagingClaimTypeCode	Global/Local	T.P.Neutral & T.P.Dependent		
packagingComponentDescription	Global/Local	T.P.Neutral	No	Yes
packagingCompositeMaterialDescription	Global/Local	T.P.Neutral	No	Yes
packagingConstituent	Global/Local	T.P.Neutral	No	Yes
packagingCubeUtilisationRatio	Global/Local	T.P.Neutral		
packagingDepth	Global/Local	T.P.Neutral	No	No
packagingFeatureCode	Global/Local	T.P.Neutral		
packagingFunctionCode	Global/Local	T.P.Neutral		
packagingGeneratedMaterialWaste	Global/Local	T.P.Neutral	No	No
packagingHeight	Global/Local	T.P.Neutral	No	No
packagingLabellingTypeCode	Global/Local	T.P.Neutral		

Attribute Name	Target Market Applicability	Trading Partner Neutral status	Multiple Values (Grey = N/A)	Multi Language/ Measurement / Currency
packagingLabellingCoveragePercentage	Global/Local	T.P.Neutral		
packagingLevel	Global/Local	T.P.Neutral		
packagingLevelTypeCode	Global/Local	T.P.Neutral		
packagingMarkedLabelAccreditationCode	Global/Local	T.P.Neutral		
packagingMarkedLanguageCode	Global/Local	T.P.Neutral		
packagingMarkedNutritionLabelCode	Global/Local	T.P.Neutral		
packagingMarkedRecyclableScheme	Local	T.P.Neutral		
packagingMaterialAdhesiveAmount	Global/Local	T.P.Neutral	No	Yes
packagingMaterialAdhesiveTypeCode	Global/Local	T.P.Neutral		
packagingMaterialAdhesiveSolubilityTypeCode	Global/Local	T.P.Neutral		
packagingMaterialAppliedProcessCode	Global/Local	T.P.Neutral		
packagingMaterialClassificationCodeReference	Global/Local	T.P.Neutral		
packagingMaterialCoatingTypeDescription	Global/Local	T.P.Neutral	Yes	Yes
packagingMaterialColourCodeReference	Global/Local	T.P.Neutral		
packagingMaterialCompositionQuantity	Global/Local	T.P.Neutral	No	Yes
packagingMaterialDensity	Global	T.P.Neutral	No	Yes
packagingMaterialDescription	Global/Local	T.P.Neutral	No	Yes
packagingMaterialElementCode	Global/Local	T.P.Neutral		
packagingMaterialLaunchDateTime	Global/Local	T.P.Neutral		
packagingMaterialRecyclingSchemeCode	Global/Local	T.P.Neutral		
packagingMaterialPerformanceCode	Global/Local	T.P.Neutral		
packagingMaterialThickness	Global/Local	T.P.Neutral	No	No
packagingMaterialTypeCode	Global/Local	T.P.Neutral		
packagingOwnerIdentification	Global/Local	T.P.Neutral		
packagingOwnerName	Global/Local	T.P.Neutral		
packagingRawMaterialCode	Global/Local	T.P.Neutral		
packagingRawMaterialContentPercentage	Global/Local	T.P.Neutral		
packagingRecoveryRate	Global/Local	T.P.Neutral		
packagingRecoveryRateDescription	Global/Local	T.P.Neutral	No	Yes
packagingRecoveryRateTypeCode	Global/Local	T.P.Neutral		
packagingRecycledContentDescription	Global/Local	T.P.Neutral	No	Yes
packagingRecyclabilityAssessmentSpecificationCode	Global/Local	T.P.Neutral & T.P.Dependent		
packagingRecyclabilityValue	Global/Local	T.P.Neutral & T.P.Dependent	No	Yes
packagingRecyclabilityValueEffectiveDate	Global/Local	T.P.Neutral & T.P.Dependent	No	No
packagingRecycledContentRatio	Global/Local	T.P.Neutral		
packagingRecycledContentTypeCode	Global/Local	T.P.Neutral		
packagingRecyclingProcessTypeCode	Global/Local	T.P.Neutral		
packagingRecyclingSchemeCode	Global/Local	T.P.Neutral		
packagingRefundObligationName	Global/Local	T.P.Neutral		
packagingRefuseObligationName	Global/Local	T.P.Neutral		
packagingRenewableContentDescription	Global/Local	T.P.Neutral	No	Yes
packagingRenewableContentRatio	Global/Local	T.P.Neutral		
packagingRenewableContentTypeCode	Global/Local	T.P.Neutral		
packagingReusabilityStandardCode	Global/Local	T.P.Neutral		
packagingReusabilityStandardDescription	Global/Local	T.P.Neutral	No	Yes
packagingReuseRate	Global/Local	T.P.Neutral		

Attribute Name	Target Market Applicability	Trading Partner Neutral status	Multiple Values (Grey = N/A)	Multi Language/ Measurement / Currency
packagingShapeCode	Global/Local	T.P.Neutral		
packagingSustainabilityFeatureCode	Global/Local	T.P.Neutral		
packagingSustainabilityStatement	Global/Local	T.P.Neutral	Yes	Yes
packagingTermsAndConditionsCode	Global	T.P.Neutral		
packagingToTradeItemWeightRatio	Global/Local	T.P.Neutral		
packagingTypeCode	Global	T.P.Neutral		
packagingTypeDescription	Global	T.P.Neutral	No	Yes
packagingWeight	Global/Local	T.P.Neutral	No	No
packagingWeightPerConsumerUse	Global/Local	T.P.Neutral	No	Yes
packagingWeightReduction	Global/Local	T.P.Neutral	No	No
packagingWeightReductionProtocolName	Global/Local	T.P.Neutral	No	Yes
packagingWidth	Global/Local	T.P.Neutral	No	No
pantsShortsTypeCode	Global/Local	T.P.Neutral		
partyRole	Global/Local	T.P.Neutral		
patternCode	Global	T.P.Neutral		
paymentDueBasisTypeCode	Global/Local	T.P.Neutral & T.P.Dependent		
paymentMethodCode	Global/Local	T.P.Neutral & T.P.Dependent		
paymentTermsTypeCode	Global/Local	T.P.Neutral & T.P.Dependent		
payPerViewWindow	Global/Local	T.P.Neutral		
pegHoleNumber	Global/Local	T.P.Neutral		
pegHoleTypeCode	Global/Local	T.P.Neutral		
pegHorizontal	Global/Local	T.P.Neutral	No	No
pegVertical	Global/Local	T.P.Neutral	No	No
percentageOfAlcoholByVolume	Global/Local	T.P.Neutral		
percentageOfAlcoholByVolumeMeasurement PrecisionCode	Global/Local	T.P.Neutral	No	No
permitEndDateTime	Global/Local	T.P.Neutral		
permitStartDateTime	Global/Local	T.P.Neutral		
personName	Global/Local	T.P.Neutral		
personNameInverted	Global/Local	T.P.Neutral		
physicalFormDescription	Global	T.P.Neutral	No	Yes
physicalResourceTypeCode	Global/Local	T.P.Neutral		
physicalResourceUsage	Global/Local	T.P.Neutral	No	No
physicalResourceUsageAgencyCodeReference	Global/Local	T.P.Neutral		
physicalResourceUsageClassificationCodeReference	Global/Local	T.P.Neutral		
physicalResourceUsageMeasurementBasis	Global/Local	T.P.Neutral	No	No
physicalResourceUsageMeasurementTypeCode	Global/Local	T.P.Neutral		
physicalResourceUsageRatingScaleCodeReference	Global/Local	T.P.Neutral		
physicalResourceUsageSubclassificationCodeReference	Global/Local	T.P.Neutral		
physicalStateCode	Global/Local	T.P.Neutral		
physiochemicalCharacteristicCode	Global/Local	T.P.Neutral		
physiochemicalCharacteristicReferenceValue	Global/Local	T.P.Neutral	No	Yes
physiochemicalCharacteristicReferenceValue Basis	Global/Local	T.P.Neutral	No	Yes
physiochemicalCharacteristicReferenceValue PrecisionCode	Global/Local	T.P.Neutral		
physiochemicalCharacteristicValue	Global/Local	T.P.Neutral	No	Yes

Attribute Name	Target Market Applicability	Trading Partner Neutral status	Multiple Values (Grey = N/A)	Multi Language/ Measurement / Currency
physiochemicalCharacteristicValueBasis	Global/Local	T.P.Neutral	No	Yes
physiochemicalCharacteristicValuePrecisionCode	Global/Local	T.P.Neutral		
physiochemicalCharacteristicWarningValue	Global/Local	T.P.Neutral	No	Yes
physiochemicalCharacteristicWarningValueBasis	Global/Local	T.P.Neutral	No	Yes
physiochemicalCharacteristicWarningValuePrecisionCode	Global/Local	T.P.Neutral		
pillowShapeCode	Global/Local	T.P.Neutral	Yes	No
pipeScheduleIdentification	Global/Local	T.P.Neutral		
placementOfDivider	Global/Local	T.P.Neutral		
platformTermsAndConditionsCode	Global/Local	T.P.Neutral		
platformTypeCode	Global/Local	T.P.Neutral		
plumbingControlTypeCode	Global/Local	T.P.Neutral		
plumbingHVACConnectionAgencyCode	Global/Local	T.P.Neutral		
plumbingHVACConnectionCode	Global/Local	T.P.Neutral		
plumbingHVACConnectionTypeCode	Global/Local	T.P.Neutral		
poBox	Global/Local	T.P.Neutral & T.P.Dependent		
postConsumerRecycledContentPercentage	Global/Local	T.P.Neutral		
postHarvestTreatmentCode	Global/Local	T.P.Neutral		
postProcessTradeItemTreatmentPhysicalCode	Global/Local	T.P.Neutral		
postalCode	Global/Local	T.P.Neutral & T.P.Dependent		
powerSupplyTypeCode	Global/Local	T.P.Neutral		
precautionaryStatementsCode	Global/Local	T.P.Neutral		
precautionaryStatementsDescription	Global/Local	T.P.Neutral	No	Yes
prefixToKey	Global/Local	T.P.Neutral		
preliminaryItemStatusCode	Global/Local	T.P.Neutral		
preparationConsumptionPrecautions	Global/Local	T.P.Neutral	No	Yes
preparationInstructions	Global/Local	T.P.Neutral	No	Yes
preparationStateCode	Global/Local	T.P.Neutral		
prescriptionTypeCode	Global/Local	T.P.Neutral		
preservationTechniqueCode	Global/Local	T.P.Neutral		
previousPackagingWeight	Global/Local	T.P.Neutral	No	No
priceBasisQuantity	Global/Local	T.P.Neutral	No	No
priceByMeasureTypeCode	Global/Local	T.P.Neutral & T.P.Dependent		
priceComparisonContentTypeCode	Global/Local	T.P.Neutral		
priceComparisonMeasurement	Global/Local	T.P.Neutral	No	Yes
priceEffectiveEndDate	Global/Local	T.P.Neutral		
priceEffectiveStartDate	Global/Local	T.P.Neutral		
primaryAddedFlavouringCode	Global/Local	T.P.Neutral		
productActivityRegionDescription	Global/Local	T.P.Neutral	Yes	Yes
productActivityRegionZoneCodeReference	Global/Local	T.P.Neutral		
productActivityTypeCode	Global/Local	T.P.Neutral		
productCharacteristicCode	Global/Local	T.P.Neutral		
productCharacteristicSequenceNumber	Global/Local	T.P.Neutral		
productCharacteristicValueAmount	Global/Local	T.P.Neutral	No	Yes
productCharacteristicValueCode	Global/Local	T.P.Neutral		
productCharacteristicValueDateTime	Global/Local	T.P.Neutral		
productCharacteristicValueDescription	Global/Local	T.P.Neutral	No	Yes

Attribute Name	Target Market Applicability	Trading Partner Neutral status	Multiple Values (Grey = N/A)	Multi Language/ Measurement / Currency
productCharacteristicValueInteger	Global/Local	T.P.Neutral		
productCharacteristicValueMeasurement	Global/Local	T.P.Neutral	No	Yes
productCharacteristicValueNumeric	Global/Local	T.P.Neutral		
productCharacteristicValueString	Global/Local	T.P.Neutral		
productFormulationStatementDescription	Global/Local	T.P.Neutral	Yes	Yes
productFormulationStatementRegulatoryBodyCode	Global/Local	T.P.Neutral		
productInformationLegalDisclaimer	Global/Local	T.P.Neutral	No	Yes
productionMethodForFishAndSeafoodCode	Global/Local	T.P.Neutral		
productionVariantCancelledDateTime	Global/Local	T.P.Neutral & T.P.Dependent		
productionVariantDescription	Global/Local	T.P.Neutral & T.P.Dependent	No	Yes
productionVariantDiscontinuedDateTime	Global/Local	T.P.Neutral & T.P.Dependent		
productionVariantEffectiveDateTime	Global/Local	T.P.Neutral & T.P.Dependent		
productRange	Global	T.P.Neutral		
productTextureAgencyCode	Global	T.P.Neutral		
productTexturalCharacteristics	Global	T.P.Neutral	No	Yes
productTextureCode	Global	T.P.Neutral		
productUsageBodyLocationCode	Global/Local	T.P.Neutral & T.P.Dependent		
productYield	Global/Local	T.P.Neutral	No	No
productYieldTypeCode	Global/Local	T.P.Neutral		
productYieldVariationPercentage	Global/Local	T.P.Neutral		
professionalAffiliation	Global/Local	T.P.Neutral		
prohibitedForTransportationReason	Global/Local	T.P.Neutral	Yes	Yes
promotionTypeCode	Global/Local	T.P.Neutral		
proofOfOptimizedPackagingWeightStandardCode	Global/Local	T.P.Neutral		
proofOfOptimizedPackagingWeightStandardDescription	Global/Local	T.P.Neutral	No	Yes
proofOfPackagingWeightReductionDescription	Global/Local	T.P.Neutral	No	Yes
propertyAmount	Global/Local	T.P.Neutral	No	No
propertyCode	Global/Local	T.P.Neutral		
propertyDateTime	Global/Local	T.P.Neutral		
propertyDescription	Global/Local	T.P.Neutral	No	Yes
propertyFloat	Global/Local	T.P.Neutral		
propertyInteger	Global/Local	T.P.Neutral		
propertyMeasurement	Global/Local	T.P.Neutral	No	Yes
propertyString	Global/Local	T.P.Neutral		
protectiveEquipment	Global/Local	T.P.Neutral	No	Yes
protectiveEquipmentAdditionalDescription	Global/Local	T.P.Neutral	No	Yes
protectiveEquipmentBodyAreaCode	Global/Local	T.P.Neutral		
protectiveEquipmentStatusCode	Global/Local	T.P.Neutral		
provinceStateCode	Global/Local	T.P.Neutral & T.P.Dependent		
provenanceStatement	Global/Local	T.P.Neutral	Yes	Yes
proximoCutOffDay	Global/Local	T.P.Neutral & T.P.Dependent		
psychotropicSubstance	Global/Local	T.P.Neutral		
publicationDateTime	Global/Local	T.P.Neutral & T.P.Dependent		

Attribute Name	Target Market Applicability	Trading Partner Neutral status	Multiple Values (Grey = N/A)	Multi Language/ Measurement / Currency
publicationDateTypeCode	Global/Local	T.P.Neutral		
publicationDescriptionTypeCode	Global/Local	T.P.Neutral		
publicationLocation	Global/Local	T.P.Neutral & T.P.Dependent		
publisherName	Global/Local	T.P.Neutral		
publishingRoleCode	Global/Local	T.P.Neutral		
publishingStatusCode	Global/Local	T.P.Neutral		
quantityContained	Global/Local	T.P.Neutral	No	Yes
quantityOfBatteriesBuiltIn	Global/Local	T.P.Neutral		
quantityOfBatteriesIncluded	Global/Local	T.P.Neutral		
quantityOfBatteriesRequired	Global/Local	T.P.Neutral		
quantityOfChildren	Global	T.P.Neutral		
quantityOfCompleteLayersContainedInATradeItem	Global	T.P.Neutral		
quantityOfFunctionalBasisUnit	Global/Local	T.P.Neutral	No	No
quantityOfInnerPack	Global	T.P.Neutral		
quantityOfLayersPerPallet	Global/Local	T.P.Neutral & T.P.Dependent		
quantityOfNextLevelTradeItemWithinInnerPack	Global	T.P.Neutral		
quantityOfNextLowerLevelTradeItem	Global	T.P.Neutral		
quantityOfTradeItemsContainedInACompleteLayer	Global	T.P.Neutral		
quantityOfTradeItemsPerPallet	Global/Local	T.P.Neutral & T.P.Dependent		
quantityOfTradeItemsPerPalletLayer	Global/Local	T.P.Neutral & T.P.Dependent		
rankBelowSpecies	Global	T.P.Neutral		
ratingContentDescriptorCode	Global/Local	T.P.Neutral		
rawMaterialCode	Global/Local	T.P.Neutral & T.P.Dependent		
rawMaterialContentPercentage	Global/Local	T.P.Neutral & T.P.Dependent		
rawMaterialIrradiatedCode	Global/Local	T.P.Neutral		
rawMaterialUsedInPreparationWeight	Global/Local	T.P.Neutral	No	No
rEACHChemicalProductUseDescriptorCode	Local	T.P.Neutral		
reachChemicalRegistrationNumber	Local	T.P.Neutral		
rEACHEnvironmentReleaseUseCategoryCode	Local	T.P.Neutral		
rEACHProcessUseDescriptorCode	Local	T.P.Neutral		
rEACHSectorUseDescriptorCode	Local	T.P.Neutral		
recallPrecision	Global/Local	T.P.Neutral & T.P.Dependent	No	Yes
recallScopeTypeCode	Global/Local	T.P.Neutral & T.P.Dependent		
recipe	Global/Local	T.P.Neutral	Yes	Yes
recommendedConsumerPickupAreaCode	Global/Local	T.P.Neutral		
recommendedFrequencyOfFeeding	Global/Local	T.P.Neutral	No	Yes
recommendedUsageLocation	Global/Local	T.P.Neutral	No	Yes
referencedFileTypeCode	Global/Local	T.P.Neutral		
referencedTradeItemTypeCode	Global/Local	T.P.Neutral & T.P.Dependent		
registrationAgency	Global/Local	T.P.Neutral		
registrationEndDateTime	Global/Local	T.P.Neutral		
registrationNumber	Global/Local	T.P.Neutral		
regulatorApprovalDate	Global/Local	T.P.Neutral	No	No



Attribute Name	Target Market Applicability	Trading Partner Neutral status	Multiple Values (Grey = N/A)	Multi Language/ Measurement / Currency
regulatedChemicalDescription	Global/Local	T.P.Neutral	No	Yes
regulatedChemicalIdentifierCodeReference	Global/Local	T.P.Neutral		
regulatedChemicalName	Global/Local	T.P.Neutral		
regulatedChemicalSunsetDateTime	Global/Local	T.P.Neutral		
regulatedChemicalTypeCode	Global/Local	T.P.Neutral & T.P.Dependent		
regulatedProductName	Global/Local	T.P.Neutral	Yes	Yes
regulationCommunityLevelCode	Global/Local	T.P.Neutral		
regulationLevelCodeReference	Global/Local	T.P.Neutral	Yes	No
regulationPictogramOrWarningQuantity	Global/Local	T.P.Neutral		
regulationRestrictionCommunityIdentifier	Global/Local	T.P.Neutral		
regulationRestrictionsAndDescriptors	Global/Local	T.P.Neutral	Yes	Yes
regulationTypeCode	Global/Local	T.P.Neutral		
regulatoryAct	Global/Local	T.P.Neutral		
regulatoryActComplianceLevelCode	Global/Local	T.P.Neutral		
regulatoryAgency	Global/Local	T.P.Neutral		
regulatoryPermitIdentification	Global/Local	T.P.Neutral		
relevantSupportingSubstanceHazardousDocumentation	Global/Local	T.P.Neutral	No	Yes
remoteControlTypeCode	Global/Local	T.P.Neutral		
renewablePlantBasedPlasticComponentsPercent	Global	T.P.Neutral		
rennetTypeCode	Global/Local	T.P.Neutral		
reportableQuantityTechnicalName	Global/Local	T.P.Neutral		
requiredEducationTrainingTypeCode	Global/Local	T.P.Neutral	Yes	No
requiredHardwarePerformance	Global/Local	T.P.Neutral	No	No
requiredStorageCapacity	Global/Local	T.P.Neutral	No	No
requiredSystemMemoryCapacity	Global/Local	T.P.Neutral	No	No
requiredVideoMemoryCapacity	Global/Local	T.P.Neutral	No	No
resolutionTypeCode	Global/Local	T.P.Neutral		
restOfWorldSalesRightsType	Global/Local	T.P.Neutral		
restrictionDescription	Global/Local	T.P.Neutral	No	Yes
returnableAssetCapacityContent	Global/Local	T.P.Neutral	No	Yes
resultingHairColourShadeCode	Global/Local	T.P.Neutral		
returnableAssetOwnerId	Global/Local	T.P.Neutral		
returnableAssetOwnerName	Global/Local	T.P.Neutral		
returnableAssetsContainedQuantity	Global/Local	T.P.Neutral	No	Yes
returnablePackageDepositAmount	Global/Local	T.P.Neutral & T.P.Dependent	No	No
returnablePackageDepositIdentification	Global/Local	T.P.Neutral		
returnablePackageDepositRegion	Global/Local	T.P.Neutral		
returnGoodsPolicyCode	Global/Local	T.P.Neutral & T.P.Dependent		
reuseInstructions	Global/Local	T.P.Neutral	No	No
ringTypeCode	Global/Local	T.P.Neutral	Yes	No
ripeningTimePeriod	Global/Local	T.P.Neutral	No	No
riskPhraseCode	Global/Local	T.P.Neutral		
rOHSComplianceFailureMaterial	Local	T.P.Neutral		
routeOfAdministration	Global/Local	T.P.Neutral		
routeOfExposureCode	Global/Local	T.P.Neutral		
rugTypeCode	Global/Local	T.P.Neutral	Yes	No
runModeCode	Global	T.P.Neutral		

Attribute Name	Target Market Applicability	Trading Partner Neutral status	Multiple Values (Grey = N/A)	Multi Language/ Measurement / Currency
runTimeMinutes	Global/Local	T.P.Neutral		
safetyPhraseCode	Global/Local	T.P.Neutral		
salesConditionTargetMarketCountry	Global/Local	T.P.Neutral		
salesRightsTypeCode	Global/Local	T.P.Neutral		
salesTerritory	Global/Local	T.P.Neutral		
saltMoistureContentCode	Global/Local	T.P.Neutral	No	No
screenRefreshRate	Global/Local	T.P.Neutral		
sDSSheetEffectiveDateTime	Global/Local	T.P.Neutral		
sDSSheetNumber	Global	T.P.Neutral		
sDSSheetVersion	Global/Local	T.P.Neutral		
sDSStandardCode	Global/Local	T.P.Neutral		
sDSStandardVersion	Global/Local	T.P.Neutral		
seamsCode	Global/Local	T.P.Neutral	Yes	No
seasonalAvailabilityEndDateTime	Local	T.P.Neutral		
seasonalAvailabilityStartDateTime	Local	T.P.Neutral		
seasonCalendarYear	Local	T.P.Neutral		
seasonName	Local	T.P.Neutral	Yes	Yes
seasonParameterCode	Local	T.P.Neutral		
secondaryAddedFlavouringCode	Global/Local	T.P.Neutral		
securityTagLocationCode	Local	T.P.Neutral		
securityTagTypeCode	Local	T.P.Neutral		
selfTimerDelay	Global/Local	T.P.Neutral	Yes	No
sellingUnitOfMeasure	Global/Local	T.P.Neutral		
sequenceNumber	Local	T.P.Neutral		
serialNumberLocationCode	Global	T.P.Neutral		
servingSize	Global/Local	T.P.Neutral	No	Yes
servingSizeDescription	Global/Local	T.P.Neutral	No	Yes
servingsPerPackageDescription	Global/Local	T.P.Neutral	No	Yes
servingSuggestion	Global/Local	T.P.Neutral	No	Yes
shearStrength	Global/Local	T.P.Neutral	No	Yes
sheetName	Global/Local	T.P.Neutral		
shippingContainerQuantity	Global/Local	T.P.Neutral & T.P.Dependent	No	Yes
shippingContainerQuantityDescription	Global/Local	T.P.Neutral	Yes	Yes
shippingContainerTypeCode	Global/Local	T.P.Neutral		
shippingQuantityMinimum	Global/Local	T.P.Neutral & T.P.Dependent		
shippingRegulationException	Global/Local	T.P.Neutral	No	Yes
shortSynopsis	Global/Local	T.P.Neutral	No	Yes
shortTradeItemMarketingMessage	Global/Local	T.P.Neutral & T.P.Dependent	Yes	Yes
signalProcessingTypeCode	Global/Local	T.P.Neutral		
sizeCode	Global	T.P.Neutral		
sizeDimension	Global	T.P.Neutral	No	No
sizeGroupCode	Global	T.P.Neutral		
sizeSystemCode	Global	T.P.Neutral		
sizeTermDescription	Global/Local	T.P.Neutral	No	Yes
sizeTypeCode	Global	T.P.Neutral		
skirtTypeCode	Global	T.P.Neutral		
sleeveType	Global/Local	T.P.Neutral	No	Yes
softwareCategoryTypeDescription	Global/Local	T.P.Neutral	Yes	Yes

Attribute Name	Target Market Applicability	Trading Partner Neutral status	Multiple Values (Grey = N/A)	Multi Language/ Measurement / Currency
sourceAnimalCode	Global/Local	T.P.Neutral		
sourceCertificationSystemProtocolCode	Global/Local	T.P.Neutral		
sourceCertificationSystemProtocolDescription	Global/Local	T.P.Neutral	No	Yes
sourceName	Global/Local	T.P.Neutral		
sparePartsAvailabilityEffectiveDateTypeCode	Global/Local	T.P.Neutral & T.P.Dependent		
sparePartsAvailabilityPeriod	Global/Local	T.P.Neutral & T.P.Dependent		
specialDeviceTypeCode	Global/Local	T.P.Neutral & T.P.Dependent		
specialFeatures	Global/Local	T.P.Neutral	Yes	Yes
specialItemCode	Global/Local	T.P.Neutral		
specialPermitOrExemptionIdentification	Global/Local	T.P.Neutral		
specialRequirementsDescription	Global/Local	T.P.Neutral	No	Yes
species	Global	T.P.Neutral		
speciesForFisheryStatisticsPurposesCode	Global/Local	T.P.Neutral		
speciesForFisheryStatisticsPurposesName	Global/Local	T.P.Neutral		
specificGravity	Global	T.P.Neutral		
specificGravityLowerValue	Global	T.P.Neutral		
specificGravityMeasurementPrecision	Global	T.P.Neutral		
specificGravityReferenceMaterialCode	Global	T.P.Neutral		
specificGravityUpperValue	Global	T.P.Neutral		
spongeScourerTypeCode	Global/Local	T.P.Neutral & T.P.Dependent		
sportCode	Global	T.P.Neutral	Yes	No
stackingFactor	Global	T.P.Neutral		
stackingFactorTypeCode	Global	T.P.Neutral		
stackingPatternTypeCode	Global/Local	T.P.Neutral & T.P.Dependent		
stackingWeightMaximum	Global/Local	T.P.Neutral	No	No
standardTypeHangerAgencyCode	Global/Local	T.P.Neutral		
startAvailabilityDateTime	Global/Local	T.P.Neutral & T.P.Dependent		
startDateMaximumBuyingQuantity	Global/Local	T.P.Neutral & T.P.Dependent		
startDateMinimumBuyingQuantity	Global/Local	T.P.Neutral & T.P.Dependent		
startDateTimeOfExclusivity	Global/Local	T.P.Neutral & T.P.Dependent		
staticContrastRatio	Global/Local	T.P.Neutral		
statisticalReportingMeasurement	Global/Local	T.P.Neutral	No	No
streetAddress	Global/Local	T.P.Neutral & T.P.Dependent		
streetNumber	Global/Local	T.P.Neutral & T.P.Dependent		
strongnessOfBasicTasteCode	Global/Local	T.P.Neutral		
storageCompatibilityAgency	Global/Local	T.P.Neutral		
storageCompatibilityCode	Global/Local	T.P.Neutral		
storageCompatibilityDescription	Global/Local	T.P.Neutral	No	Yes
storageRequirementsDescription	Global/Local	T.P.Neutral	No	Yes
storageStateCode	Global/Local	T.P.Neutral		
studioName	Global/Local	T.P.Neutral		
styleDescription	Global/Local	T.P.Neutral	No	Yes
subBrand	Global	T.P.Neutral		

Attribute Name	Target Market Applicability	Trading Partner Neutral status	Multiple Values (Grey = N/A)	Multi Language/ Measurement / Currency
subjectCode	Global/Local	T.P.Neutral		
subjectHeadingText	Global/Local	T.P.Neutral		
subjectSchemeIdentifierCode	Global/Local	T.P.Neutral		
subjectOfCertificationDescription	Global	T.P.Neutral	Yes	Yes
subjectSchemeName	Global/Local	T.P.Neutral		
subjectSchemeVersion	Global/Local	T.P.Neutral		
subTitle	Global/Local	T.P.Neutral		
subtitledLanguageCode	Global/Local	T.P.Neutral		
suffixToKey	Global/Local	T.P.Neutral		
suggestedConsumerPack	Global/Local	T.P.Neutral		
suggestedRetailPrice	Global/Local	T.P.Neutral	No	No
sunProtectionFactor	Global/Local	T.P.Neutral		
supplierSpecifiedMinimumConsumerStorage Days	Global/Local	T.P.Neutral		
supportedHDMIFeatureCode	Global/Local	T.P.Neutral		
surfaceOfCheeseAtEndOfRipeningCode	Global/Local	T.P.Neutral		
surroundSoundDigitalDecoderTypeCode	Global/Local	T.P.Neutral		
sustainabilityScore	Global/Local	T.P.Neutral & T.P.Dependent		
sustainabilityProgramCode	Global/Local	T.P.Neutral & T.P.Dependent		
sustainabilityValue	Global/Local	T.P.Neutral & T.P.Dependent		
sweaterPulloverTypeCode	Global/Local	T.P.Neutral		
sweetnessLevelOfAlcoholicBeverageCode	Global/Local	T.P.Neutral		
systemOrProcedurePackMedicalPurposeDescription	Global/Local	T.P.Neutral	Yes	Yes
systemOrProcedurePackTypeCode	Global/Local	T.P.Neutral & T.P.Dependent		
systemRequirementsQualifierCode	Global/Local	T.P.Neutral		
tablewareTypeCode	Global/Local	T.P.Neutral	Yes	No
targetAudience	Global/Local	T.P.Neutral	No	Yes
targetConsumerAge	Local	T.P.Neutral	No	Yes
targetConsumerAgeGroup	Global/Local	T.P.Neutral	Yes	Yes
targetConsumerAgeGroupCode	Global/Local	T.P.Neutral		
targetConsumerGender	Local	T.P.Neutral		
targetConsumerMaximumUsage	Global/Local	T.P.Neutral	No	No
targetConsumerMinimumUsage	Global/Local	T.P.Neutral	No	No
targetConsumerUsageTypecode	Global/Local	T.P.Neutral		
targetedConsumptionBy	Global/Local	T.P.Neutral		
targetMarketCountryCode	Global	T.P.Neutral		
targetMarketSubdivisionCode	Global	T.P.Neutral		
targetMarketConsumerSalesConditionCode	Global/Local	T.P.Neutral		
targetOccasionOrTheme	Global/Local	T.P.Neutral	Yes	Yes
targetSurfaceTypeCode	Global/Local	T.P.Neutral & T.P.Dependent	Yes	No
tastingNotes	Global/Local	T.P.Neutral	No	Yes
technicalChemicalName	Global/Local	T.P.Neutral		
televisionInformationServiceTypeCode	Global/Local	T.P.Neutral		
televisionTextMemoryPageQuantity	Global/Local	T.P.Neutral		
temperatureTypeQualifierCode	Global/Local	T.P.Neutral		
tensileStrength	Global/Local	T.P.Neutral	No	Yes

Attribute Name	Target Market Applicability	Trading Partner Neutral status	Multiple Values (Grey = N/A)	Multi Language/ Measurement / Currency
terpeneSourceCode	Global/Local	T.P.Neutral & T.P.Dependent		
terpeneTypeCode	Global/Local	T.P.Neutral & T.P.Dependent		
testCriteriaDescription	Global/Local	T.P.Neutral	No	Yes
testSpeciesCode	Global/Local	T.P.Neutral		
testSpeciesDescription	Global/Local	T.P.Neutral	No	Yes
textAuthor	Global/Local	T.P.Neutral		
threadDenier	Global/Local	T.P.Neutral	No	No
threadTypeCode	Global/Local	T.P.Neutral		
titleElementLevel	Global/Local	T.P.Neutral		
titlePrefixType	Global/Local	T.P.Neutral		
titleRatingCodeReference	Global/Local	T.P.Neutral		
titleText	Global/Local	T.P.Neutral	No	Yes
titlesAfterNames	Global/Local	T.P.Neutral		
titlesBeforeNames	Global/Local	T.P.Neutral		
titleText	Global/Local	T.P.Neutral		
titleTypeCode	Global/Local	T.P.Neutral		
titleWithoutPrefix	Global/Local	T.P.Neutral		
toeStyleTypeCode	Global/Local	T.P.Neutral		
toLanguage	Global/Local	T.P.Neutral		
totalAudioPowerOutput	Global/Local	T.P.Neutral	No	Yes
totalCreditableIngredientTypeAmount	Global/Local	T.P.Neutral	No	Yes
totalNumberOfComponents	Global/Local	T.P.Neutral		
totalPackagingEconomicCostAmount	Global/Local	T.P.Neutral	No	Yes
totalPackagingEconomicCostAmountBasis	Global/Local	T.P.Neutral	No	No
totalPackagingEconomicCostMeasurementCode	Global/Local	T.P.Neutral		
totalPackagingEconomicCostMeasurementDescription	Global/Local	T.P.Neutral	No	Yes
totalPackagingRecoveryRate	Global/Local	T.P.Neutral		
totalPortionWeightAsPurchased	Global/Local	T.P.Neutral	No	Yes
totalQuantityOfNextLowerLevelTradeItem	Global	T.P.Neutral		
totalRecyclableContentPercentage	Global/Local	T.P.Neutral		
totalScreenArea	Global/Local	T.P.Neutral	No	Yes
totalVegetableSubgroupAmount	Global/Local	T.P.Neutral	No	Yes
towelTypeCode	Global/Local	T.P.Neutral	Yes	No
toxicityMeasurement	Global/Local	T.P.Neutral	No	No
toxicityMeasurementProtocolCode	Global/Local	T.P.Neutral		
toxicityMeasurementProtocolDescription	Global/Local	T.P.Neutral	No	Yes
toxicityReferenceSubstanceCode	Global/Local	T.P.Neutral		
toxicityReferenceSubstanceDescription	Global/Local	T.P.Neutral	No	Yes
toxicologicalInformationDescription	Global/Local	T.P.Neutral	No	Yes
trackNumber	Global/Local	T.P.Neutral		
trackTime	Global/Local	T.P.Neutral		
trackTitle	Global/Local	T.P.Neutral	No	Yes
tradeItemCompositionDepth	Global	T.P.Neutral	No	No
tradeItemCompositionWidth	Global	T.P.Neutral	No	No
tradeItemConditionCode	Global/Local	T.P.Neutral		
tradeItemDateOnPackagingFormatName	Global/Local	T.P.Neutral		
tradeItemDateOnPackagingFormatTypeCode	Global/Local	T.P.Neutral		



Attribute Name	Target Market Applicability	Trading Partner Neutral status	Multiple Values (Grey = N/A)	Multi Language/ Measurement / Currency
tradeItemDateOnPackagingLocation	Global/Local	T.P.Neutral		
tradeItemDateOnPackagingTypeCode	Global/Local	T.P.Neutral		
tradeItemDescription	Global	T.P.Neutral & T.P.Dependent	Yes	Yes
tradeItemExclusiveSellingLocationCode	Global/Local	T.P.Neutral & T.P.Dependent		
tradeItemFeatureBenefit	Global	T.P.Neutral & T.P.Dependent	Yes	Yes
tradeItemFeatureCodeReference	Global	T.P.Neutral		
tradeItemFinishDescription	Global	T.P.Neutral	No	Yes
tradeItemFormCode	Global/Local	T.P.Neutral		
tradeItemFormDescription	Global	T.P.Neutral	Yes	Yes
tradeItemGenderTypeCode	Global	T.P.Neutral & T.P.Dependent		
tradeItemGroupIdentificationCodeReference	Global	T.P.Neutral		
tradeItemIdentificationMarkingTypeCode	Global/Local	T.P.Neutral		
tradeItemIdentificationMarkingValue	Global/Local	T.P.Neutral		
tradeItemIncludedAccessories	Global/Local	T.P.Neutral	No	Yes
tradeItemIntroductionYear	Global/Local	T.P.Neutral		
tradeItemKeyWords	Global/Local	T.P.Neutral & T.P.Dependent	Yes	Yes
tradeItemLicenseCharacter	Global/Local	T.P.Neutral	Yes	Yes
tradeItemLicenseEndDateTime	Global/Local	T.P.Neutral		
tradeItemLicenseOwnerGLN	Global/Local	T.P.Neutral		
tradeItemLicenseOwnerName	Global/Local	T.P.Neutral		
tradeItemLicenseRegion	Global/Local	T.P.Neutral		
tradeItemLicenseStartDateTime	Global/Local	T.P.Neutral		
tradeItemLicenseTitle	Global/Local	T.P.Neutral	No	Yes
tradeItemMarketingMessage	Global/Local	T.P.Neutral & T.P.Dependent	Yes	Yes
tradeItemMarkingsDescription	Global/Local	T.P.Neutral	Yes	Yes
tradeItemMaterialDesignationCode	Global/Local	T.P.Neutral	No	No
tradeItemMaterialDesignationDescription	Global/Local	T.P.Neutral	No	Yes
tradeItemOperatingEnvironment	Global/Local	T.P.Neutral		
tradeItemPrice	Global/Local	T.P.Neutral & T.P.Dependent	No	No
tradeItemPriceTypeCode	Global/Local	T.P.Neutral & T.P.Dependent		
tradeItemStory	Global/Local	T.P.Neutral & T.P.Dependent	Yes	Yes
tradeItemSustainabilityFeatureCode	Global/Local	T.P.Neutral		
tradeItemSustainabilityStatement	Global/Local	T.P.Neutral	No	Yes
tradeItemTechnologyDescription	Global/Local	T.P.Neutral	Yes	Yes
tradeItemTemperatureConditionTypeCode	Global/Local	T.P.Neutral		
tradeItemTradeChannelCode	Global/Local	T.P.Neutral & T.P.Dependent		
tradeItemUnitDescriptorCode	Global	T.P.Neutral		
tradeItemUVRating	Global/Local	T.P.Neutral		
tradeItemVariantStatement	Global/Local	T.P.Neutral	No	Yes
tradeItemVariantGroupCode	Global/Local	T.P.Neutral & T.P.Dependent		
tradeItemVariantTypeCode	Global	T.P.Neutral		
tradeItemVariantValue	Global	T.P.Neutral	No	Yes
transportationMaximumQuantity	Global/Local	T.P.Neutral	No	No
transportationModeCode	Global/Local	T.P.Neutral		

Attribute Name	Target Market Applicability	Trading Partner Neutral status	Multiple Values (Grey = N/A)	Multi Language/ Measurement / Currency
transportationModeRegulatoryAgency	Global/Local	T.P.Neutral		
tunerTypeCode	Global/Local	T.P.Neutral		
typeOfCleaningCode	Global/Local	T.P.Neutral		
typeOfCleaningDisinfectionProcessCode	Global	T.P.Neutral		
typeOfDisinfectionCode	Global	T.P.Neutral		
typeOfBasicTasteCode	Global/Local	T.P.Neutral		
typeOfProductChangesAfterDateCode	Global/Local	T.P.Neutral		
typeOfWasteCode	Global	T.P.Neutral		
udidDeviceCount	Global/Local	T.P.Neutral		
udidFirstPublicationDateTime	Global/Local	T.P.Neutral & T.P.Dependent		
uDIProductionIdentifierTypeCode	Global/Local	T.P.Neutral & T.P.Dependent		
uniformResourceIdentifier	Global/Local	T.P.Neutral		
unitedNationsDangerousGoodsNumber	Global	T.P.Neutral		
unitsPerTradeItem	Global/Local	T.P.Neutral	No	Yes
unnamedPersons	Global/Local	T.P.Neutral		
upperExplosiveLimit	Global	T.P.Neutral		
upperExplosiveLimit	Global	T.P.Neutral		
usableProductVolume	Global	T.P.Neutral	No	No
usageColourDescription	Global	T.P.Neutral	Yes	Yes
usageDuringBreastFeedingCode	Global/Local	T.P.Neutral & T.P.Dependent		
usageDuringPregnancyCode	Global/Local	T.P.Neutral & T.P.Dependent		
vapeDeviceTypeCode	Global/Local	T.P.Neutral		
vapingKitCompatibilityCode	Global/Local	T.P.Neutral & T.P.Dependent		
variableTradeItemTypeCode	Global/Local	T.P.Neutral		
variableWeightAllowableDeviationPercentage	Global/Local	T.P.Neutral		
variableWeightRangeMaximum	Global/Local	T.P.Neutral	No	No
variableWeightRangeMinimum	Global/Local	T.P.Neutral	No	No
variantDescription	Global	T.P.Neutral	Yes	Yes
vegetableSubgroupCode	Global/Local	T.P.Neutral		
velocity	Global/Local	T.P.Neutral	No	Yes
verticalCameraAngleCode	Global/Local	T.P.Neutral		
verticalViewingAngle	Global/Local	T.P.Neutral		
vESAWallMountTypeCode	Global/Local	T.P.Neutral		
vintage	Global	T.P.Neutral		
vintner	Global	T.P.Neutral		
visibleLight	Global/Local	T.P.Neutral	No	Yes
visualMediaColourCode	Global/Local	T.P.Neutral		
volatileOrganicCompound	Global	T.P.Neutral	No	No
volatileOrganicCompoundBasis	Global	T.P.Neutral	No	No
volatileOrganicCompoundPercent	Global	T.P.Neutral		
volatileOrganicCompoundPercentMeasurementPrecision	Global	T.P.Neutral		
waistbandTypeCode	Global	T.P.Neutral	Yes	No
waistRiseCode	Global	T.P.Neutral		
warningCopyDescription	Global/Local	T.P.Neutral	Yes	Yes
warningsOrContraIndicationDescription	Global/Local	T.P.Neutral & T.P.Dependent	Yes	Yes
warrantyConstraint	Global/Local	T.P.Neutral		

Attribute Name	Target Market Applicability	Trading Partner Neutral status	Multiple Values (Grey = N/A)	Multi Language/ Measurement / Currency
warrantyDescription	Global/Local	T.P.Neutral	No	Yes
warrantyDuration	Global/Local	T.P.Neutral	No	No
warrantyEffectiveDateType	Global/Local	T.P.Neutral		
warrantyType	Global/Local	T.P.Neutral		
wasteAmount	Global/Local	T.P.Neutral	Yes	Yes
watchCaseShapeCode	Global	T.P.Neutral		
globalwasteDirectiveApplianceType	Global/Local	T.P.Neutral		
wasteDirectiveName	Global/Local	T.P.Neutral		
wasteDirectiveRegistrationNumber	Global/Local	T.P.Neutral		
waterHazardCode	Global/Local	T.P.Neutral		
waterSolubilityTypeCode	Global/Local	T.P.Neutral		
width (AdditionalTradeItemDimensions)	Global/Local	T.P.Neutral & T.P.Dependent	No	Yes
width (NonGTINLogisticsUnitInformation)	Global/Local	T.P.Neutral & T.P.Dependent	No	No
width (TradeItemMeasurements)	Global/Local	T.P.Neutral	No	No
workingPressureRatingClassCode	Global/Local	T.P.Neutral		
workingPressureRatingMaximum	Global/Local	T.P.Neutral	No	Yes
workingPressureRatingMinimum	Global/Local	T.P.Neutral	No	Yes
yearOfAnnual	Global/Local	T.P.Neutral		
yearOfProduction	Global/Local	T.P.Neutral		
yieldServingsPerUnit	Global/Local	T.P.Neutral		
zoomTimesFactor	Global/Local	T.P.Neutral		
zoomTypeCode	Global/Local	T.P.Neutral		

7.2 Divergence of section 7.1 (Class or Module variation) for TPN/TPD

The following modules or class defined below are divergence of section 7.1. The attributes in this module or class are not TPN but TPN/TPD.

Module	Class	Path Location
referencedFileDetailInformation Module	ReferenceFileHeader	Any attributes of the ReferenceFileHeader class in this path location are divergence from section 7.1 table. The attributes diverging are not TPN but TPN/TPD: <i>/catalogue_item_notification:catalogueItemNotification/transaction/documentCommand/catalogue_item_notification:catalogueItemNotification/catalogueItem/tradeItem/tradeItemInformation/extension/*[namespace-uri()='urn:gs1:gdsn:referenced_file_detail_information:xsd:3' and local-name()='referencedFileDetailInformationModule']/referencedFileHeader</i>

7.3 Measurement Rules (Music and Film Publishing Industries)

CubiScan[®] 30

The music and film publishing industries have a long history of utilizing a specific measurement orientation for CDs and DVDs. The method of measurement and orientation of these trade items has been incorporated into a measurement tool manufactured by Quantronix, Inc. The tool is called CubiScan[®] 30. This tool has emerged as a standard for these industries and is consistent with the National Association of Recording Merchandisers (NARM) method of measurement.

In this measurement system, the dimensional measurements of CDs and DVDs are derived as follows:

The trade item is laid flat in the upper left corner of the CubiScan[®] 30, with the spine along the left edge of the CubiScan[®] 30, and the front of the CD or DVD facing up.

NARM Height = Thickness

NARM Length = Bottom left to bottom right

NARM Width = Top left to bottom left

The information providers are expected to populate the appropriate EAN.UCC dimensional attributes per the chart below. Standard measurements for CDs and DVDs:

CubiScan [®] 30	GS1	CD	DVD
NARM Height	Depth	.25 in	.375 in
NARM Width	Height	4.75 in	5.375 in
NARM Length	Width	5.50 in	7.000 in

The illustrations below show how the product is oriented and measured:

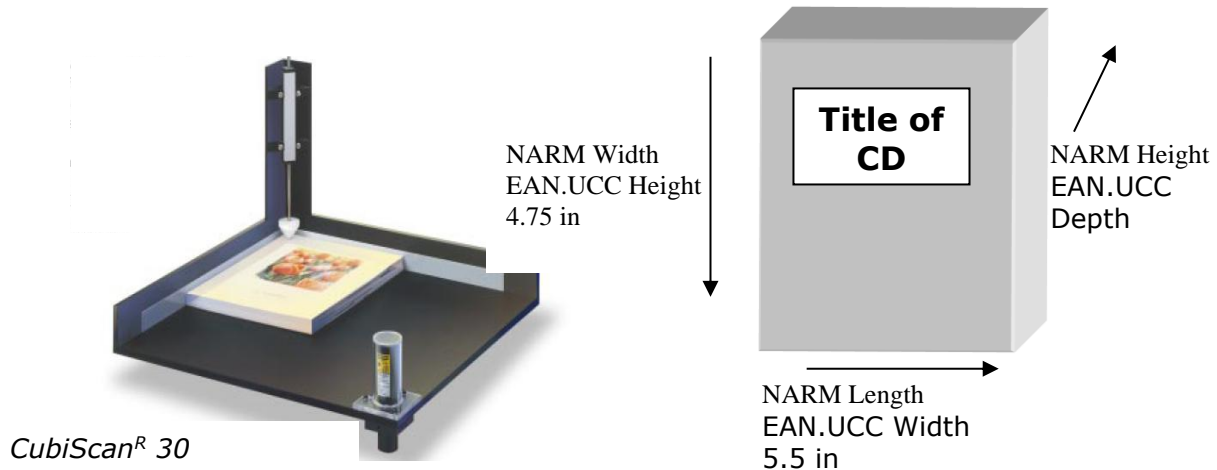

Peg Hole Measurements

Please use the following method for populating peg hole information for those trade items for which the packaging has more than one peg hole (this example is for a package with two peg holes):

Attribute	Value
Peg Hole Number	1
Peg Horizontal and UOM	1 in
Peg Vertical and UOM	2 in
Peg Hole Number	2
Peg Horizontal and UOM	4 in
Peg Vertical and UOM	2 in

Horizontal measurement is from left edge to the centre of the hole

Vertical measurement is from the top to the centre of the hole

Note: While the GS1 standard was revised to identify that a package may have more than one peg hole, at this time it incorrectly prohibits multiple iterations of these attributes. A request has been submitted to Align Data to consider an errata revision to correct this in the published standard.

7.4 GTIN Allocation Rules for Ingredient and Allergen Information

Breaking down ingredient information and allergy statements

Not all suppliers are currently able to break down the ingredient declaration or the allergy statement. That is why ingredients can also be specified in the 'ingredientStatement' attribute and allergen statement in the 'allergenStatement' attribute.

The ingredient (and allergen) split however is needed:

To enable structured searches

To enable specification of related information per ingredient, such as the content percentage and country of origin.

Production variant, GTIN allocation rules and minor ingredient changes

The GTIN Allocation rules state (<http://www.gs1.org/gtinrules/>) that:

The following changes warrant the allocation of a new GTIN:

1. Formulation change where the consumer is expected to distinguish the new from the old product and order accordingly.

2. Where regulations or other requirements dictate the ability to distinguish the old formulation from the new, e.g. healthcare
3. Where the changes alter the fundamental consumer benefit, e.g. new flavour, aroma, etc
4. Changes that result in a different description (declaration to the consumer)

The following changes do not warrant the allocation of a new GTIN:

5. Minor formulation or characteristic changes that will replace the existing trade item and does not involve any change in the declaration to the consumer (e.g. is not covered by legislation). Examples include: changes for cost reduction reasons without changing the trade item characteristics (e.g. taste, viscosity, minor ingredients change, etc.); changes to the button colour used on fashion items, etc
6. Changes to ingredients as a result of seasonal variations, e.g. yoghurt with seasonal fruit, where the actual fruits within are dependent on the season

The theory of changing a GTIN for every change in product formulation is sound and logical. However it must be remembered that changing a GTIN also requires a change to packaging with subsequent design/packaging and write off consequences. Many formulation changes might not actually require a change to packaging design other than to change the barcode. For instance one might change the technical specification of an ingredient such that the product might now exceed or fail a current allergen claim. This would require a change to a products declaration through GDS but not to packaging. A manufacturer will need to decide whether such a change warrants a change to GTIN with its subsequent costs.

The buyer of a particular product will also need to be able to manage changes of GTINs through their systems carefully. Buyers (in a GDS sense) rightly or wrongly do not like changes to GTINS and tend to treat them all as new listings with subsequent costs and the hassles of introducing the product and changing many systems to accommodate.

The best practice is to use the best before date of a product to distinguish between different variants of the same product. If manufacturers get calls from consumers about allergens etc and manufacturers know that they have multiple variants then they have to ask the consumer to tell the best before date on the consumer unit as well as the GTIN.

7.5 Deleted Attributes

The following attributes have been deleted in a Large GDSN Release, for completed information on deleted attributes please use the release delta document.

Attribute	Module	Definition	Sunset release number	Work Request
packagingMarkedDietAllergenCode	HealthWellnessPackagingMarking Module	Planned for deprecation, please follow migration plan as defined in Migration document for Global Data Model. Indication of which dietary or allergen marks that are on the package.	3.1.19	WR-19-000080
healthClaimCode	HealthRelatedInformationModule	Planned for deprecation, please follow migration plan as defined in Migration document for Global Data Model. Any health claims according to regulations of the target market.	3.1.23	WR - 19-000079 – WR - 19-000164
packagingMarkedFreeFromCode	HealthWellnessPackagingMarkingModule	Planned for deprecation, please follow migration plan as defined in Migration document for Global Data Model. Indication on the trade item that the package is marked free from something as specified by a code value.	3.1.23	WR - 19-000079 – WR - 19-000164

Attribute	Module	Definition	Sunset release number	Work Request
healthClaimDescription	HealthRelatedInformationModule	Planned for deprecation, please use nutritionalClaim. A description of any health claims according to regulations of the target market.	3.1.23	WR - 19-000079 - WR - 19-000164
cannabisCBDTypeCode	HealthRelatedInformationModule **Still exists in ProductInformationModule	Note: This attribute is being moved to ProductInformationModule/.../CannabisInformation class in a future release. A code that describes the type of Cannabidiol (CBD) which is one of many active compounds found in the Cannabis plant.	3.1.31	WR-23-000087

8 Appendices

8.1 Understanding Data Type Class Diagrams

To reduce nesting in XML Schemas, all code and compound data types (e.g. description, measurement, amount) in 3.x are designed to inherit the value for the data type (e.g Amount Value, Description Text). In other words, the class diagrams do not specifically identify the value as a distinct attribute as before.

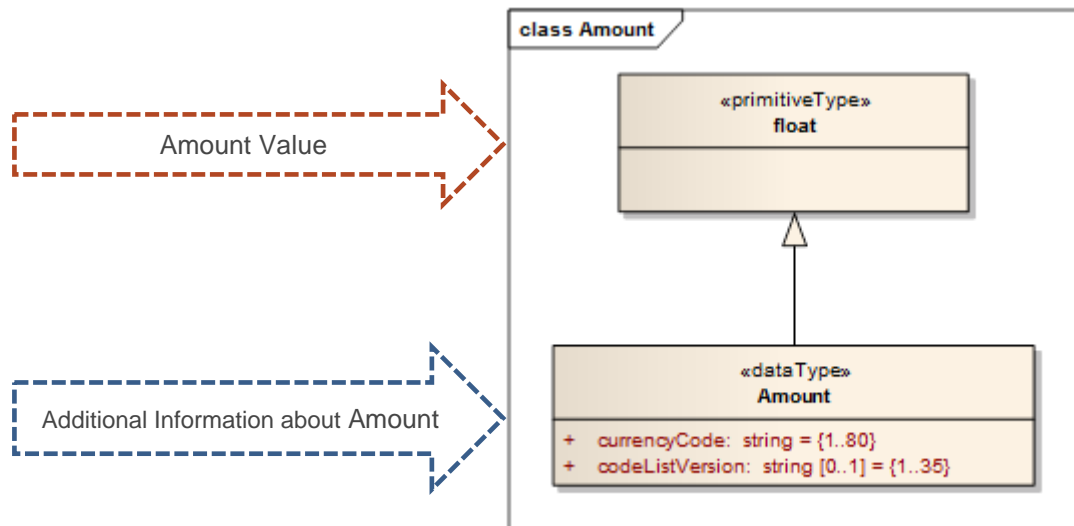

In XML representation, an amount would look like this:

```
<dutyFeeTaxBasisAmount currencyCode="EUR">500</dutyFeeTaxBasisAmount>
```

In the example, 500 represents the value for the dutyFeeTaxBasisAmount.

8.2 Usage Disclaimer for The Unified Code for Units of Measure (UCUM)

“This product includes all or a portion of the UCUM table, UCUM codes, and UCUM definitions or is derived from it, subject to a license from Regenstrief Institute, Inc. and The UCUM Organization. Your use of the UCUM table, UCUM codes, UCUM definitions also is subject to this license, a copy of which is available at <http://unisofmeasure.org>. The current complete UCUM table, UCUM Specification are available for download at <http://unitsofmeasure.org>. The UCUM table and UCUM codes are copyright © 1995-2013, Regenstrief Institute, Inc. and the Unified Codes for Units of Measures (UCUM) Organization. All rights reserved.

THE UCUM TABLE (IN ALL FORMATS), UCUM DEFINITIONS, AND SPECIFICATION ARE PROVIDED "AS IS." ANY EXPRESS OR IMPLIED WARRANTIES ARE DISCLAIMED, INCLUDING, BUT NOT LIMITED TO, THE IMPLIED WARRANTIES OF MERCHANTABILITY AND FITNESS FOR A PARTICULAR PURPOSE.”

9 Summary of Changes

Change	BMS Doc Version	Associated CR Number
<ul style="list-style-type: none"> • ApparelInformationModule: <ul style="list-style-type: none"> ○ Updated definition of StyleDescription. ○ Added closureOrFastenerTypeCode, closureOrFastenerLocation, and sizeTermDescription. • AudioVisualMediaContentInformationModule: Added softwareCategoryTypeDescription • AudienceOrPlayerInformationModule: Added experienceLevel. • ConsumerInstructionsModule: Added recommendedUsageLocation • DutyFeeTaxInformationModule: Added dutyFeeTaxBasisPrice, dutyFeeTaxCountrySubdivisionShipFromCode, dutyFeeTaxCountrySubdivisionShipToCode, dutyFeeTaxLegalProvision • ElectronicDeviceCharacteristicsInformationModule: Added maximumResolution, resolutionTypeCode, microphoneTypeCode, includedOperatingSystem, connectorFinishDescription • FoodAndBeverageIngredientInformation: Updated definition for ingredientSequence • FoodAndBeveragePreparationServingModule: Updated definition for manufacturerPreparationTypeCode • HealthRelatedInformationModule: Added in definition for isTradeItemChemicalNotIntendedForHumanConsumption • MarketingInformationModule: Added campaignMediaTypeDescription, designer, educationalFocusDescription, targetOccasionOrTheme, targetConsumerAgeGroup • NonfoodIngredientModule: <ul style="list-style-type: none"> ○ Added isNonfoodIngredientEmphasized, nonfoodIngredientDefinition, nonfoodIngredientPurpose ○ Updated definition for ingredientStrength. • NonGTINLogisticsUnitInformationModule <ul style="list-style-type: none"> ○ NonGTINLogisticsUnitInformation/depth: Updated definition. ○ NonGTINLogisticsUnitInformation/width: Updated definition. ○ NonGTINLogisticsUnitInformation/height: Updated definition. • NutritionalInformationModule: Added nutrientAdditionalInformationDescription and nutrientFormatTypeCodeReference. • ONIXPublicationFileInformationModule: <ul style="list-style-type: none"> ○ Added onixPartNumber, Created class ONIXSupplyDetail and attribute onixProductAvailabilityCode. ○ Updated definitions for epubUsageStatus, epubUsageType and unnamedPersons to specify code list. ○ Updated definition to unNamedPersons to specify code list. • PackagingInformationModule <ul style="list-style-type: none"> ○ PackagingDimension/packagingDepth: Updated definition. 	<p>3.1.2</p>	<p>12-241 12-242 12-243 12-289 13-019 14-146 14-189 15-003 15-015 15-017 15-024 15-121 15-122 15-194 15-220 15-222 15-240 15-248 15-257 15-298 15-304 15-312 15-322 15-323 15-325 15-328 15-330 15-349 15-354 16-005 16-123 16-135 16-185 16-186 16-149</p>

<ul style="list-style-type: none"> ○ PackagingDimension/packagingHeight: Updated definition. ○ PackagingDimension/packagingWidth: Updated definition. ○ PackagingLevel: Updated definition ○ Added isPackagingReturnable • PackagingSustainabilityModule <ul style="list-style-type: none"> ○ Deleted redundant association to Packaging Recovery in GDD report. • PlaceOfProductActivityModule: <ul style="list-style-type: none"> ○ countryOfOriginStatement: Updated definition. ○ productActivityRegionZoneCodeReference: Updated definition. • ReferencedFileDetailInformationModule: Added additionalCameraAngleCode, fileCameraPerspectiveCode, verticalCameraAngleCode • RegulatedTradeItemModule: Added isPackagingMarkedWithRegulatoryCompliance • SalesInformationModule: <ul style="list-style-type: none"> ○ Added isPermitOrLicenseRequiredToSell. ○ Changed definition for • SafetyDataSheetModule: Updated definition of chemicalIngredientConcentration. • SustainabilityModule <ul style="list-style-type: none"> ○ physicalResourceUsage: Updated definition. ○ runModeCode: Updated definition. • TextileMaterialModule: Added tradeItemMaterialDesignationDescription • TradeItem <ul style="list-style-type: none"> ○ ChildTradeItem: Clarified that the generalization to TradeItemIdentification brings the GTIN into the class in the schema. ○ tradeItemUnitDescriptorCode: Updated definition. ○ AdditionalTradeItemDimensions/depth: Updated definition. ○ AdditionalTradeItemDimensions/width: Updated definition. ○ AdditionalTradeItemDimensions/height: Updated definition. ○ Updated definitions for numberOfPiecesInSet, totalNumberOfComponents • TradeItemDataCarrierAndIdentificationModule <ul style="list-style-type: none"> ○ gs1TradeItemIdentificationKeyCode: Updated definition • TradeItemLifespanModule: Added itemMinimumDurability. • TradeItemMeasurementsModule <ul style="list-style-type: none"> ○ TradeItemMeasurements/depth: Updated definition. ○ TradeItemMeasurements/width: Updated definition. ○ TradeItemMeasurements/height: Updated definition. • TransportationHazardousClassificationModule: <ul style="list-style-type: none"> ○ shippingRegulationException: Updated definition. ○ specialRequirementsDescription: Updated definition. 		
---	--	--

<ul style="list-style-type: none"> • Section 7.1: <ul style="list-style-type: none"> ◦ tradeItemFormDescription: Removed details on repeatable language since it is a string value. ◦ tradeItemPrice: Changed to single value to match model. ◦ foodBeverageCompositionDescription: removed values for value and language repeatability. • Added TradeItemLicensingModule (New Module) • Added AnimalFeedingModule (New Module) • VideoDisplayDeviceInformationModule: Added displayPanelBacklightType • Removed section 7.2 since it is also in the implementation guide. • Updated definition of growingMethodCode. 		
<ul style="list-style-type: none"> • Changed section 7.1 to label the attribute “designer” as repeatable for language. • Fixed model for AnimalFeedingModule to change references of 3.2 to 3.1.2. • Fixed table of contents. 	3.1.2	Errata
<ul style="list-style-type: none"> • AdditionalCameraAngleCode data type and GDD report: added note to use FileCameraPerspective Code List. • Section 7.1, specified that onixPartNumber is repeatable for language only. • NutrientFormatTypeCodeReference, corrected GDD report for cardinality. • Corrected definition of animalNutrientMaximumPercent 	3.1.2	Errata (1.1.5)
<ul style="list-style-type: none"> • nutrientBasisQuantity: Updated definition. • servingSize: Updated definition. • packagingTypeDescription: Updated definition. • additionalTradeItemIdentification: Changed attribute to Trading Partner Neutral and Tradeing Partner Dependent. 	3.1.2.1	(1.1.6) 16-184 16-262 16-325
<ul style="list-style-type: none"> • Moved NonpackagedSizeDimension class to GDSN Common. • Moved Textile Material Class to GDSN Common • AlcoholInformationModule: <ul style="list-style-type: none"> ◦ Added vintage ◦ Added alcoholProof • Allergen Related Information Module: <ul style="list-style-type: none"> ◦ Added allergenRelevantDataProvidedDateTime ◦ Added isAllergenRelevantDataProvided • AnimalFeedingModule: <ul style="list-style-type: none"> ◦ Added feedType ◦ Added targetedConsumptionBy • ApparelInformationModule: <ul style="list-style-type: none"> ◦ styleDescription: Changed Cardinality to 0..* to handle multiple languages. ◦ collarType: Changed Cardinality to 0..* to handle multiple languages. ◦ sleeveType: Changed Cardinality to 0..* to handle multiple languages. ◦ descriptiveSizeDimension: Changed Cardinality to 0..* to handle multiple languages. • AudienceOrPlayerInformationModule: <ul style="list-style-type: none"> ◦ ageRangeDescription: Made repeatable for language ◦ targetAudience: Made repeatable for language • AudioVisualMediaContentInformationModule: <ul style="list-style-type: none"> ◦ trackTitle: Made repeatable for language • AudioVisualMediaProductDescriptionInformationModule: <ul style="list-style-type: none"> ◦ payPerViewWindow: Data type change from integer to nonnegativeInteger ◦ editionDescription: Made repeatable for language ◦ longSynopsis: Made repeatable for language ◦ shortSynopsis: Made repeatable for language 	3.1.3	

<ul style="list-style-type: none"> • Award Prize Module: <ul style="list-style-type: none"> ◦ awardPrizeDescription: Changed Cardinality to 0..* to handle multiple languages. • BatteryInformationModule: <ul style="list-style-type: none"> ◦ Added maximumBatteryLife ◦ Added batteryTypeQualifierCode ◦ Added TextileMaterial ◦ Added batteryWattHourRating ◦ Added powerSupplyTypeCode • ChemicalRegulationInformationModule: <ul style="list-style-type: none"> ◦ Added isChemicalRegulationCompliant • ConsumerInstructionsModule: <ul style="list-style-type: none"> ◦ Added consumerUsageLabelCode ◦ Added consumerAssemblyInstructions • DairyFishMeatPoultryItemModule: <ul style="list-style-type: none"> ◦ cheeseMaturationPeriodDescription: Made repeatable for language ◦ Added catchMethodCode ◦ Added productionMethodForFishAndSeafoodCode ◦ Added dateOfCatchProcessTypeCode ◦ Added storageStateCode ◦ Added speciesForFisheryStatisticsPurposesCode ◦ Added speciesForFisheryStatisticsPurposesName • DangerousSubstanceInformationModule: Added dangerousSubstanceHazardSymbolCodeReference • Delivery Purchasing Information Module: <ul style="list-style-type: none"> ◦ orderQuantityMultiple: Integer to nonnegativeInteger ◦ orderQuantityMinimum: Integer to nonnegativeInteger ◦ orderQuantityMultiple: Integer to nonnegativeInteger ◦ Added consumerFirstDeliveryDate ◦ Added consumerEndAvailabilityDateTime • DurableGoodsCharacteristicsModule: <ul style="list-style-type: none"> ◦ tradeItemFinishDescription Made repeatable for language ◦ Added numberOfWheels ◦ Added mountLocationDescription ◦ Added mountTypeDescription • DutyFeeTaxInformationModule: <ul style="list-style-type: none"> ◦ dutyFeeTaxAgencyCode: Made Optional ◦ dutyFeeTaxTypeDescription: Made repeatable for language ◦ dutyFeeTaxReductionCriteriaDescription: Made repeatable for language • ElectronicDeviceCharacteristicsInformationModule: <ul style="list-style-type: none"> ◦ Added maximumAvailableStorageCapacity ◦ requiredSystemMemoryCapacity: Data type change ◦ requiredStorageCapacity: Data type change from integer to nonnegativeInteger ◦ totalAudioPowerOutput: Data type change from integer to nonnegativeInteger • FarmingProcessingInformation <ul style="list-style-type: none"> ◦ Added postHarvestTreatmentCode ◦ Added postProcessTradeItemTreatmentPhysicalCode • FoodAndBeverageIngredientModule: <ul style="list-style-type: none"> ◦ Added ingredientContentPercentageMeasurementPrecision Code ◦ Added ingredientDefinition ◦ Added isIngredientEmphasised • FoodAndBeveragePreparationServingModule: 		
---	--	--

<ul style="list-style-type: none"> ○ maximumNumberOfSmallestUnitsPerPackage: Changed Data type change from integer to nonnegativeInteger ○ numberOfSmallestUnitsPerPackage Data type change from integer to nonnegativeInteger ○ Added numberOfServingsRangeDescription • FoodAndBeveragePropertiesModule: <ul style="list-style-type: none"> ○ microbiologicalOrganismMaximumValue: Changed definition ○ physiochemicalCharacteristicValue Data type change from Measurement to Quantity ○ microbiologicalOrganismMaximumValue ○ microbiologicalOrganismReferenceValue: Made repeatable for Measurement ○ microbiologicalOrganismWarningValue: Made Repeatable for Measurement ○ Added microbiologicalOrganismMaximumValueBasis ○ Added microbiologicalOrganismMaximumValuePrecisionCode ○ Added microbiologicalOrganismReferenceValueBasis ○ Added microbiologicalOrganismReferenceValuePrecisionCode ○ Added microbiologicalOrganismWarningValueBasis ○ Added microbiologicalOrganismWarningValuePrecisionCode ○ Added physiochemicalCharacteristicValueBasis ○ Added physiochemicalCharacteristicValuePrecisionCode ○ Added physiochemicalCharacteristicReferenceValue ○ Added physiochemicalCharacteristicReferenceValueBasis ○ Added physiochemicalCharacteristicReferenceValuePrecisionCode ○ Added physiochemicalCharacteristicWarningValue ○ Added physiochemicalCharacteristicWarningValueBasis ○ Added physiochemicalCharacteristicWarningValuePrecisionCode • GDSN Common <ul style="list-style-type: none"> ○ Added organicClaimCertification ○ enumerationValueDefinitionMade 0..* from 1..* ○ enumerationValueDescription: Changed Cardinality to 0..* to handle multiple languages. ○ Added Description4000 ○ hazardousMaterialAdditionalInformation; Changed cardinality to 0..*. ○ Added isPrimaryFile ○ contentDescription: Changed Cardinality to 0..* ○ fileFormatDescription: Changed Cardinality to 0..* to handle multiple languages. ○ Added FormattedDescription250es. ○ Added FormattedDescription4000 ○ Added FormattedDescription5000 • ChildNutritionInformationModule: New module • HealthRelatedInformationModule: <ul style="list-style-type: none"> ○ Added nutritionalProgramDetail ○ Added sunProtectionFactor 		
--	--	--

<ul style="list-style-type: none"> ○ Added tradeItemUVRating • HealthWellnessPackagingMarkingModule: <ul style="list-style-type: none"> ○ Added packagingMarkedNutritionLabelCode ○ Added isPackagingLabelledWithDrugFacts ○ packagingMarkedFreeFromCode: Definition change. • LightingDeviceModule: New module • MarketingInformationModule: <ul style="list-style-type: none"> ○ Added channelSpecificMarketingMessage ○ Added marketingTradeChannel ○ Added channelSpecificShortMarketingMessage ○ campaignName: Changed Cardinality to 0..* to handle multiple languages. ○ couponFamilyCode: Changed Cardinality to 0..* to handle multiple languages. ○ tradeItemMarketingMessage: Changed Cardinality to 0..* to handle multiple languages. ○ tradeItemIncludedAccessories: Changed Cardinality to 0..* to handle multiple languages. ○ targetConsumerAge: Changed Cardinality to 0..* to handle multiple languages. ○ Added shortTradeItemMarketingMessage ○ tradeItemMarketingMessage: Changed data Type to FormattedDescription4000 ○ Added tradeItemKeyWords ○ Added necessaryTradeItemToUseDescription ○ Added tradeItemTechnologyDescription • MedicalDeviceTradeItemModule: <ul style="list-style-type: none"> ○ Added isTradeItemExemptFromDirectPartMarking ○ Added uDIDDeviceCount • NonfoodIngredientModule: <ul style="list-style-type: none"> ○ Added nonfoodIngredientOfConcernCode ○ Added nonFoodIngredientStatement • NutritionalInformationModule: <ul style="list-style-type: none"> ○ Added nutrientValueDerivationCode ○ Added dailyValueIntakeReference ○ servingSize: Made repeatable for multiMeasurement ○ Added descriptionOnANutrient ○ Added isNutrientRelevantDataProvided ○ Added nutrientRelevantDataProvidedDateTime • ONIXPublicationFileInformationModule: <ul style="list-style-type: none"> ○ AdditionalPublicationDescription: Made repeatable for language ○ biographicalNote: Made repeatable for language ○ contributorDescription: Made repeatable for language ○ illustrationNote: Made repeatable for language ○ audienceDescription: Made repeatable for language ○ editionStatement: Made repeatable for language ○ contributorStatement: Made repeatable for language • PackagingInformationModule: <ul style="list-style-type: none"> ○ Added packagingMaterialClassificationCodeReference ○ Added packagingMaterialColourCodeReference ○ Added packagingRefundObligationName ○ Added PackagingDividerInformation ○ Added numberOfDividersHorizontal ○ Added numberOfDividersVertical ○ Added placementOfDivider ○ Added shippingContainerTypeCode ○ Added packagingMaterialClassificationCodeReference ○ Added packagingMaterialColourCodeReference • PackagingMarkingModule: 		
--	--	--

<ul style="list-style-type: none"> ○ Added consumerWarningTypeCode ○ Added consumerWarningDescription ○ Added tradeItemIdentificationMarkingTypeCode ○ Added localPackagingMarkedLabelAccreditationCodeReference ○ Added ConsumerWarningInformation ○ Added tradeItemMarkingsDescription • PackagingSustainabilityModule: <ul style="list-style-type: none"> ○ acidificationMeasurement: Data type change from Measurement to Quantity ○ aquaticEutrophicationMeasurement: Data type change from Measurement to Quantity ○ aquaticEutrophicationModelDescription: Made repeatable for language ○ cumulativeEnergyDemand: Data type change from Measurement to Quantity ○ freshWaterEcotoxicityMeasurement: Data type change from Measurement to Quantity ○ globalWarmingPotentialEquivalent: Data type change from Measurement to Quantity ○ massEquivalentMeasurement: Data type change from Measurement to Quantity ○ quantityOfFunctionalBasisUnit: Data type change from Measurement to Quantity ○ packagingWeightPerConsumerUse: Made repeatable for multiMeasurement • PharmaceuticalItemInformationModule: <ul style="list-style-type: none"> ○ Added dosageRecommendation ○ Added dosageFormType ○ Added drugSideEffectsAndWarnings ○ Added drugInteractions ○ Added drugPreparations • PhysicalResourceUsageInformationModule: <ul style="list-style-type: none"> ○ Changed class definition. ○ physicalResourceUsage: Changed definition. ○ physicalResourceUsageMeasurementTypeCode: Changed definition. ○ physicalResourceUsage: Changed definition. • ProductFormulationModule: New module • ReferencedFileDetailInformationModule: <ul style="list-style-type: none"> ○ fileResolutionDescription: Made repeatable for language • RegulatedTradeItemModule: <ul style="list-style-type: none"> ○ Added regulatoryActComplianceLevelCode ○ Added isTradeItemRegulatoryCompliant • SafetyDataSheetInformationModule: <ul style="list-style-type: none"> ○ Added lowerExplosiveLimit ○ Added upperExplosiveLimit ○ Added chemicalIngredientConcentrationLowerValue ○ Added chemicalIngredientConcentrationMeasurementPrecision ○ Added chemicalIngredientConcentrationUpperValue ○ Added flashPointDescriptor ○ Added flashPointTemperatureLowerValue ○ Added flashPointTemperatureUpperValue ○ Added flashPointTemperatureMeasurementPrecision ○ Added flashPointTemperature ○ Added lethalConcentration50MeasurementPrecision ○ Added lethalDose50MeasurementPrecision ○ physicalFormDescription: Made repeatable for language 		
--	--	--

<ul style="list-style-type: none"> ○ Added volatileOrganicCompoundPercentMeasurementPrecision ○ firstAidProceduresDescription: Data type change from Description1000 to Description5000 ○ Added: isProductClassifiedAsNonHazardous ○ Added specificGravityLowerValue ○ Added specificGravityMeasurementPrecision ○ Added specificGravityUpperValue • SalesInformationModule: <ul style="list-style-type: none"> ○ Added TargetMarketSalesConditions ○ Added TargetMarketDiscountRestrictions ○ Added cutForSaleThicknessCode ○ Added minimumOrderValue ○ Added isDiscountingIllegal ○ Added SalesInformation ○ Added consumerSalesConditionCode ○ Added SalesInformation • TextileMaterialModule: <ul style="list-style-type: none"> ○ materialContent: Made repeatable for language ○ materialThreadCount: Made repeatable for language ○ Added materialCountryOfOrigin ○ Added materialTreatment • Trade Item <ul style="list-style-type: none"> ○ additionalTradeItemClassificationPropertyDescription: Made repeatable for language ○ propertyMeasurement: Made repeatable for measurement ○ propertyDescriptionMade: repeatable for language ○ Added componentQuantity ○ Added componentMultiplePackedQuantity ○ Added GDSNTradeItemClassificationAttribute ○ Added productInformationLegalDisclaimer ○ Added isTradeItemReinstated ○ nonMarkedTradeItemComponents: Made repeatable for language ○ contentsDescription: Made repeatable for language ○ Added multipleContainerQuantity ○ availableTime: Made repeatable for language ○ Added productionVariantCancelledDateTime ○ Added productionVariantDiscontinuedDateTime ○ productionVariantDescription: Made repeatable for language ○ Added udidFirstPublicationDate • TradeItemDescriptionModule: <ul style="list-style-type: none"> ○ tradeItemVariantValue: Changed Data Type to Description70. ○ Added tradeItemFormCode ○ Added isTradeItemDesignedToBeDivisible ○ regulatedProductName: Made repeatable for language • TradeItemHumidityInformationModule: <ul style="list-style-type: none"> ○ cumulativeHumidityInterruptionAcceptableTimeSpanInstructions: Repeatable for language and values • TradeItemMeasurementsModule: <ul style="list-style-type: none"> ○ Added netContentStatement ○ Added NonpackagedSizeDimension 		
<ul style="list-style-type: none"> • AlcoholInformationModule <ul style="list-style-type: none"> ○ Added alcoholicBeverageSugarContent • AnimalFeedingModule <ul style="list-style-type: none"> ○ Added example code to targetedConsumptionBy attribute since definition was unclear. • BatteryInformationModule 	<p>3.1.3 Comment Review. Version 1.1.5</p>	

<ul style="list-style-type: none"> <ul style="list-style-type: none"> ○ Changed association from BatteryDetail to TextileMaterial to new class TradeItemMaterial (located in GDSN Common). • Child Nutrition Information Module <ul style="list-style-type: none"> ○ Deleted attribute childNutritionApprovalDateTime ○ Deleted attribute childNutritionProductIdentificationAgencyCode ○ Updated definition for childNutritionExpirationDateTime ○ Updated definition for childNutritionProductIdentification. ○ Updated definition for childNutritionQualifierCode ○ Updated definition for childNutritionQualifiedValue ○ Updated definition for childNutritionValue • DairyFishMeatPoultryInformation <ul style="list-style-type: none"> ○ Moved isImitationOrSubstitute to MarketingInformation. ○ Added catchDateTime ○ Changed length of speciesForFisheryStatisticsPurposesCode to 1..80. ○ dateOfCatchProcessTypeCode • ElectronicDeviceTechnicalCharacteristicsModule <ul style="list-style-type: none"> ○ Added maximumAvailableStorageCapacity to GDD Report. • HealthRelatedInformationModule <ul style="list-style-type: none"> ○ Made tradeItemUVRating 0..1 • MedicalDeviceTradeItemModule <ul style="list-style-type: none"> ○ Changed uDIDDeviceCount to udidDeviceCount. • NutritionalInformationModule <ul style="list-style-type: none"> ○ Updated GDD Report to make dailyValueIntakeReference a Description500. • OrganicClaim <ul style="list-style-type: none"> ○ Deleted the reference to CertificationInformation ○ Added and association to AVPList to handle Certification Requirement. • PackagingInformationModule <ul style="list-style-type: none"> ○ Added ShippingContainerTypeCode to GDD Report • PackagingMarkingModule <ul style="list-style-type: none"> ○ Changed data type for localPackagingMarkedLabelAccreditationCodeReference to string {1..200}. ○ Changed consumerWarningTypeCode to 0..1 ○ Changed definition of consumerWarningDescription to refer to correct attributes. • PhysicalResourceUsageInformationModule <ul style="list-style-type: none"> ○ Updated definition for PhysicalResourceUsage and PhysicalResourceUsageModule class. • ProductFormulationStatementModule <ul style="list-style-type: none"> ○ Changed attribute name,totalVegetableAmount, to totalVegetableSubgroupAmount. ○ Changed definition for creditableIngredientDescription. ○ Changed nonCreditableGrainAmount and nonCreditableGrainDescription to noncreditableGrainAmount and noncreditableGrainDescription • PromotionalItemInformationModule <ul style="list-style-type: none"> ○ Added isTradeItemAPromotionalUnit • GDSN Common <ul style="list-style-type: none"> ○ Removed TextileMaterial from GDSN Common. Moved it back to the TextileMaterialModule. ○ Created a new class TradeItemMaterial and TradeItemMaterialComposition. ○ Updated definition of productActivityTypeCode. 		
--	--	--

<ul style="list-style-type: none"> ○ Updated the definition for countryOfOrigin to reference ISO country code. ○ Changed definition of attributeCode to reflect MLT as and example (Rec 20 code). • SafetyDataSheetInformationModule <ul style="list-style-type: none"> ○ Updated definition for flashPointTemperature. • SalesInformationModule <ul style="list-style-type: none"> ○ In TargetMarketDiscountRestrictions <ul style="list-style-type: none"> ▪ Changed isDiscountingIllegal to isDiscountingIllegalInTargetMarket and made it mandatory. ▪ Changed name of link from TargetMarketDiscountRestrictions to Country to discountRestrictionTargetMarketCountry and made it mandatory ○ In TargetMarketConsumerSalesConditions <ul style="list-style-type: none"> ▪ Changed consumerSalesConditionCode to targetMarketConsumerSalesConditionCode ▪ Changed name of link from TargetMarketSalesConditions to Country to salesConditionTargetMarketCountry and made it mandatory. • TextileMaterialModule <ul style="list-style-type: none"> ○ Moved TextileMaterial and TextileMaterialComposition back into TextileMaterialModulePackage. • TradeItem <ul style="list-style-type: none"> ○ Changed attribute name of udidFirstPublicationDate to udidFirstPublicationDateTime. ○ Changed componentQuantity to 0..1 ○ Added notes to contentsDescription and nonMarkedTradeItemComponents to not use these attributes as they will be deleted in a future release. ○ Added examples in definitions for componentMultiplePackedQuantity and multipleContainerQuantity. • TradeItemLifespanModule <ul style="list-style-type: none"> ○ Added itemPeriodSafeToUseAfterOpening • Section 7.1 <ul style="list-style-type: none"> ○ Made consumerEndAvailabilityDateTime, consumerFirstAvailabilityDateTime, consumerFirstDeliveryDate TPD. ○ Changed minimumOrderValue to TPN and TPD. ○ Changed udidFirstPublicationDateTime to Trading Partner Dependent. 		
<ul style="list-style-type: none"> • Trade Item <ul style="list-style-type: none"> ○ Updated definitions for componentMultiplePackedQuantity and multipleContainerQuantity ○ Updated definition for countryOfOrigin to reflect subdivision. ○ Fixed definition for PhysicalResourceUsage. ○ Added definition for exhibitGroup. • Section 7.1 <ul style="list-style-type: none"> ○ tradeItemMarketingMessage changed to allow repetition for value and language. ○ Added proofOfPackagingWeightReductionDescription ○ Changed udidFirstPublicationDateTime to T.P.Neutral & T.P.Dependent. ○ Added creditableGrainGroupCode ○ Added exhibitGroup 	1.1.6	

<ul style="list-style-type: none"> ○ Made lowerExplosiveLimit global ○ Deleted organicClaimCertification ○ Made consumerEndAvailabilityDateTime, consumerFirstAvailabilityDateTime, consumerFirstDeliveryDate TPN and TPD. 		
<ul style="list-style-type: none"> • AudioVisualMediaContentInformationModule <ul style="list-style-type: none"> ○ Added numberOfEpisodes to AudioVisualMediaContentInformation Class • AudioVisualMediaProductDescriptionInformationModule <ul style="list-style-type: none"> ○ Added audioVisualMediaCollectionSeriesNumber to AudioVisualMediaProductDescription Class • ConsumerInstructionsModule <ul style="list-style-type: none"> ○ Added dexterityUsageCode to ConsumerInstructions Class • ElectronicDeviceCharacteristicsInformationModule <ul style="list-style-type: none"> ○ Added equalizerControlFeatures to TradeItemAudioInformation Class • FoodAndBeverageIngredientModule <ul style="list-style-type: none"> ○ Added isIngredientRelevantDataProvided to FoodAndBeverageIngredientModule Class • LightingDeviceModule <ul style="list-style-type: none"> ○ Added lightBulbShapeCode to LightBulbInformation Class ○ Added lightBulbBaseType to LightBulbInformation Class ○ Added lightBulbDiameterValue to LightBulbInformation Class ○ Added lightBulbFilamentTypeCode to LightBulbInformation Class ○ Added lightOutput to LightingDeviceModule Class • MarketingInformationModule <ul style="list-style-type: none"> ○ Added autographedBy to MarketingInformation Class ○ Added isTradeItemConsideredCollectibleOrMemorabilia to MarketingInformation Class ○ Added usageColourDescription to MarketingInformation Class ○ Added tradeItemIntroductionYear to MarketingInformation Class • NonGTINLogisticsInformationModule <ul style="list-style-type: none"> ○ Added logisticsUnitCubeDimension to NonGTINLogisticsUnitInformation Class ○ Added netWeight To NonGTINLogisticsUnitInformation Class • PackagingInformationModule <ul style="list-style-type: none"> ○ Added packagingSustainabilityStatement to PackagingInformationModule Class • OpticsDeviceInformationModule <ul style="list-style-type: none"> ○ Added zoomTimesFactor to ZoomInformation Class ○ Added zoomTypeCode to ZoomInformation Class ○ Added lensTypeDescription to LensInformation Class ○ Added lensCoatingTypeDescription to LensInformation Class ○ Added lensFilterTypeDescription to LensInformation Class ○ Added exposureMode to OpticsDeviceInformation Class ○ Added fieldOfView to OpticsDeviceInformation Class • RegulatedTradeItemModule <ul style="list-style-type: none"> ○ Added regulationRestrictionsAndDescriptors to RegulatoryInformation Class 	<p>1.1.7</p>	<p>Release 3.1.4</p>

<ul style="list-style-type: none"> ○ Added regulationRestrictionCommunityIdentifier to RegulatoryInformation Class ○ Added regulationCommunityLevelCode toRegulatoryInformation Class • TradeItemHandlingModule <ul style="list-style-type: none"> ○ Added stackingPatternTypeCode to TradeItemStacking Class • TradeItemMeasurementsModule <ul style="list-style-type: none"> ○ Added tensileStrength to TradeItemMeasurements class 		
<ul style="list-style-type: none"> • Moved selfTimerDelay from OpticsDeviceInformation to ElectronicDeviceCharacteristicsInformationModule. • Changed isTradeItemConsideredCollectibleOrMemorabilia to Global/Local • Changed isIngredientRelevantDataProvided to Global/Local • Changed definition of OpticsDeviceInformationModule to reflect all optics devices not just photography. • Changed definition of association to OpticsDeviceInformation to reflect all optics devices not just photography. • NonGTINLogisticsInformationModule: made logisticsUnitCubeDimension and netWeight 0..1 to match other instances of attributes. 	1.1.8	Release 3.1.4 Comment Review
<ul style="list-style-type: none"> • Added additiveTypeCodeReference to AdditiveInformation class. • Added velocity to TradeItemMeasurements class. • Added nutrientBasisQuantityDescription to NutrientHeader. • Added OrganicCertification class to OrganicClaim. Added organicCertificationIdentification, organicCertificationEffectiveEndDateTime, organicCertificationEffectiveStartDateTime. • Added organicClaimAgencyTypeCode to OrganicClaim. • Added TransactionalMeasurementUnitCode to GDSN Common Data Types. • Added TransactionalMeasurement to GDSN Compound Data Types • Added shippingContainerQuantity to Packaging class. • Updated definition of batteryTypeCode. • lastChangeDateTime: changed to Global/Local in section 7.1 • additionalPartyIdentification: added value in section 7.1, made Global/Local and TPN/TPD. • tradeItemWeight/netWeight: updated definition to remove business rules. • Updated definitions for packagingDepth, packagingHeight, packagingWidth • Updated definition for batteryTypeCode. • Updated the definition for nutrientBasisQuantity, servingSize. 	3.1.5	16-000444 17-000017 17-000023 15-000002 16-000529 17-000020 16-000520 16-000465 16-000352 17-000061 17-000188
<ul style="list-style-type: none"> • Changed additionalTradeItemClassificationCodeDescription, additionalTradeItemClassificationCodeValue, additionalTradeItemClassificationPropertyCode, additionalTradeItemClassificationPropertyDescription, additionalTradeItemClassificationSystemCode, additionalTradeItemClassificationVersion,propertyAmount, propertyCode, propertyDateTime, propertyDescription, propertyFloat, propertyString, propertyInteger, propertyMeasurement to Global/Local in In Section 7.1. • Added isOrphanDrug to PharmaceuticalItemInformation. 	3.1.5	Community Review 16-000536
<ul style="list-style-type: none"> • TradeItemInformation: <ul style="list-style-type: none"> ○ Updated definitions for productionVariantDescription, productionVariantEffectiveDateTime, productionVariantCancelledDateTime 	3.1.6	

<ul style="list-style-type: none"> ○ Added productionVariantDiscontinuedDateTime, consumerProductVariantEndEffectiveDateTime, consumerProductVariantIdentification, consumerProductVariantReasonCode • AnimalFeedingModule: Added feedAnalyticalConstituentsStatement, feedAdditiveStatement, feedCompositionStatement, feedingInstructions • MarketingInformation: <ul style="list-style-type: none"> ○ Added TradeItemCaseInformation Class and added new attribute caseDescription. ○ Added brandMarketingDescription • NutrientHeader: Added servingsPerPackageDescription • TradeItemMeasurements: added acceleration, frontFaceTypeCode, shearStrength • Changed productionVariantCancelledDateTime, productionVariantDescription, productionVariantDiscontinuedDateTime, productionVariantEffectiveDateTime to TPN/TPD. 		
<ul style="list-style-type: none"> • AnimalFeedingModule: Updated definition for feedType • FoodAndBeverageIngredientModule: Added additiveStatement to FoodAndBeverageIngredientModule • FoodAndBeveragePreparationServingModule: Added recipe to PreparationServing • GDSNCommon: Added grossWeight to AdditionalTradeItemDimensions • HealthcareItemInformationModule: Added healthcareItemMaximumUsageAge, healthcareItemMinimumUsageAge, healthcareItemUsageAgeDescription, usageDuringBreastFeedingCode, usageDuringPregnancyCode to healthcareItemInformation. • LightingDeviceModule: Added colourTemperature and visibleLight to LightBulbInformation. • MarketingInformationModule: Added tastingNotes to MarketingInformation • NonfoodIngredientModule: Added additiveStatement to NonfoodIngredientModule • NutritionalInformationModule: Added nutrientSource to NutrientDetail • PackagingMarkingModule: Added consumerFriendlyDateOnPackagingDescription to PackagingDate • Section 7.1: Added details for following attributes: <ul style="list-style-type: none"> ○ additiveStatement, recipe, grossWeight (AdditionalTradeItemDimensions), healthcareItemMaximumUsageAge, healthcareItemMinimumUsageAge, healthcareItemUsageAgeDescription, usageDuringBreastFeedingCode, usageDuringPregnancyCode, colourTemperature, visibleLight, tastingNotes, additiveStatement, nutrientSource, consumerFriendlyDateOnPackagingDescription ○ Updated following for Global/Local and TPN/TPD Status <ul style="list-style-type: none"> ▪ quantityOfLayersPerPallet ▪ quantityOfTradeItemsPerPallet ▪ quantityOfTradeItemsPerPalletLayer ▪ depth (NonGTINLogisticsUnitInformation) ▪ height (NonGTINLogisticsUnitInformation) ▪ width (NonGTINLogisticsUnitInformation) ▪ grossWeight (NonGTINLogisticsUnitInformation) ▪ logisticsUnitCubeDimension 	<p>3.1.7</p>	

<ul style="list-style-type: none"> ▪ netWeight (NonGTINLogisticsUnitInformation) ▪ stackingPatternTypeCode 		
<ul style="list-style-type: none"> • Section 7.1 <ul style="list-style-type: none"> ○ Added consumerFriendlyDateOnPackagingDescription is Single Value, Multi-description ○ Made logisticsUnitStackingFactor TPN/TPD ○ height (nonGTINLogisticsUnitInformation) made TPN/TPD ○ depth (nonGTINLogisticsUnitInformation) made TPN/TPD ○ width, depth, height (AdditionalTradeItemDimensions) made TPN/TPD. ○ netWeight (nonGTINLogisticsUnitInformation) made single value/single measurement since it is 0..1. • FoodAndBeverageIngredientModule <ul style="list-style-type: none"> ○ Changed AdditiveStatement to Description5000 • NonfoodIngredientModule <ul style="list-style-type: none"> ○ Changed AdditiveStatement to Description5000 • NutritionalInformationModule <ul style="list-style-type: none"> ○ Added descriptionOnNutrientQualifier • PreparationServing <ul style="list-style-type: none"> ○ Changed recipe to Description5000 • AlcoholInformationModule <ul style="list-style-type: none"> ○ Added isTradeItemAQualityVintageAlcoholProduct • RegulatedTradeItemModule <ul style="list-style-type: none"> ○ Added doesTradeItemContainElectricalComponents • TradeItemDisposalInformationModule <ul style="list-style-type: none"> ○ Added sparePartsAvailabilityEffectiveDateTypeCode ○ Added sparePartsAvailabilityPeriod • AdditionalTradeItemDimensions <ul style="list-style-type: none"> ○ Made grossWeight 0..1 	3.1.7	Com Rev
<ul style="list-style-type: none"> • Updated definition for frontFaceTypeCode to reference DEPTH not LENGTH • Reverted quantityOfTradeItemsContainedInACompleteLayer to Global and TPN. 	Errata 3.1.7	
<p>ChemicalRegulationInformationModule</p> <ul style="list-style-type: none"> • regulatedChemicalName, changed length to 1000. • technicalChemicalName, changed length to 1000. <p>ConsumerInstructionsModule</p> <ul style="list-style-type: none"> • consumerStorageInstructions, changed data type to Description5000 • consumerUsageInstructions, Changed data type to Description5000 <p>GDSNCommon</p> <ul style="list-style-type: none"> • Added Language Optional Description Data Types • classOfDangerousGoods, Updated Definition • Added dangerousGoodsLimitedQuantityIndexHazardousInformationDetail • dangerousGoodsPackingGroup, Updated Datatype to Code • dangerousGoodsShippingName, Changed Datatype to LanguageOptionalDescription1000 • Added dangerousGoodsSubsidiaryClass to HazardousInformationDetail • dangerousGoodsTechnicalName, Changed data type to Description1000 • aDRDangerousGoodsLimitedQuantitiesCode, Updated Definition • aDRDangerousGoodsPackagingTypeCode, Updated Definition • Added dangerousGoodsLimitedQuantitiesCode to HazardousInformationHeader 	3.1.8	

<ul style="list-style-type: none"> • Added dangerousGoodsPackagingTypeCode to HazardousInformationHeader • Added association from PartyInRole to StructuredAddress • Added city to StructuredAddress • Added countryCode to StructuredAddress • Added postalCode to StructuredAddress • Added provinceStateCode to StructuredAddress • Added streetAddress to StructuredAddress • Added association from TradeItemContactInformation to StructuredAddress • Added materialThreadCount to TradeItemMaterialComposition <p>HealthcareItemInformationModule</p> <ul style="list-style-type: none"> • Added doesTradeItemContainHumanTissue to HealthcareItemInformation • Added healthcareGroupedProductCode to HealthcareItemInformation • Added isTradeItemExemptFromSerialisation to HealthcareItemInformation <p>HealthRelatedInformation</p> <ul style="list-style-type: none"> • Added compulsoryAdditionalLabelInformation HealthRelatedInformation • compulsoryAdditiveLabelInformation, Updated Definition <p>MarketingInformationModule</p> <ul style="list-style-type: none"> • tradeItemFeatureBenefit, Changed data type to FormattedDescription250 <p>MedicalDeviceTradeItemModule</p> <ul style="list-style-type: none"> • Added clinicalSizeDescription to ClinicalSize • Added clinicalSizeTypeCode to ClinicalSize • Added clinicalSizeValue to ClinicalSize • Added association from MedicalDeviceInformation to ClinicalSize • Added isExemptFromPremarketAuthorisation to MedicalDeviceInformation • Added directPartMarkingIdentifier to MedicalDeviceInformation <p>NutritionalInformationModule</p> <ul style="list-style-type: none"> • servingSizeDescription, Changed data type to Description500 <p>PackagingInformationModule</p> <ul style="list-style-type: none"> • Added industrySpecificPackagingTypeCodeReference to Packaging <p>PackagingMarkingModule</p> <ul style="list-style-type: none"> • consumerPackageDisclaimer, Changed data type to Description5000 • ConsumerWarningDescription, Changed data type to Description5000 • warningCopyDescription, Changed data type to Description5000 <p>SalesInformationModule</p> <ul style="list-style-type: none"> • allowanceChargeDescription, Changed data type to Description500 • Added netDueTimePeriod to ApplicablePaymentTerms • Added paymentDueBasisTypeCode to ApplicablePaymentTerms • Added discountApplicablePeriod to AvailableDiscount • Added discountBaseTypeCode to AvailableDiscount • targetMarketSalesConditionCode, Made optional in UML <p>TextileMaterialModule</p> <ul style="list-style-type: none"> • Deleted association from TextileMaterialModule to TextileMaterial • Added association from TextileMaterialModule to TradeItemMaterial <p>TradeItemDescriptionInformationModule</p>		
---	--	--

<ul style="list-style-type: none"> tradeItemFormDescription, Changed data type from String of 35 to languageOptionalDescription500 variantDescription, Changed data type to Description500 Added econtentEnvironmentTypeCode to TradeItemEContent Added econtentTradeItemStatement to TradeItemEContent Added association from TradeItemDescriptionInformation to TradeItemEContent <p>TradeItemTemperatureInformation</p> <ul style="list-style-type: none"> Added maximumEnvironmentAtmosphericPressure Added minimumEnvironmentAtmosphericPressure <p>TransportationHazardousClassificationModule</p> <ul style="list-style-type: none"> marinePollutantTechnicalName, Changed length to 1000. reportableQuantityTechnicalName, Changed length to 1000. 		
<ul style="list-style-type: none"> Removed materialThreadCount from TradeItemMaterialComposition in GDSN Common (backed out from initial 3.1.8 design) Reverted TextileMaterialModule to 3.1.3 design. Changed provinceStateCode to length of 1..80 to match Shared Common attribute Changed data type of directPartMarkingIdentifier to identifier. Removed compulsoryAdditionalLabelInformation from HealthRelatedInformation. This change will not be part of this release. Added clinicallyRelevantCharacteristicOfMedicalDevice and clinicalWarningCode to HealthcareItemInformation. Moved the class ClinicalSize from MedicalDevice to HealthcareItemInformation. PackagingMarkingModule: <ul style="list-style-type: none"> Added new class (TradeItemIdentificationMarking) Added tradeItemIdentificationMarkingTypeCode and tradeItemIdentificationMarkingValue handlingInstructionsCodeReference: Changed definition and Section 6.2 to reference use of HandlingInstructionsCode_GDSN in GDD and Code List BMS. 	3.1.8	Community Review
<ul style="list-style-type: none"> Corrected sequence of nutrientTypeCode and preparationStateCode in model (no impact on schemas) HealthcareItemInformation <ul style="list-style-type: none"> Changed clinicalWarningCode from a code datatype to a new repeatable class containing ClinicalWarningAgencyCode and clinicalWarningCode. 	3.1.8	Eballot Comments
<ul style="list-style-type: none"> 4.1 Core Trade Item, GDD Report: Fixed typo from NextLowerLevelTradeItem to NextLowerLevelTradeItemInformation to be in line with UML model. 5.3 AnimalFeedingModule, GDD Report: Added missing association to avpList in GDD report to be in line with Model. 5.4 ApparelInformationModule, GDD Report: Fixed typo in class name from "ClosureFastnerInformation" to "ClosureFastenerInformation" + fixed typo in datatype from "ClosureOfFastenerTypeCode" to "ClosureOrFastenerTypeCode". 5.14 ConsumerInstructionsModule, GDD Report: Fixed content type for dexterityUsageCode from "association" to "attribute" to be in line with model. 5.15 Controlled Substance Module, GDD Report: added missing association from ControlledSubstanceInformation to avpList. 	3.1.9	Initial Draft

<ul style="list-style-type: none"> • 5.15 Controlled Substance Module, GDD Report: Removed erroneous association from ControlledSubstance to avpList. • 5.18 DangerousSubstanceInformationModule, GDD Report: Removed one instance of avpList association in DangerousSubstanceProperties Class (there were 2) to be in line with model. • 5.19 DeliveryPurchasingInformationModule, GDD Report: Added missing association from DeliveryPurchasingInformation to avpList to be in line with model. • 5.20 DietInformationModule, GDD Report: Added missing association from DietInformation to avpList. Removed in GDD report inexistent association from DietTypeInformation to avpList. • 5.23 ElectronicDeviceCharacteristicsInformationModule, GDD Report: Added to gdd report the missing association from ElectronicDeviceCharacteristicsInformationModule to ImageDeviceResolutionInformation. • 5.24 FarmingAndProcessingInformationModule, GDD Report: fixed typo in name of FarmingAndProcessingInformationModule from FarmingProcessingInformationModule. • 5.32 MarketingInformationModule, GDD Report: Added missing association from MarketingInformation to ChannelSpecificMarketingInformation. • 5.33 MedicalDeviceTradeItemModule, GDD Report: Fixed name of module from MedicalDeviceInformationModule to MedicalDeviceTradeItemModule + removed empty association from GDD Report for MedicalDeviceInformation. • 5.38 ONIXPublicationFileInformationModule, GDD Report: Added missing GDD report for class TitleElement • 5.43 PackagingSustainabilityModule, GDD Report: corrected content type for avpList from Attribute to Association in PackagingSustainabilityModule class + corrected in GDD report avpList from Attribute to Association in LifeCycleIndicators class + corrected in GDD report avpList from Attribute to Association in IndividualPackagingComponentLevel class + corrected in GDD report avpList from Attribute to Association in PackagingSustainabilityEconomicIndicators class. • 5.44 PharmaceuticalItemInformation, GDD Report: added missing association to Dosage in class PharmaceuticalItemInformation. • 5.45 PhysicalResourceUsageInformationModule, GDD Report: Added missing association from PhysicalResourceUsageInformation to avpList. • 5.55 SafetyDataSheetModule, GDD Report: Fixed typo in association from SafetyDataSheetInformation to ReferencedFileInformation (was ReferencedFileInformation). • 5.58 SoftwareSystemRequirementsModule, GDD Report: removed line for avpList in the module class it self and added missing avpList in SoftwareSystemsRequirements class. • 5.59 SustainabilityModule, GDD Report: Removed 2nd line for AVPList in SustainabilityInformation class to be in line with model. • 5.60 TextileMaterialModule, GDD Report: added missing association to avpList in TextileMaterialComposition class. • 5.63 TradeItemDisposalInformationModule, GDD Report: Added missing association to avpList in TradeItemDisposalInformationModule class and removed erroneous association to avpList in TradeItemDisposalInformation class. 		
---	--	--

<ul style="list-style-type: none"> • 5.69 TradeItemMeasurementsModule, GDD Report: Fixed the named association tradeItemNonPackagedSize to NonPackagedSizeDimension from the TradeItemMeasurements class to be in line with model (was unnamed association to tradeItemnonPackagedSize). • 3.14 HazardousInformationHeader, GDD Report: Removed double association from HazardousInformationDetail to avpList to single one to be in line with model. • 5.38 ONIXPublicationFileInformationModule: Added missing UML diagram for ONIXTitleElement class + fixed name of attribute from publicationDateTimeCode to publicationDateTypeCode + fixed datatype for the same attribute from ONIXPublicationType to ONIXPublicationTypeCode. • 5.14 ConsumerInstructionsModule, GDD Report and UML diagram: Added new attribute productUsageBodyLocationCode to class Consumer Instructions. + added missing content type "Association" to association from consumerInstructionsModule to class ConsumerInstructions + Added missing content type "Attribute" to consumerStorageInstructions, consumerUsageInstructions. Updated UML diagram for the codes with the new added ProductUsagebodyLocationCode datatype • 5.17 DairyFishMeatPoultryItemModule: Added new attribute catchAreaCode to class FishCatchInformation in both class diagram and gdd report. • 3.8 CertificationInformation: Added new attribute isCertificateRequired to both class diagram and GDD Report, • 5.19 DeliveryPurchasingInformationModule: Added startDateTimeOfExclusivity in GDD report and class diagrams. (DeliveryPurchasingInformation class) • 5.56 SalesInformationModule: Added new attribute tradeItemExclusiveSellingLocationCode (SalesInformation class) in GDD report and class diagrams. • 3.16 OrganicInformation: Added new attribute organicClaimAgencyName. (Both class diagram and gdd report + section 7.1) • 3.17 NonpackagedSizeDimension: Added new attribute isSizeTypeVariant (In class diagram, gdd report and section 7.1) • 5.32 MarketingInformationModule: Added new attribute targetConsumerAgeGroupCode to class TargetConsumer (in GDD, class diagram and section 7.1). Added missing content type "Attribute" to attribute caseDescription in GDD report. 		
<ul style="list-style-type: none"> • Added "Please use the CatchAreaCode_GDSN codelist." To the definition of catchAreacode. • Added a period at the end of definition of organicClaimAgencyName. • Backed out the following changes: <ul style="list-style-type: none"> ○ Added BMS Ids to the attributes, associations, classes and modules. ○ 5.4 ApparelInformationModule, added GDD report for NonPackagedSizedimension with unique BMS Ids. ○ 5.8 Audio Visual Media Production Information Module: Added GDD report for AspectRatioInformation with unique BMS Id ○ 5.10 Battery Information Module: Added GDD report for TradeItemMaterial and Country with unique BMSId 	3.1.9	Community Review

<ul style="list-style-type: none"> ○ 5.11 Certification Information Module: Added GDD Report for CertificationInformation and all associated classes with unique BMS Id ○ 5.12 chemical Regulation Information Module: Added GDD report for RegistrationInformation with unique BMS Id ○ 5.13 Child Nutrition Information Module: Added GDD Report for ReferencedFileInformation classes with unique BMS Id ○ 5.14 Consumer Instructions Module: Added GDD Report for ExternalCodeValueInformation with associated class including unique BMS Ids. ○ 5.16 Copyright Information Module: Added GDD report for PartyIdentification including BMS Ids. ○ 5.18 Dangerous Substance Information Module: Added GDD report for ExternalCodeValueInformation and DangerousHazardousLabel with unique BMS Ids. ○ 5.19: Delivery Purchasing Information Module: Added GDD report with unique BMS IDs for IncotermInformation ○ 5.20 Diet Information Module: Added GDD report for CertificationInformation and associated classes with unique BMS Ids. ○ 5.25 Food and Beverage Ingredient Module: Added GDD reports for AdditiveInformation, FarmingAndProcessingInformation, OrganicInformation, PartyInRole and PlaceOfProductActivity with unique BMS IDs ○ 5.60 Textile Material Module: In GDD Report, added missing association to avpList in TextileMaterialComposition class (bms id 3464) ○ 5.11 Certification Information Module: Added new attribute isCertificateRequired to both class diagram and GDD Report, ○ 5.20 Diet Information Module: Added new attribute isCertificateRequired to both class diagram and GDD Report, ○ 5.25 Food And Beverage Ingredient Module: Added new attribute organicClaimAgencyName. (Both class diagram and gdd report + section 7.1) (BMS Id 6156) ○ 5.24 Farming And Processing Information Module: Added new attribute organicClaimAgencyName. (Both class diagram and gdd report + section 7.1) (BMS Id 6155) ○ 5.69 Trade Item Measurements Module: Added new attribute isSizeTypeVariant (In class diagram, gdd report and section 7.1) (BMS ID 6158) ○ 5.4 Apparel Information Module: Added new attribute isSizeTypeVariant (In class diagram, gdd report and section 7.1) (BMS ID 6157) 		
<ul style="list-style-type: none"> • In table 7.1 made productUsageBodyLocationCode G/L from G based on comment Steve Robba. • Added missing attribute nutritionalScore to HealthRelatedInformation class + updated class diagram and GDD.+ Added to section 7.1. 	3.1.9	Community Review 2
<ul style="list-style-type: none"> • 5.17 Dairy Fish Meat Poultry Item Module: Updated FishReportingInformation UML diagram to reflect catchAreaCode datatype is catchAreaCode_GDSN. Also updated the code diagram to include catchAreaCode_GDSN. + Changed datatype in GDD report 	3.1.9	XML Developer comments

<ul style="list-style-type: none"> from CatchAreaCode to CatchAreaCode_GDSN + removed "Please use the CatchAreaCode_GDSN codelist." from definition. 5.56 Sales Information Module: Updated code uml diagram by adding TradeItemExclusiveSellingLocationCode. 		
<ul style="list-style-type: none"> 5.28 Health Related Information Module: Backed out nutritionalScore attribute from UML, GDD Report and section 7.1 as this attribute can only go in in a next release. 	3.1.9	eBallot comments
<ul style="list-style-type: none"> 5.28 Health Related Information Module: Reintroduced nutritionalScore attribute from UML, GDD Report and section 7.1 by agreement. 	3.1.9	eBallot Comments
<ul style="list-style-type: none"> 5.28 Health Related Information Module: Added constraint of {1..80} to nutritionalScore attribute for clarification purposes only. + Removed compulsoryAdditionalInformation attribute from UML as it was never in this nor any previous release. 	3.1.9	eBallot Comments 1.4.7
<ul style="list-style-type: none"> WR19-158: Fixed typo in 5.15 ControlledSubstanceModule: from ControlledSubstance/contolledSubstanceCode to ControlledSubstance/controlledSubstanceCode WR19-055: In 3.20 ReferencedFileInformation, added new attribute fileSequenceNumber. WR19-017: In 5.54 RegulatedTradeItemModule, added new attribute regulationLevelCodeReference in the RegulatedInformation Class. WR19-008: In 3.20 ReferencedFileInformation, added two new attributes: alternateText and titleText WR18-364 & 18-365: Added in 5.32 MarketingInformationModule added new class TargetConsumerUsage associated to TargetConsumer and added 3 new attributes: targetConsumerMinimumUsage, targetConsumerMaximumUsage, targetConsumerUsageTypecode to TargetConsumerUsage class. WR18-357: In 4.2 GDSNTradeItemClassification added new attribute additionalTradeItemClassificationCodeSequenceNumber WR 18-358: In 5.48 ProductCharacteristicsModule, added new attribute productCharacteristicSequenceNumber. WR 18-339: In 5.45 PhysicalResourceUsageInformationModule, added new attribute physicalResourceUsageRatingScaleCodeReference in class PhysicalResourceUsageTradeItemClassification WR 18-287: Added in 5.19 DeliveryPurchasingInformationModule, new attribute deliveryFrequencyCode in class DistributionDetails WR 19-045: Changed in 5.62 TradeItemDescriptionModule the definition of eContentTradeItemStatement & eContentEnvironmentTypeCode WR 19-112: In 5.42 PackagingMarkingModule, changed the definition of packagingMarkedLabelAccreditationCode. WR 19-051: Added in 4.1 Core Trade Item an association from Trade Item to a new class nonGTINReferencedItem with new attributes referencedTradeItemTypecode and additionalTradeItemIdentification. WR 18-323: In 5.32 MarketingInformationModule, updated attribute definition for specialItemCode in class MarketingInformation WR 18-275: in 5.32 MarketingInformationModule, class MarketingInformation, added new attribute tradeItemStory. 	3.1.10	Initial draft 1.4.8
<ul style="list-style-type: none"> (Section 5.28) Updated the Health Related Information Module UML diagram to represent nutritionalScore as optional. This is errata from 3.1.9 	3.1.10	XML Developer Comments

<ul style="list-style-type: none"> • WR 19-079: Changed in 5.37 Nutritional Information Module, changed definition of attribute nutritionalClaimNutrientElementCode • (Section 5.41) Updated the UML diagram of Packaging Information Module to revert back wrong inclusion of changes 		1.4.9
<ul style="list-style-type: none"> • Fixed typo double space in definition of nutritionalClaimNutrientElementCode. • Fixed typo double space in definition of physicalResourceUsageRatingScaleCodeReference • Section 7.1 Changed additionalTradeItemClassificationCodeSequenceNumber from TPN/TPD to TPN only and changed G to G/L • In Section 7.1, Changed the below from G to G/L alternateText deliveryFrequencyCode fileSequenceNumber titleText tradeItemStory • Corrected the font color for remnants of previous release for regulatedProductName in Section 7.1 	3.1.10	Community Review – 1.4.10
<ul style="list-style-type: none"> • Section 3.20 - changed fileSequenceNumber to single value from multiple values, Errata fix. Somehow this got changed to multivalued between versions. 	3.1.10	eBallot Comments 1.4.11
<ul style="list-style-type: none"> • WR-19-000118 Section 5.17 - Changed the definition of the attribute productionMethodForFishAndSeafoodCode. • WR-19-000150 Section 5.62 - Changed data type length of the attribute tradeItemVariantValue from Description70 to Description500 to match the data type length of variantDescription. • WR-19-000190 Section 5.75, 7.1 - New Attribute of data type Boolean added - isExtendedWarrantyFreeOfFees. • WR-19-000199 Section 5.28, 7.1 - new attribute is added - nutritionalValue and integrated into the module HealthRelatedInformationModule. • WR-19-000211, Section 7.1 - new attribute colourFamilyCode along with its code list is added to the colour class • WR-19-000224, Section 5.3, 7.1 - added 2 new attributes to the AnimalFeedingModule - animalFeedingDescriptionOnANutrient and animalFeedingDescriptionOnNutrientQualifier • WR-19-000243, Section 5.28, 7.1 - add new attribute with code list, cannabisCBDTypeCode in the HealthRelatedInformation module • WR-19-000251, Section 5.17, 7.1 - Add the new attribute "fatPercentageInDryMatterMeasurementPrecisionCode" using the measurementPrecisionCode Values. In the DairyFishMeatPoultryItem module to indicate measurement precision. • WR-19-000286, Section 5.28, 7.1 - add two new attributes - nutritionalProgramIngredientTypeCode : identifies the group of ingredients and nutritionalProgramIngredientMeasurement : Identifies its values and unit of measure • WR-19-000291, Section 5.75 - The proposed change is to have the attribute warrantyType repeatable by values. • Added data type FormattedDescription500 for WR18-000173, Section 3.1.1 • WR 18-000173 Section 5.62 - Changed data type of regulatedProductName from Description500 to FormattedDescription500 	3.1.12	Initial Draft 1.4.12

<ul style="list-style-type: none"> • WR 19-000399 Section 5.75 – Changed data type of WarrantyEffectiveDateType from string {1..70} to {1..80} 		
<ul style="list-style-type: none"> • Section 7.1 – updated isExtendWarrantyFreeOfFees to be Global/Local and TPN/TPD. • Section 7.1 – updated animalFeedingDescriptionOnANutrient and animalFeedingDescriptionOnNutrientQualifier to be Global/Local • Section 7.1 - updated nutritionalValue attribute to be Global/Local • Section 5.28, 7.1 – updated nutritionalProgramIngredientMeasurement attribute to be multi-measurement. • Section 5.75, 6.2 – updated code list names for warrantyEffectiveDateType and warrantyType. Also updated definitions in the WarrantyInformationModule 	3.1.12	Community Review Comments – 1.4.13
<ul style="list-style-type: none"> • WR 19-298 Textile Material Module: Section 5.60, 7.1 - Add a new attribute: materialStatement to TextileMaterialModule. Section 3.23 is also updated and materialStatement is added to TradeItemMaterial class also as this will be replacing TextileMaterial module in future. • WR 19-317 Section 7.1, Shared Common – add new attributes colourTintCode and patternCode • Definition change for ProvenanceStatement was deployed in release 3.1.10 but was missed specifying in Summary of changes and Delta for Attributes. Definition change was in red font color in BMS for 3.1.10, 3.1.11 and 3.1.12. Changing it to black font in this release. 		Initial Draft for 3.1.13 – 1.4.14
<ul style="list-style-type: none"> • Corrected the typo in the Summary of changes – corrected colorTintCode to colourTintCode • Removed empty paragraphs in Navigation 		Community Review Comments for 3.1.13 – 1.4.15
<ul style="list-style-type: none"> • WR 20-031 Section 5.55, Section 7.1: SafetyDataSheet module – Add new attribute sDSSheetVersion. • WR 20-032 Section 5.55, Section 7.1: SafetyDataSheet module – Add new attribute sDSSheetEffectiveDateTime. • WR 20-022 Section 5.71, Section 7.1: TradeItemTemperatureInformation module – Add new attribute labeledTemperature. • WR 19-351 Section 5.10, Section 7.1: BatteryInformationModule – Add new attributes batteryCapacity, batteryVoltage, isBatteryRechargeable, quantityOfBatteriesIncluded. • WR 19-378 Section 5.1, Section 7.1: AlcoholInformationModule – Add new attribute alcoholUnits to AlcoholInformation class. • WR 19-384 Section 5.62, Section 7.1: TradeItemDescriptionModule – Add new attribute tradeItemVariantStatement in the TradeItemVariant Class. • WR 19-386 Section 7.1: Change a set of attributes in MarketingInformationModule and TradeItemDescriptionModule to be TPN/TPD – tradeItemMarketingMessage, tradeItemFeatureBenefit, tradeItemKeyWords, tradeItemDescription. • WR 20-027 Section 5.37, Section 7.1: Add new attribute expressedAsPartOf to the NutrientDetail class of the NutritionalInformationModule. • WR 20-055 Section 5.14, Section 7.1: Add new attribute consumerRecyclingInstructions to the ConsumerInstructionsModule. 		Initial Draft for 3.1.14

<ul style="list-style-type: none"> • WR 19-288 Section 5.54: Change definition for attribute regulationLevelCodeReference in RegulatoryInformation class of RegulatedTradeItemModule. • WR 19-309 Section 5.5, Section 5.3, Section 5.32: <ul style="list-style-type: none"> ○ Update definitions to reflect future deprecation of attributes in AudienceOrPlayerInformationModule and HealthcareItemInformationModule. ○ Update datatype of attribute TargetConsumerAge from Description70 to Description500 - TargetConsumer class, MarketingInformationModule • WR 19-344: Post Global LCL for dietTypeSubcodes. Updated Section 6.2 to reflect the same. • WR 19-080, Section 5.20, Section 7.1: Add new attribute dietTypeMarkedOnPackage in the DietTypeInformation class of the DietInformationModule • WR 20-093, Section 5.41, Section 7.1: <ul style="list-style-type: none"> ○ Add new attributes – packagingLabellingTypeCode and packaging LabellingCoveragePercentage to the PackagingMaterial Class in the PackagingInformationModule. ○ Add new class PackagingRawMaterialInformation in the PackagingInformation Module ○ Add two new attributes in the PackagingRawMaterialInformation class – packagingRawMaterialCode and packagingRawMaterialContentPercentage ○ Add association from class CompositeMaterialDetail to PackagingRawMaterialInformation class • WR 20-069, Section 5.28: Change data type of the attribute compulsoryAdditiveLabelInformation of the HealthRelatedInformation class in HealthRelatedInformationModule from Description1000 to Description5000 • WR 19-346, Section 5.62, 6.1, 7.1: Add an attribute opacityTypeCode to TradeitemDescriptionInformation class in TradeitemDescriptionModule. Add datatype OpacityTypeCode. 		
<ul style="list-style-type: none"> • Updated section 7.1 for “isDietTypeMarkedOnPackaging” instead of “DietTypeMarkedOnPackaging”, • Added missing multiplicity (0..1) for “sDSSheetEffectiveDateTime” in section 5.55 • Removed a “c” in “packagingLabellingCoveragePercentage” in section 5.41 in packaging information module • In section 7.1 for expressedAsPartOf removed text “No” from Multiple Values and “Yes” from Multi Measurement made both fields blanks 		<p>Community Review Comments for 3.1.14 – 1.4.17</p>
<ul style="list-style-type: none"> • WR 20-020 Section 5.1, Section 7.1: Added the following new attributes to the AlcoholInformationModule: <ul style="list-style-type: none"> ○ beerStyleCode ○ alcoholBeverageFilteringMethodTypeCode ○ alcoholBeverageProductionMethodTypeCode ○ alcoholBeverageDistilledFromCode ○ primaryAddedFlavouringCode ○ secondaryAddedFlavouringCode ○ alcoholBeverageAge ○ isCaskStrength ○ alcoholBeverageTypeCode Added a new class AlcoholBeverageContainer to the AlcoholInformationModule and added the following new attributes in the new class: <ul style="list-style-type: none"> ○ containerTypeCode ○ containerProcessTypeCode 		<p>Initial Draft 3.1.15</p>

<ul style="list-style-type: none"> ○ containerShapeCode ○ containerMaterialCode • WR 20-041 Section 5.31, Section 7.1: added the following new attributes to the LightingDeviceModule <ul style="list-style-type: none"> ○ declaredPower ○ equivalentLightBulbPower ○ lightBulbWarmUpTime ○ isLightBulbSuitableForAccentLighting ○ minimumColourTemperature ○ maximumColourTemperature • WR 20-116 Section 3.18, Section 7.1: added a new attribute languageSpecificPartyName to PartyInRole in TradeItemCore • WR 19-079 Section 5.37, Section 7.1: added attribute claimMarkedOnPackage in the NutritionalInformationModule • WR 19-164 – (changes) <ul style="list-style-type: none"> ○ Section 5.37, updated definition for nutritionalClaim to include health claim ○ Section 5.29, updated the following definitions to indicate future deprecation in the HealthWellnessPackagingMarkingModule: <ul style="list-style-type: none"> ▪ packagingMarkedDietAllergenCode ▪ packagingMarkedFreeFromCode ○ Section 5.28 Update definition to indicate future deprecation in the HealthRelatedInformation <ul style="list-style-type: none"> ▪ healthClaimDescription ▪ healthClaimCode • WR 20-029 – (changes) <ul style="list-style-type: none"> ○ Section 5.35, section 7.1 updated definition for nonfoodIngredientStatement and update attribute to multivalue ○ Section 5.25, Section 7.1 update ingredientStatement in the FoodAndBeverageIngredientModule to FormattedDescriptio5000 and Multi Value • WR-20-237 – (Changes) <ul style="list-style-type: none"> ○ Section 5.33 update definition for MedicalDeviceTradeItemMoudle and MedicalDeviceInformation class to include Invitro Diagnostics • Added a new section: 7.2 - Divergence of section 7.1 (Class or Module variation) for TPN/TPD Please note: Any attributes of the ReferencedFileHeader class in the ReferencedFileDetailInformationModule are set to TPN/TPD not TPN. • Updated section 6.2 – Update dietTypeSubcode to make it a GDSN codelist and no longer an LCL and added chemicalIngredientScheme to the list as an LCL • Added a new section 8.2 Usage Disclaimer for The Unified Code for Units of Measure (UCUM) <p>WR 20-098 (EUDAMED) Adds -</p> <ul style="list-style-type: none"> • Section 4.1, Section 7.1: TradeItemCore • Created new class GlobalModelInformation and add following attributes: <ul style="list-style-type: none"> ▪ GlobalModelNumber ▪ globalModelDescription ▪ created an associaton from GlobalModelInformation to GlobalModelContactInformation from SharedCommon 		
---	--	--

<ul style="list-style-type: none"> • Created new class GlobalModelRegulatoryInformation and added the following attributes: <ul style="list-style-type: none"> ▪ globalModelRegulatoryAct ▪ globalModelRegulatoryActCountryCode ▪ Created an association from GlobalModelInformation to GlobalModelRegulatoryinformation class • Section 3.22, added new attributes to the StructuredAddress Class in TradeItemCore: complementAddress, poBox, streetNumber • Section 5.56, Section 7.1: added new class salesConditionTargetMarketCountry and added attributes to the salesConditionTargetMarketCountry: <ul style="list-style-type: none"> ▪ endAvailabilityDateTime ▪ startAvailabilityDateTime ▪ countryCode ▪ countrySubdivisionCode • Section , Section 7.1 - added the following attributes to the MedicalDeviceTradeItemModule in the MedicalDeviceInformationClass: <ul style="list-style-type: none"> ▪ annexXVIintendedPurposeTypeCode ▪ hasDeviceMeasuringFunction ▪ isActiveDevice ▪ isDeviceReagent ▪ isDeviceCompanionDiagnostic ▪ isDeviceDesignedForProfessionalTesting ▪ isDeviceInstrument ▪ isDeviceIntendedToAdministerOrRemoveMedicinalProduct ▪ isDeviceMedicinalProduct ▪ isDeviceNearPatientTesting ▪ isDevicePatientSelfTesting ▪ isDeviceExemptFromImplantObligations ▪ isNewDevice ▪ isReprocessedSingleUseDevice ▪ isReusableSurgicalInstrument ▪ multiComponentDeviceTypeCode ▪ specialDeviceTypeCode ▪ systemOrProcedurePackMedicalPurposeDescription ▪ systemOrProcedurePackTypeCode ▪ eUMedicalDeviceStatusCode ▪ uDIProductionIdentifierTypeCode ○ created a new class MedicalDeviceSubStatusInformation in the HealthCareTradeItemInformationModule and added the following attributes to the new class: <ul style="list-style-type: none"> ▪ deviceSubStatusEndDateTime ▪ deviceSubStatusStartDateTime ▪ eUMedicalDeviceSubStatusCode ▪ recallPrecision ▪ recallScope ○ created a new class ClinicalStorageHandlingInformation in the HealthCareItemInformationModule and added the following new attributes in the new class: <ul style="list-style-type: none"> ▪ clinicalStorageHandlingDescription ▪ clinicalStorageHandlingTypeCode ○ added two new attributes to the ClinicalSize call in HealthCareItemInformationModule: <ul style="list-style-type: none"> ▪ clinicalSizeMeasurementPrecisionCode ▪ clinicalSizeValueMaximum ○ added a new attribute warningsOrContraIndicationDescription to the 		
---	--	--

<p>ClinicalWarning class in the HealthCareItemInformationModule</p> <ul style="list-style-type: none"> ○ added two new attributes to the HealthCareItemInformation class in the HealthCareItemInformationModule: <ul style="list-style-type: none"> ▪ doesTradeItemContainMicrobialSubstance ▪ doesTradeItemContainAnimalTissue ○ added two new attributes to the RegulatedChemical class in the ChemicalRegulationInformationModule: <ul style="list-style-type: none"> ▪ carcinogenicMutagenicReprotoxicTypeCode ▪ regulatedChemicalTypeCode ○ added one new attribute certificationExecutionCountryCode to the Certification class in the CertificationInformationModule <p>Changes –</p> <ul style="list-style-type: none"> • Section 5.62, updated additionalTradeItemDescription from Description500 to Description2000 • Section 5.30, update definition for healthcareGroupedProductCode • Section 5.12, update regulatedChemicalDescription from Description1000 to Description2000 and update definition for regulatedChemicalName and change string1000 to string2000 • Section 3.8, in the CertificationInformationModule updated data types for: <ul style="list-style-type: none"> ▪ certificationValue (from string70 to string120) ▪ certificationIdentification (from string80 to string120) ▪ certificationStandard(from string80 to string120) • Section 3.22, update definition for attribute streetAddress in StructuredAddress class 		
<ul style="list-style-type: none"> • Update definition for containerTypeCode: from: Sherry But, Pin (Cask) to Sherry, Rum • Update attribute beerStyleCode from 0..1 to 0..*(change based on WR that was entered) • Added WR 19-220 - change nonfoodIngredientName to support multi-language • Updated definition for "certificationExecutionCountryCode" to add ISO3166_1 Code • Added WR – 19-203 - Updated the Health Related Information Module by moving the following attributed to a new class titled "NutritionalProgram" nutritionalProgramCode, nutritionalProgramDetail, nutritionalScore and nutritionalScore, also moved nutritionalProgramIngredientTypeCode and nutritionalProgramIngredientMeasurement to the new subclass titled "NutritionalProgramIngredients" • For the attribute nonfoodIngredientName updated datatype string to Description500 		<p>Community Review Comments for 3.1.15 – 1.4.22</p>
<ul style="list-style-type: none"> • Updated the following attributes from mandatory to optional: <ul style="list-style-type: none"> ○ clinicalSizeMeasurementPrecisionCode from the HealthcareItemInformationModule ○ carcinogenicMutagenicReprotoxicTypeCode from ChemicalRegulationInformation Module • Updated certificationValue and certificationStandard to {1..200} from {1..120} as errata 		<p>Errata WR 21-054 1.4.23</p> <p>March 2021</p>

<ul style="list-style-type: none"> • DairyFishMeatPoultryItemModule (WR-20-000144) <ul style="list-style-type: none"> ◦ Added cheeseMilkAcquisitionTypeCode to the CheeseInformation class • FoodAndBeveragePreparationServingModule, added the following attributes to the new class ProductPreparation TextureInformation (WR-20-000311): <ul style="list-style-type: none"> ◦ productTextureAgencyCode ◦ productTextureCode ◦ productTexturalCharacteristics • MarketingInformationModule (WR-20-000241) <ul style="list-style-type: none"> ◦ Added imitationOrSubstituteFor to the MarketingInformation class • RegulatedTradeItemModule (WR-20-000241) <ul style="list-style-type: none"> ◦ Added regulationPictogramOrWarningQuantity to the RegulatoryInformation class • SalesInformationModule (WR-20-000240) <ul style="list-style-type: none"> ◦ Updated definition for tradeItemPriceTypeCode • TextileMaterialModule added the following attributes to the TextileMaterial and TextileMaterialComposition class (WR-20-000385m WR-20-000383): <ul style="list-style-type: none"> ◦ tradeItemMaterialDesignationCode ◦ materialDensityCode ◦ threadDenier • TradeItemLicensingModule (WR-20-000385) <ul style="list-style-type: none"> ◦ Added licenseCode to the TradeItemLicenseDetail class • TradeItemMeasurementModule (WR-20-000383) <ul style="list-style-type: none"> ◦ Added diameter to the AdditionalTradeItemDimensions class • PackagingMarkingModule (WR-21-000007) <ul style="list-style-type: none"> ◦ Updated definition for tradeItemDateOnPackagingFormatName • Created a new module ProductInformationModule and added the following attributes (WR-20-000248): <ul style="list-style-type: none"> ◦ formationTypeCode ◦ hairProductFunctionOrTreatmentCode ◦ targetHairTypeCode ◦ naturalHairColourCode ◦ timeOfApplicationCode ◦ skinProductFunctionOrTreatmentCode ◦ targetSkinTypeCode ◦ dentalProductFunctionCode ◦ garmentlinedCode ◦ garmentLengthTypeCode ◦ garmentLegTypeCode ◦ garmentAdornmentTypeCode ◦ jewelryStyleCode ◦ jewelrySetContentsCode ◦ hosierySockRiseCode ◦ hosierySockStyleCode ◦ heelStyleCode ◦ hatTypeCode • Updated section 6.2 with: <ul style="list-style-type: none"> ◦ materialDensityCode (Textiles) ◦ materialCode (Heel) 		<p>Initial Draft 3.1.16</p>
<ul style="list-style-type: none"> • Updated definition for tradeItemPriceTypeCode, removed extra text "for item" • Update spelling for class "ProductPreparationTextureInformation" Preparation is spelled incorrectly • Updated definition for hairProductFunctionOrTreatmentCode added the word "hair" in front of product branding to be more specific 		<p>Community Review Comments for 3.1.16 – 1.4.25</p>

<ul style="list-style-type: none"> • Update the AlcoholInformationModule for WR-21-000033 and WR-21-000095 add the following attributes to the AlcoholInformation Class: <ul style="list-style-type: none"> ○ alcoholicBeverageColourCode ○ bitternessOfBeerMeasurement ○ originOfWineCode ○ percentageOfAlcoholByVolumeMeasurementPrecisionCode ○ sweetnessLevelOfAlcoholicBeverageCode • Update the FarmingAndProcessingInformationModule for WR-21-000058 and WR-21-000057 add the following attributes to the FarmingAndProcessingInformation class: <ul style="list-style-type: none"> ○ bioengineeredDeclarationClaimCode ○ isBioengineeredDeclarationClaimRelevantDataProvided • Update the MarketingInformationClass for WR-21-000033 add the following attributes to the new class BasicTasteInformation: <ul style="list-style-type: none"> ○ strongnessOfBasicTasteCode ○ typeOfBasicTasteCode • Update the NutritionalInformationModule for WR-21-000010 to add 1 attribute isNutrientOnFrontOfPackage • Update attribute regulationLevelCodeReference in the RegulatedTradeItemModule for WR-20-000396 to be repeatable values also updated in section 7.1 Attribute Variations • Update SalesInformationModule for WR-21-000094 to add 1 new attribute consumerSalesConditionMaximumAmount in the TargetMarketSalesConditions class • Update the ProductInformationModule for WR-20-000420 and WR-20-000429 with the following new classes and attributes: <ul style="list-style-type: none"> ○ Add a new Class <u>ApparelDetail</u> in the ProductInformaion class and add the following attributes: <ul style="list-style-type: none"> ▪ apparelDetailApplicationCode ▪ apparelDetailPlacementCode ▪ apparelDetailSizeCode ▪ apparelDetailTypeCode ○ Update the <u>ApparelProductInformation</u> class with the following attributes: <ul style="list-style-type: none"> ▪ neckwearTypeCode ▪ pantsShortsTypeCode ▪ skirtTypeCode ▪ sweaterPulloverTypeCode ▪ waistbandTypeCode ▪ waistRiseCode ○ Add a new class <u>HouseholdAndOfficeFurnishingInformation</u> to the Product information class ○ Add a new class <u>HouseholdOfficeFurnishing</u> to the HouseholdAndOfficeFurnishingInformation class and add the following attributes: <ul style="list-style-type: none"> ▪ pillowShapeCode ▪ rugTypeCode ▪ tablewareTypeCode ○ Add a new class <u>CleaningAidsInformation</u> to the HouseholdAndOfficeFurnishingInformation class and add the following attributes: <ul style="list-style-type: none"> ▪ brushBroomTypeCode ▪ cleaningClothTypeCode ▪ householdCleaningProductTypeCode ▪ laundryDetergentTypeCode ▪ laundryHangingAidTypeCode ▪ spongeScourerTypeCode 		<p>Initial Draft 3.1.17</p>
--	--	---------------------------------

<ul style="list-style-type: none"> ○ Add a new class <u>LinenInformation</u> class to the HouseholdAndOfficeFurnishingInformation class and add the following attributes: <ul style="list-style-type: none"> ▪ towelTypeCode ○ Update the <u>JewelryProductInformation</u> class with the following attributes: <ul style="list-style-type: none"> ▪ necklaceTypeCode ▪ ringTypeCode ▪ watchCaseShapeCode ○ Update the <u>ProductInformationDetail</u> class and add the following attributes: <ul style="list-style-type: none"> ▪ dispenserTypeCode ▪ seamsCode ▪ sportCode ▪ targetSurfaceTypeCode ○ Update the <u>FootwearProductInformation</u> class and add the following attributes: <ul style="list-style-type: none"> ▪ footwearOutsoleTypeCode ▪ footwearStyleCode ▪ toeStyleTypeCode ○ Updated section 7.1 Attribute Variations for all new attributes 		
<ul style="list-style-type: none"> • Added two new attributes to the FoodAndBeveragePropertiesInformationModule for (WR-21-000159) <ul style="list-style-type: none"> ○ microbiologicalOrganismMethodOfAnalysisCode ○ microbiologicalOrganismMinimumValue • WR-21-000158 - Updated section 7.1 for attribute 'returnablePackageDepositAmount' to be TPN/TPD • Updated section 3.2 (Codes) to add new added code BioengineeredDeclarationClaimCode to the code class diagram • Attributes: alcoholicBeverageColourCode contains "... by a a scale ..." (2x a) update to remove one 'a' • Attribute: laundryDetergentTypeCode contains color instead of colour, update spelling of color to colour 	3.1.17	Community Review Comments for 3.1.17 – 1.4.27
<ul style="list-style-type: none"> • Updated bitternessOfBeerMeasurement to: Multi Measurement =Yes and Multi Values =No (version of BMS did not update, only date) 	3.1.17	Errata 10/2021

<ul style="list-style-type: none"> WR-21-000187 Updated the MedicalDeviceInformationModule to add a new attribute 'isTradeItemUDIDIlevel' to the MedicalDeviceInformation class WR-21-000214 – In the AdditionalTradeItemDimensions Class update the following attributes to be 0..* <ul style="list-style-type: none"> depth height width grossWeight WR-21-000202 – Update definition for 'regulatoryActComplianceLevelCode' in the RegulatedTradeItem Module to be more generic WR-21-000187 - Updated TradeItemCore to add a new attribute 'isTradeItemAnUnitOfUse' to the TradeItem class WR-21-000032 – In GDSN common under ReferencedFileInformation updated the attribute 'contentDescription' from length Description70 to Description200 <p><u>Old Work requests:</u></p> <ul style="list-style-type: none"> WR-19-000080 – Marked attribute 'packagingMarkedDietAllergenCode' as deprecated from the HealthWellnessPackagingMarking class in the HealthWellnessPackagingMarkingModule and removed it from the table WR-18-000356 – Create a new class in the PackagingInformationModule and move three attributes to the new class: <ul style="list-style-type: none"> shippingContainerTypeCode (In PackagingInformationModule, at Module level) shippingContainerQuantity (In PackagingInformationModule, in class Packaging) shippingContainerQuantityDescription (In PackagingInformationModule, in class Packaging) WR-12-000143 & WR-12-000294 – Add a new attribute 'brandDistributionTradeItemTypeCode' to the Sales Information Module in the Salesinformation class 	<p>3.1.19</p>	<p>Initial Draft 3.1.19 1.4.28</p>
<ul style="list-style-type: none"> Update attribute "isTradeItemAnUnitOfUse" in section 7 to be "isTradeItemAnUnitofUse" instead of "isTradeItemAUnitofUse" Updated attribute from "isTradeItemAnUnitofUse" to "isTradeItemUnitofUse to"remove the "An" as discussed on the GMD-SMG call 11/16/2021 	<p>3.1.19</p>	<p>Community Review Comments for 3.1.19 – 1.4.29</p>
<ul style="list-style-type: none"> Add 3 new attributes to the DairyFishMeatPoultryItem Moulde in the CheeseInformation class for WR-21-000395 <ul style="list-style-type: none"> cheeseMoisturePercentage cheeseRipeningProcessCode firmnessOfCheeseCode Add 1 new attribute to the HealthRelatedInformation Module in the NutritionalProgram class for WR-21-000339 <ul style="list-style-type: none"> nutritionalProgramStatusCode Add 1 new attribute to the LightingDevice Module in the LightBulbInformation class for WR-21-000358 <ul style="list-style-type: none"> lightBeamTypeCode Update the definition for 2 attributes in the AllergenInformation Module to reflect deprecation in a future release for WR-21-000360 <ul style="list-style-type: none"> allergenSpecificationAgency allergenSpecificationName Update the length for attribute preparationInstructions from Description2500 to Description5000 in the FoodAndBeveragePreperationServing Module for WR-21-000357 Updated section 7.1 to reflect all newly added attributes 	<p>3.1.20</p>	<p>Initial Draft 3.1.20 1.4.30</p>

<ul style="list-style-type: none"> Update attribute nutritionalProgramStatusCode from TPN/TPD to TPN only 	3.1.20	Community Review Comments for 3.1.20 – 1.4.31
<ul style="list-style-type: none"> Added 1 new attribute cheeseTypeCode to the Cheese Information Class in the DairyFishMeatPoultryItem Module for WR-21-000437 Added 2 new attributes, meatPoultryCut and minimumAmountOfAnimalProtein to the FishMeatPoultryContent class in the DairyFishMeatPoultryItem Module for WR-21-000388 Added 1 new attribute isGradedBeforePreparationTypeApplied to the PreparationServing class in the FoodAndBeveragePreparationServing Module for WR-21-000388 Added 1 new attribute isClaimRegulated to the NutritionalClaimDetail class in the NutritionalInformation Module for WR-21-000390 Added 1 new attribute saltMoistureContentCode to the DairyFishMeatPoultryInformation class in the DairyFishMeatPoultryItem Module for WR-21-000397 Added 1 new attribute ingredientCode to the FoodAndBeverageIngredient class in the FoodAndBeverageIngredient Module for WR-22-000056 Added 1 new attribute tradeItemSustainabilityStatement to the SustainabilityInformation class in the Sustainability Module for WR-22-000044 WR-22-000032 Added a new class CompulsoryAdditionalLabelInformation and 2 new attributes to the CompulsoryAdditionalLabelInformation class in the HealthRelatedInformation Module <ul style="list-style-type: none"> compulsoryAdditionalLabelInformation compulsoryAdditionalLabelInformationTypeCode 	3.1.21	Initial Draft 3.1.21 1.4.32
<ul style="list-style-type: none"> Update class name CompulsoryAdditionalLabelInformation to compulsoryAdditionalInformation 	3.1.21	Community Review comments for 3.1.21 – 1.4.33
<p><u>For WR 21-000304</u></p> <ul style="list-style-type: none"> Add 4 new attribute to the AnimalFeedingModule <ul style="list-style-type: none"> animalFoodTypeCode animalFoodProcessOrStateTypeCode animalTargetedHealthConditionCode animalTargetBreed Add 2 new attributes for the Animal Feeding class in the AnimalFeeding Module <ul style="list-style-type: none"> feedLifestageCode animalTargetSizeCode Create a new class PackagingRecyclabilityAssessmentInformation to the PackagingInformation Module and add 3 new attributes to the class for WR 22-000141 <ul style="list-style-type: none"> packagingRecyclabilityAssessmentSpecificationCode packagingRecyclabilityValue packagingRecyclabilityValueEffectiveDate <p><u>For WR 21-000449</u></p> <ul style="list-style-type: none"> Create a new class CleaningDisinfectingInformation in the ConsumerInstructions Module and add 4 new attributes to the class <ul style="list-style-type: none"> isPreCleaningNecessary 	3.1.22	Initial Draft 3.1.22 1.4.34

<ul style="list-style-type: none"> ○ typeOfCleaningCode ○ typeOfCleaningDisinfectionProcessCode ○ typeOfDisinfectionCode • Add a new attribute requiredEducationTrainingTypeCode in the ConsumerInstructions class in the ConsumerInstructions Module • Add a new attribute isProductResistantToSurfaceTensionReducingAgent in the MedicalDeviceInformation class in the MedicalDeviceTradeItem Module • Add a new attribute typeOfWasteCode in the TradeItemDisposalInformation class in the TradeItemDisposalInformation Module • Add a new attribute perfumeFragranceDilutionClassCode to the BeautyPersonalCareHygieneDetail class in the ProductInformation Module for WR 22-000090 • Add 4 new attributes to the ReferencedFileInformation class in ReferencedFileDetailInformation Module for WR – 22000040 <ul style="list-style-type: none"> ○ imageFacingCode ○ imageStateCode ○ isImageRendered ○ imageOrientationTypeCode <u>For WR-22-000067</u> • Add 2 new attribute to the PackagingMaterial Class in the PackagingInformation Module <ul style="list-style-type: none"> ○ packagingMaterialElementCode ○ packagingMaterialRecyclingSchemeCode • Add 1 new attribute, compositePackagingMaterialRecyclingSchemeCode to the CompositeMaterialDetail Class in the PackagingInformation Module 		
<ul style="list-style-type: none"> • WR-22-000166 – Update attribute additionalTradeItemClassificationCodeDescription from Trade Item Core in the AdditionalTradeItemClassificationValue class to string200 from description200 to support additional languages. Please note: due to this change this will require a technical VR. • WR-22-000262 – Add two new attributes certificationStatementOnPackage and subjectOfCertificationDescription to the Certification class in the CertificationInformation Module <ul style="list-style-type: none"> ○ Definitions for certificationValue and certificationStandard were updated. • WR-22-000280 – Add a new attribute catchCountryCode to the FishCatchInformation class in the DairyFishMeatPoultryItem Module • WR-22-000282 – Add a new attribute fishSeafoodPresentationCode to the FishReportingInformation class in the DairyFishMeatPoultryItem Module <ul style="list-style-type: none"> ○ Same WR. Update the definition of attribute tradeItemConditionCode in the SalesInformation Module <p><u>Addition of old WRs in 3.1.23:</u></p> <ul style="list-style-type: none"> • WR 15-000239 - Update the name of TextileMaterialModule module to MaterialModule and associated classes in the module should be updated to remove the work 'textile' <ul style="list-style-type: none"> ○ Expand the datatype of attribute materialCode from string {1..35} to {1..80} ○ Section 6.2 (Attributes with Code Lists Not Specified in Models) reflects materialCode • WR 17-000220 - Merge Size attributes from 3 different modules to TradeItemSizeModule 	<p>3.1.23</p>	<p>Initial Draft 3.1.23 1.4.35</p>

<ul style="list-style-type: none"> ○ Move class NonPackagedSizeDimension to TradeItemSizeModule ○ Move attribute sizeGroupCode from Apparel Module and add to TradeItemSizeModule ○ Move attribute descriptiveSize to descriptiveSizeDimension <ul style="list-style-type: none"> ▪ Expand descriptiveSizeDimension from Description70 to Description80 and update multiplicity to 0..* ▪ Update multiplicity for sizeDimension to 0..* • WR 19-000079 – WR 19-000164 - Move the 5 attributes from Nutritional Information Module to Product Information Module rename two in the process, see full breakdown below: <ul style="list-style-type: none"> ○ Nutritional claim detail class move the full class to Production information Module in the newly created class 'ClaimDetail': <ul style="list-style-type: none"> ▪ claimMarkedOnPackage Move to ProductInformationModule ▪ isClaimRegulated move to ProductInformationModule ▪ nutritionalClaimTypeCode (rename) to claimTypeCode then move to ProductInformationModule ▪ nutritionalClaimNutrientElementCode (rename) to claimElementCode then move to ProductInformationModule ○ Nutritional Information Module move to Product Information Module in the Product Information Detail Class: <ul style="list-style-type: none"> ▪ nutritionalClaim (rename) to claimDescription and then move to ProductInformationModule in the Product Information Detail class ○ Updated section 7.5 to reflect the following deleted attributes: <ul style="list-style-type: none"> ▪ healthClaimCode ▪ packagingMarkedDietAllergenCode ▪ packagingMarkedFreeFromCode ▪ healthClaimDescription • Removed class in BMS: <ul style="list-style-type: none"> ○ Removed Section 3.17 NonPackagingSizeDimension from common as this class is now moved to TradeItemSizeModule ○ Class associations to NonPackagedSizeDimension was also removed from ApparelInformationModule and TradeItemMeasurementsModule. ○ Class NutritionalClaimDetail in NutritionalInformationModule has been removed and added in the ProductInformation Detail 		
<ul style="list-style-type: none"> • Updated diagram name for TextileMaterialModule to MaterialModule • Corrected Typos for Dimension • Removed all reference to deleted attributes from section 7.1 	3.1.23	Community Review comments for 3.1.23 – 1.4.36
<ul style="list-style-type: none"> • Add a new attribute to sizeCode to the NonPackagedSizeDimension in the TradeItemSizeModule • Made minor update to claimMarkedOnPackage definition to update depreciated attributes • Updated multiplicity of attribute materialWeight from 0..1 to 0..* from class TradeItemMaterial (common) and class MaterialComposition class in Material Module 	3.1.23	Updated due to internal findings for 3.1.23 – 1.4.37

<ul style="list-style-type: none"> • WR-22-000278 – Add a new attribute typeOfProductChangesAfterDateCode to the PackagingDate class in the PackagingMarking Module • Update definition for 2 existing attributes in the fishCatchInformation class belonging to the DairyFishMeatPoultryItem Module: <ul style="list-style-type: none"> ○ catchMethodCode ○ productionMethodForFishAndSeaFoodCode 	3.1.24	Initial Draft 3.1.24 1.4.38
<ul style="list-style-type: none"> • WR-23-000026 – Update definition for attribute initialManufacturerSterilisationCode in the MedicalDeviceTradeItem Module • WR-23-000029 – Update definition for attribute maximumReusableDays in the MedicalDeviceTradeItem Module • WR-23-000028 – Update definition for attribute displayResolutionCode in the VideoDisplayDeviceInformation Module • WR-23-000032 – Add a new attribute nutrientNameOnPackage in NutrientDetail Class in NutritionalInformation Module of datatype Description200 	3.1.25	Initial Draft 3.1.25 1.4.39
<ul style="list-style-type: none"> • WR-23-000026 Updated definition to for initialManufacturerSterilisationCode to “Declaration of sterilisation, including not sterilised, which may have been performed by the manufacturer. Sterilisation refers to any process that effectively kills or eliminates transmissible agents (such as fungi, bacteria, viruses, prions and spore forms etc.) from a surface, equipment, foods, medications, or biological culture medium. Some methods of sterilization are through the application of heat, radiation, and ethylene.” • Update section 6.2: Attributes with Code Lists Not Specified in Models to add - MaterialCode (Lining) and remove - materialDensityCode (Textiles) 	3.1.25	Update after ComRev 1.4.40
<ul style="list-style-type: none"> • WR-23-000032 – Add a new class SustainabilityProgramInformation to the SustainabilityModule. Add 3 new attributes to the SustainabilityProgramInformation class in the SustainabilityModule <ul style="list-style-type: none"> ○ sustainabilityScore ○ sustainabilityProgramCode ○ sustainabilityValue 	3.1.26	Initial Draft 3.1.26 1.4.41
<ul style="list-style-type: none"> • WR-23-000013 – Added a new class RawMaterialInformation to the MaterialModule and add 2 new attributes to the class: <ul style="list-style-type: none"> ○ rawMaterialContentPercentage ○ rawMaterialCode • Added a new class PackagingClaims to the PackagingInformationModule and add 4 new attributes to the class: <ul style="list-style-type: none"> ○ packagingClaimElementCode ○ isPackagingClaimMarkedOnPackage ○ isPackagingClaimRegulated ○ packagingClaimTypeCode • WR-23-000013 – Updated definition for attribute packagingRawMaterialContentPercentage and packagingRawMaterialCode in the PackagingInformationModule under PackagingRawMaterialInformation class <ul style="list-style-type: none"> ○ Update definition for attribute materialWeight in the MaterialModule under MaterialComposition class • WR-23-000087 – Added 3 new classes to the ProductInformationDetail class In the ProductInformation Module: <ul style="list-style-type: none"> ○ CannabinoidContentInformation ○ CannabisInformation 	3.1.27 Large release	Initial Draft 3.1.27 1.4.42

<ul style="list-style-type: none"> ○ TobaccoCannabisInformation • Added 2 new attributes to the CannabisInformation: <ul style="list-style-type: none"> ○ cannabinoidTypeCode ○ cannabisCBDTypeCode • Added 3 new attributes to the CannabinoidContentInformation class: <ul style="list-style-type: none"> ○ cannabinoidContentCode ○ cannabinoidMinimumRangeValue ○ cannabinoidMaximumRangeValue • Add 3 new attributes to the MaterialModule in the Material class: <ul style="list-style-type: none"> ○ canMaterialsBeSeparatedManually ○ isDesignationIntendedForSingleUse ○ numberOfDesignationUnits • Updated definition for attribute cannabisCBDTypeCode in the HealthRelatedInformation class in the HealthRelatedInformation Module • WR-23-000089 - Added a new class TerpeneInformation to the ProductInformationDetail class in the ProductInformationModule and add 3 new attributes <ul style="list-style-type: none"> ○ terpeneTypeCode ○ maximumTerpeneContent ○ minimumTerpeneContent • WR-23-000093 – Added a new attribute numberOfPackagingElementUnits to the PackagingMaterial class in the PackagingInformationModule • WR-23-000097 – Added 3 new attributes to the PackagingInformationModule Module in the packagingMaterial class • WR-23-000115 – Added a new attribute extractionProcessCode to the FarmingAndProcessingInformation class in the FarmingAndProcessingInformationModule • Added a new attribute driedEquivalent to the FoodAndBeverageIngredient module and in the NonfoodIngredient module • WR-23-000140 – Added a new class CannabisPlantInformation to the ProductInformationModule and add 3 new attributes to the class: <ul style="list-style-type: none"> ○ isCannabisPlantAHybrid ○ cannabisPlantTypeCode ○ cannabisCommonName • WR-23-000147 – Added a new attribute microbiologicalOrganismStrainCode to the MicrobiologicalInformation class in the FoodAndBeveragePropertiesInformationModule • WR-23-000151 – Add 2 new attributes growingLightConditionTypeCode and growthCycle to the FarmingAndProcessingInformation class in the FarmingAndProcessingInformationModule • WR-23-000175 – Add 2 new attributes flowerTrimmingMethodCode and floweringTriggerCode to the FarmingAndProcessingInformation class in the FarmingAndProcessingInformationModule • WR-23-000201 – Add a new attributes carrierSubstanceTypeCode to the FarmingAndProcessingInformation class in the FarmingAndProcessingInformationModule • WR-23-000203 – Update definition for attribute growingMethodCode in the FarmingAndProcessingInformationModule under FarmingAndProcessingInformation class • WR-23-000237 – Add 2 new attributes tradeItemGenderTypeCode and curingMethodDescription to the 		
--	--	--

<p>FarmingAndProcessingInformation class in the FarmingAndProcessingInformationModule</p> <ul style="list-style-type: none"> • Older WR added in Large release: 17-000302 - Rename existing attributes in the TradeItemInformation class in Trade item core <ul style="list-style-type: none"> ○ productVariantDescription > consumerProductVariantDescription ○ productVariantEffectiveDateTime > consumerProductVariantStartEffectiveDateTime ○ productVariantCancelledDateTime > consumerProductVariantCancelledDateTime ○ productVariantDiscontinuedDateTime > consumerProductVariantDiscontinuedDateTime 		
<ul style="list-style-type: none"> • Added missing attributes to the document (the following were added in the data model but were missing from the grid) <ul style="list-style-type: none"> ○ canMaterialsBeSeparatedManually ○ isDesignationIntendedForSingleUse ○ numberOfDesignationUnits 	Large 3.1.27	Updates after ComRev 1.4.43
<p>Updates made as errata Jan 22 2024</p> <ul style="list-style-type: none"> • Updated description length for attribute in the table cannabisCommonName from Description100 to Description250. PLEASE NOTE: This was only modified in the table, the data model is correct. • Updated multiplicity for attribute rawMaterialCode from 0..* to 0..1 PLEASE NOTE: This was only modified in the table, the data model is correct. 	Large 3.1.27	Updates for errata 1.4.43
<p>Updates for GDSN 3.1.28 (New Attributes and Efficient Code Lists)</p> <ul style="list-style-type: none"> • WR-23-0000033 – Formatted Description - Update class diagram for formatted Description section 3.3.1 • WR-23-0000153 – Add 1 new attribute medicalDeviceSoftwareCode to the MedicalDeviceInformation class in MedicalDeviceTradeItem module. • WR-23-0000321 – Add a new class SmokingAccessories to the ProductInformation Module and add attribute vapeDeviceTypeCode in the new class. • WR-23-0000256 – Add a new attribute cartridgeDeviceCompatibilityCode to the SmokingAccessories class in the ProductInformation Module and add a new attribute batteryDeviceCompatibilityStatement to the BatteryDetail class in the BatteryInformation Module • WR-23-0000339 – Add a new attribute vapingKitCompatibilityCode to the SmokingAccessories Class in the ProductInformation Module and Add a new attribute terpeneSourceCode to the TerpeneInformation Class in the ProductInformation Module • WR-23-0000301 – Add a new attribute dryingMethodTypeCode to the FarmingAndProcessingInformation class in the FarmingAndProcessingInformation module • WR-23-0000342 – Update the definition for attribute: UnitedNationsDangerousGoodsNumber • WR-24-0000003 – Extend the datatype length of attribute: tradeItemFeatureBenefit from FormattedDescription250 to FormattedDescription500 and update definition • WR-24-0000042 – Add a new attribute nutritionalScoreProductCategoryCode to the HealthRelatedInformation Module in the NutritionalProgram class 	3.1.28	1.4.44

<p>Updates for GDSN 3.1.29 (Small)</p> <p>WR-23-000099 – Add a new attribute isPackagingElementIntendedForFoodContact to the PackagingMaterial class in the Packaging Information Module</p> <p>WR-23-000192 – Add 2 new attribute minimumProcessTemperatureTimeSpan and maximumProcessTemperatureTimeSpan to the TradeItemTemperatureInformation class in the TradeItemTemperatureInformation module</p> <p>WR-23-000378 – Update the definition of attribute isTradeItemRegulationCompliant</p> <p>WR-23-000384 – Change the multiplicity of the attribute dangerousHazardousLabelSequenceNumber</p> <p>WR-23-000404 – Change the MultipleValues of the attribute brandMarketingDescription and tradeItemStory</p> <p>WR-23-000414 – Update the definition of attribute packagingLabellingCoveragePercentage</p> <p>WR-24-000013 – Add a new attribute packingProcessMethodCode to the ProductInformationDetail class in the ProductInformation Module</p>	<p>3.1.29</p>	<p>1.4.45</p>
<p>Updates for GDSN 3.1.31(Large)</p> <p>WR-23-000087 – Delete Attribute cannabisCBDTypeCode from HealthRelatedInformationModule</p> <p>WR-23-000380 – Add 1 new attribute isSupplierARegistrant to the DutyFeeTaxInformation Class in the DutyFeeTaxInformation Module</p> <p>WR-23-000388 – Add 1 new attribute materialDensity to the MaterialComposition class in Material Module</p> <p>WR-23-000401 – Increase size of the attribute netContentStatement to 1000 characters</p> <p>WR-23-000408 – Add one new attribute edibleFatTypeCode to the FishMeatPoultryContent class in the DairyFishMeatPoultryItemModule</p> <ul style="list-style-type: none"> • Add 2 new attribute animalCutCode and numberOfRibs to the DairyFishMeatPoultryItemMoudule in the FishMeatPoultryContent class • Add 2 new attribute animalCutCode and numberOfRibs to the DairyFishMeatPoultryItemMoudule in the FishMeatPoultryContent class • Add a new class ExternalAgriculturalQualityStandardInformation to the FarmingAndProcessingInformationModule and add 3 new attributes to the class: <ul style="list-style-type: none"> ○ externalAgriculturalQualityStandardAgencyCode ○ externalAgriculturalQualityStandardCategoryCode ○ externalAgriculturalQualityStandardCode • Update definition for 2 attributes in the FoodAndBeveragePreparationServingMoudle <p>WR-23-000412 – Add a new attribute multilayerFilmMaterialCompositionCode to the PackagingMaterial class in the PackagingInformationModule</p> <p>WR-23-000413– Make an association from AdditiveInformation (common) to the PackagingMaterial Class in the PackagingInformationModule</p> <p>WR-23-000418– Add a new attribute packagingMaterialDensity to the packagingInformationMaterial class in the packagingInformationModule</p> <p>WR-24-000039– Change descriptionShort length from 35 to 40 characters</p> <p>WR-24-000079– Update definitions for depth, height and width in the NonGTINLogisticsUnitInformation class, PackagingDimension class, TradeItemMeasurements class and the AdditionalTradeItemDimensions class to use the new name "GS1 Package and Product Measurement Standard" for more details see GDSN 3.1.31 PPT slide deck.</p> <p>WR-24-000082– Add a new attribute tradeItemVariantGroupCode to the TradeItemVariant class in the TradeItemDescription Module</p>	<p>3.1.31</p>	<p>1.4.46</p>

<ul style="list-style-type: none"> • Update definition for 2 attributes in the AlcoholInformation Module to identify future deprecation <ul style="list-style-type: none"> ○ primaryAddedFlavouringCode ○ secondaryAddedFlavouringCode <p>WR-24-00092– Add a new attribute nutrientGroupCode to the NutritionalInformation Module in the NutrientDetail Class</p> <p>WR-24-000103– Add two new attributes isContactInformationMarkedOnPackage and isCommunicationChannelMarkedOnPackage to the Trade Item Core level</p> <p>WR-24-000107– Update definition for claimElementCode and claimTypeCode attributes in the ProductInformation Module in the ClaimDetail class</p> <p>WR-24-000149– Add 8 New attributes to the new class added EndProductIngredientSchedule in the FoodAndBeverageIngredientModule</p> <ul style="list-style-type: none"> • fiscalYear • foodMaterialCode • foodMaterialDescription • inventoryDrawdownPerTradeItem • foodValueBasis • foodValueBasisTypeCode • foodValuePerTradeItem • regulatorApprovalDate <p>WR-24-000164– Add one new attribute resultingHairColourShadeCode to the HairProductInformation in the Product Information module</p> <p>WR-24-000167– Add 2 new attributes to the AlcoholInformation Class in the AlcoholInformation Module</p> <ul style="list-style-type: none"> • drinkingMaturityEndYear • drinkingMaturityStartYear <p>WR-24-000173– Add a new Attributes hairStyleFixationCode to the to the HairProductInformation class in the Product Information Module</p> <ul style="list-style-type: none"> • Add a new Attributes bristleHardnessCode to the to the DentalProductInformation class in the Product Information Module <p>WR-24-000199– Add 8 new attributes in the newly added class CarbonFootprintDetail in SustainabilityModule</p> <ul style="list-style-type: none"> • cfpCountryCode • cfpBoundariesCode • cfpValue • cfpFunctionalUnit • cfpMethodologyCode • cfpValueVerificationCode • cfpAccountingCode • cfpDate <p>WR-24-000244– Add an AVP extension to the PackagingMaterial class in the PackagingInformation Module</p>		
<p>Removed FoodInformation and all attributes within the class based on community review feedback:</p> <p>originCode, roastOfCoffeeCode, typeOfAddedCreamerWhitenerCode, typeOfConsumableCoffeeCode, typeOfGrindCode, typeOfTeaOrInfusionCode, varietyTypeCode</p>	<p>3.1.31</p>	<p>1.4.47 ComRev</p>